

Grub Screws• ball-headed
22570.0520

Product Description

For combination with plastic thrust pads EH 22570.



Material

- Stainless steel 1.4305

More information

Further products

- Thrust Pads, Plastic

Drawing

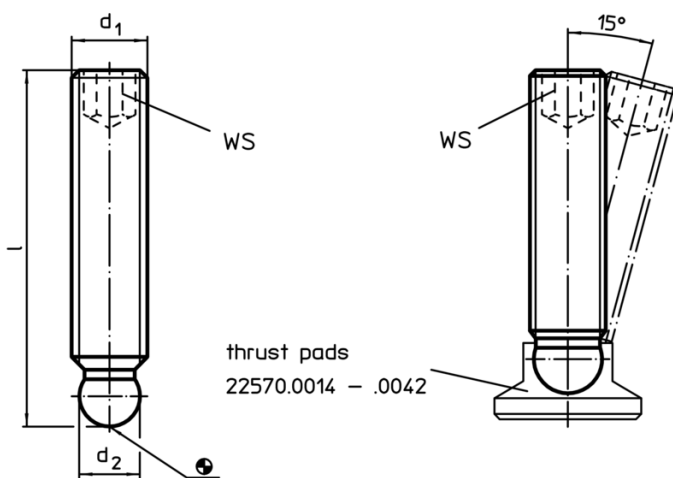

Order information

d ₁	Dimensions l [mm]	d ₂ +0,05	WS [mm]	 [g]	Art. No.
M12	63	9,4	6	39	22570.0520

Application example

