

Grub Screws• ball-headed
22570.0516

Product Description

For combination with plastic thrust pads EH 22570.

Material

- Stainless steel 1.4305

More information

Further products

- Thrust Pads, Plastic



Drawing

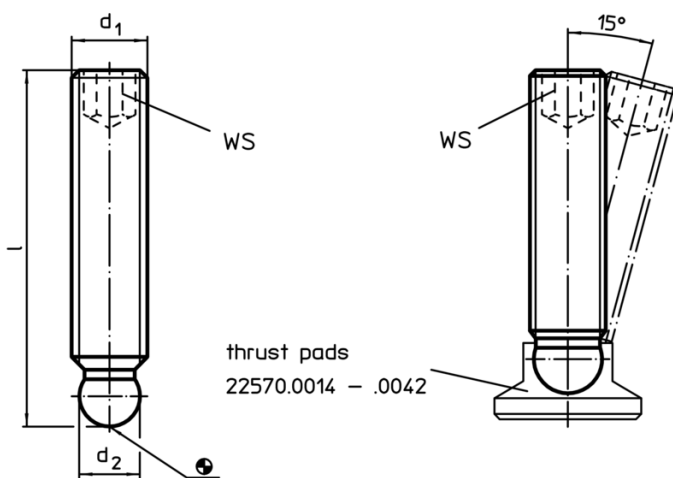

Order information

d_1	Dimensions l [mm]	d_2 +0,05	WS [mm]	 [g]	Art. No.
M12	40	9,4	6	23	22570.0516

Application example

