

Grub Screws• ball-headed 22570.0316

Product Description

For combination with plastic thrust pads EH 22570.

Material

- Free cutting steel, quality 5.8, blackened

More information

Further products

- Thrust Pads, Plastic



Drawing

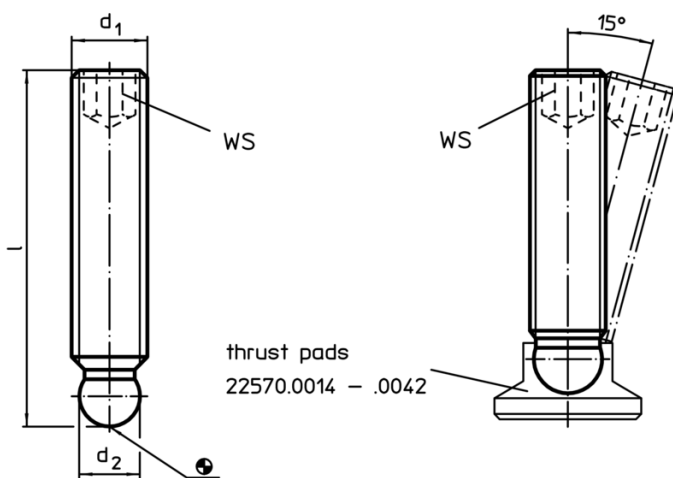

Order information

d ₁	Dimensions l [mm]	d ₂ +0,05	WS [mm]	 [g]	Art. No.
M12	40	9,4	6	23	22570.0316

Application example

