

Grub Screws• ball-headed 22570.0248

Product Description

For combination with plastic thrust pads EH 22570.

Material

- Free cutting steel, quality 5.8, blackened

More information

Further products

- Thrust Pads, Plastic



Drawing

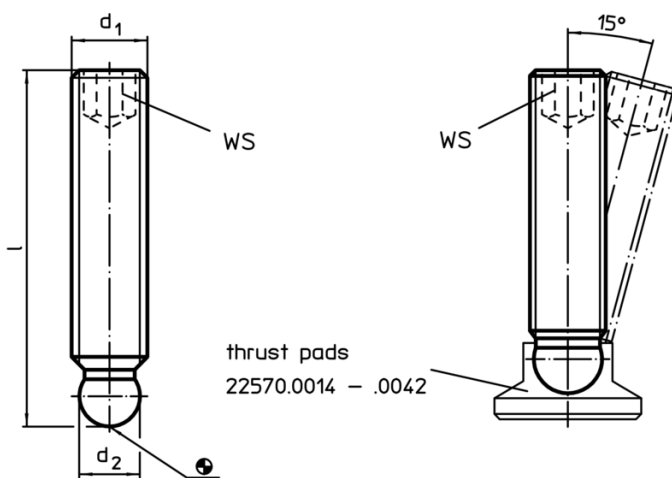

Order information

d_1	Dimensions l [mm]	d_2 +0,05	WS [mm]	 [g]	Art. No.
M10	40	7,8	5	16	22570.0248

Application example

