

Grub Screws• ball-headed
22570.0224

Product Description

For combination with plastic thrust pads EH 22570.

Material

- Free cutting steel, quality 5.8, blackened

More information

Further products

- Thrust Pads, Plastic



Drawing

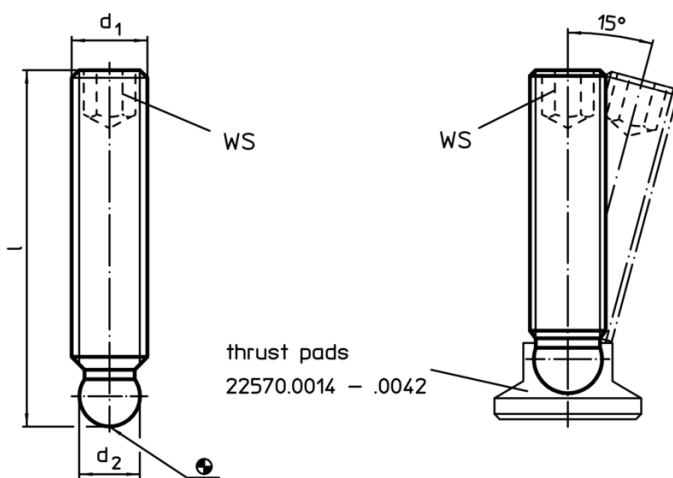

Order information

d ₁	Dimensions l [mm]	d ₂ +0,05	WS [mm]	 [g]	Art. No.
M8	50	6,1	4	14	22570.0224

Application example

