

Grub Screws• ball-headed
22570.0218

Product Description

For combination with plastic thrust pads EH 22570.

Material

- Free cutting steel, quality 5.8, blackened

More information

Further products

- Thrust Pads, Plastic



Drawing

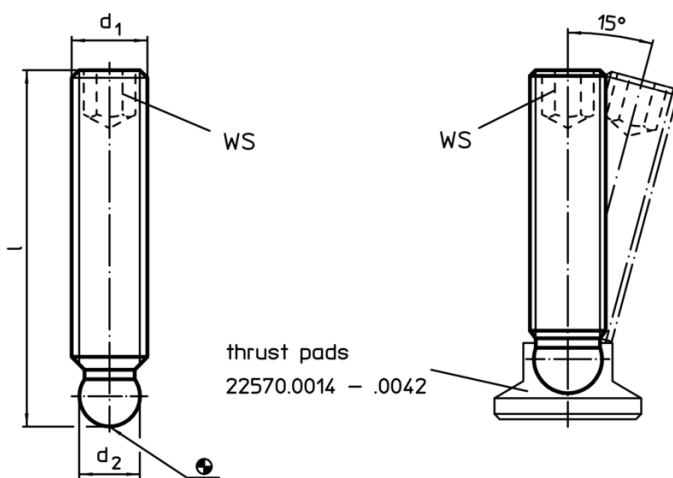

Order information

Dimensions			WS		Art. No.
d ₁	l [mm]	d ₂ +0,05	[mm]	[g]	
M6	50	4,47	3	7,6	22570.0218

Application example

