

Thrust Pads- Plastic
22570.0040



Product Description

For combination with ball-headed grub screws EH 22570.

Material

- Thermoplastic POM, black, dull

More information

Further products

- Grub Screws, ball-headed

Drawing

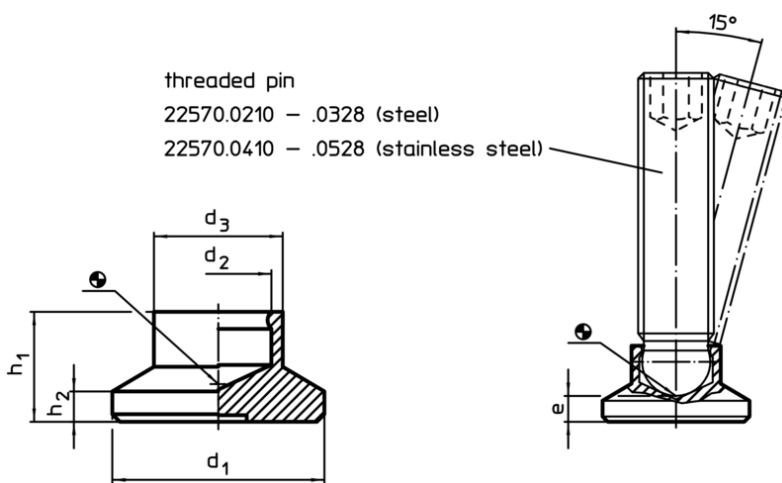

Order information

Dimensions						Load capacity for static load max.	For grub screws EH 22570.	Temperature		Weight	Art. No.
d ₁	d ₂	d ₃	e	h ₁	h ₂			min.	max.		
[mm]						[kN]	[mm]	[°C]		[g]	
40	6,1	16	8	13	4	3,5	M8	-30	80	11	22570.0040

Application example

