

Grub Screws• DIN 6332 with thrust point

22540.0462

Product Description

For combination with thrust pads with snap ring DIN 6311 form S, (EH 22560.) and clamping screws DIN 6332.



Material

- Steel, blackened, quality 5.8, thrust point hardened

More information

Further products

- Thrust Pads, DIN 6311 and low model

Drawing

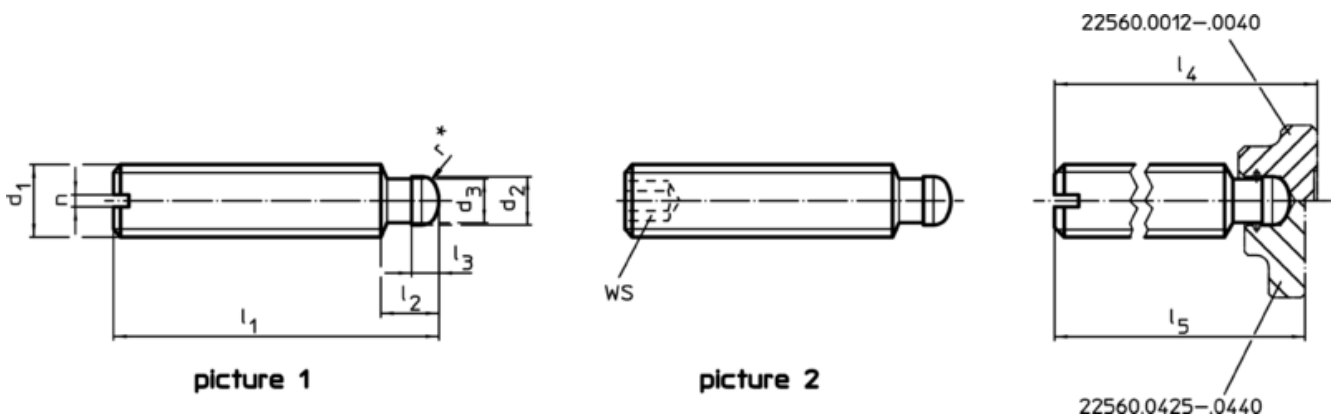

* to ease assembly the DIN 6332 specification has been completed by r

Order information

Dimensions								WS		Art. No.
d ₁	l ₁	d ₂ h11	d ₃	z ₂	z ₃	l ₂ ~	l ₃ ~	[mm]	[g]	
[mm]										
with internal hexagon (IS) – picture 2										
M16	100	12	11	12	5	105,4	102,9	8	118	22540.0462

Application example

