

Grub Screws• DIN 6332 with thrust point

22540.0082

Product Description

For combination with thrust pads with snap ring DIN 6311 form S, (EH 22560.) and clamping screws DIN 6332.



Material

- Steel, blackened, quality 5.8, thrust point hardened

More information

Further products

- Thrust Pads, DIN 6311 and low model

Drawing

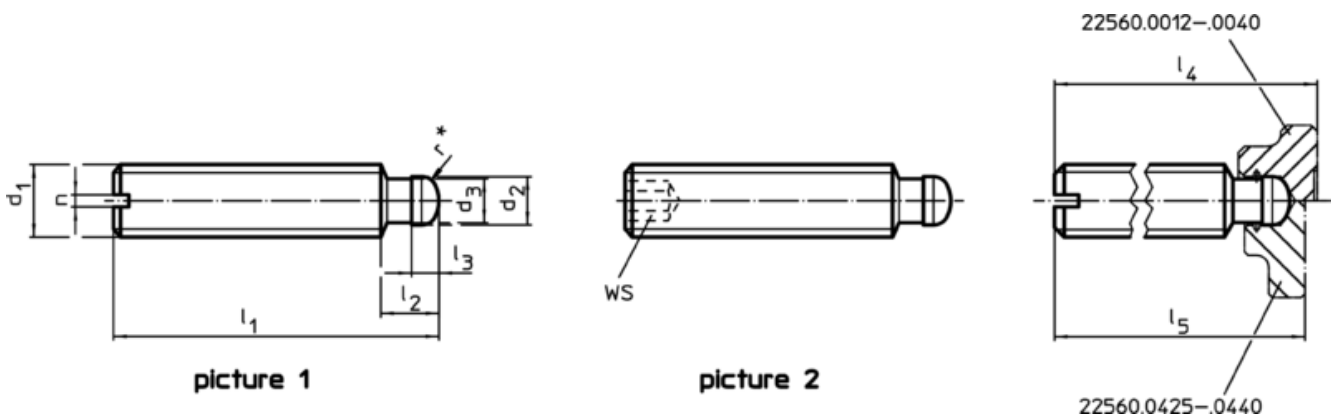

* to ease assembly the DIN 6332 specification has been completed by r

Order information

d ₁	l ₁	d ₂ h11	d ₃	Dimensions				n	[g]	Art. No.
				z ₂	z ₃	l ₂ ~	l ₃ ~			
slotted (S) – picture 1										
M8	60	6	5,4	7,5	3	63	62,5	1,2	17	22540.0082

Application example

