

## Retaining Cables

22400.0966



### Product Description

These retaining cables secure the single-acting ball lock pin EH 22340., EH 22350., EH 22370. and EH 22380., as well as clamping pin EH 22360., and socket pin EH 22400. against possible loss.

### Material

#### Attaching ring

- Stainless steel

#### Ring

- Stainless steel

#### Retaining cable

- Stainless steel

#### Coating retaining cable

- Thermoplastic PA 6 coated, clear

### Assembly

Attached holding clips (picture 5/6) to the ball lock pin with a soft-face mallet, disassemble via levering it with a screw driver.

Thermoplastic version (picture 7): cut-off projecting ends without burr after being fastened.

Spiral form design (picture 8) with very high effective working length.

### More information

### Notes

Special types on request.

Models picture 3 and picture 4 correspond to MIL-DTL-83420.

### Drawing

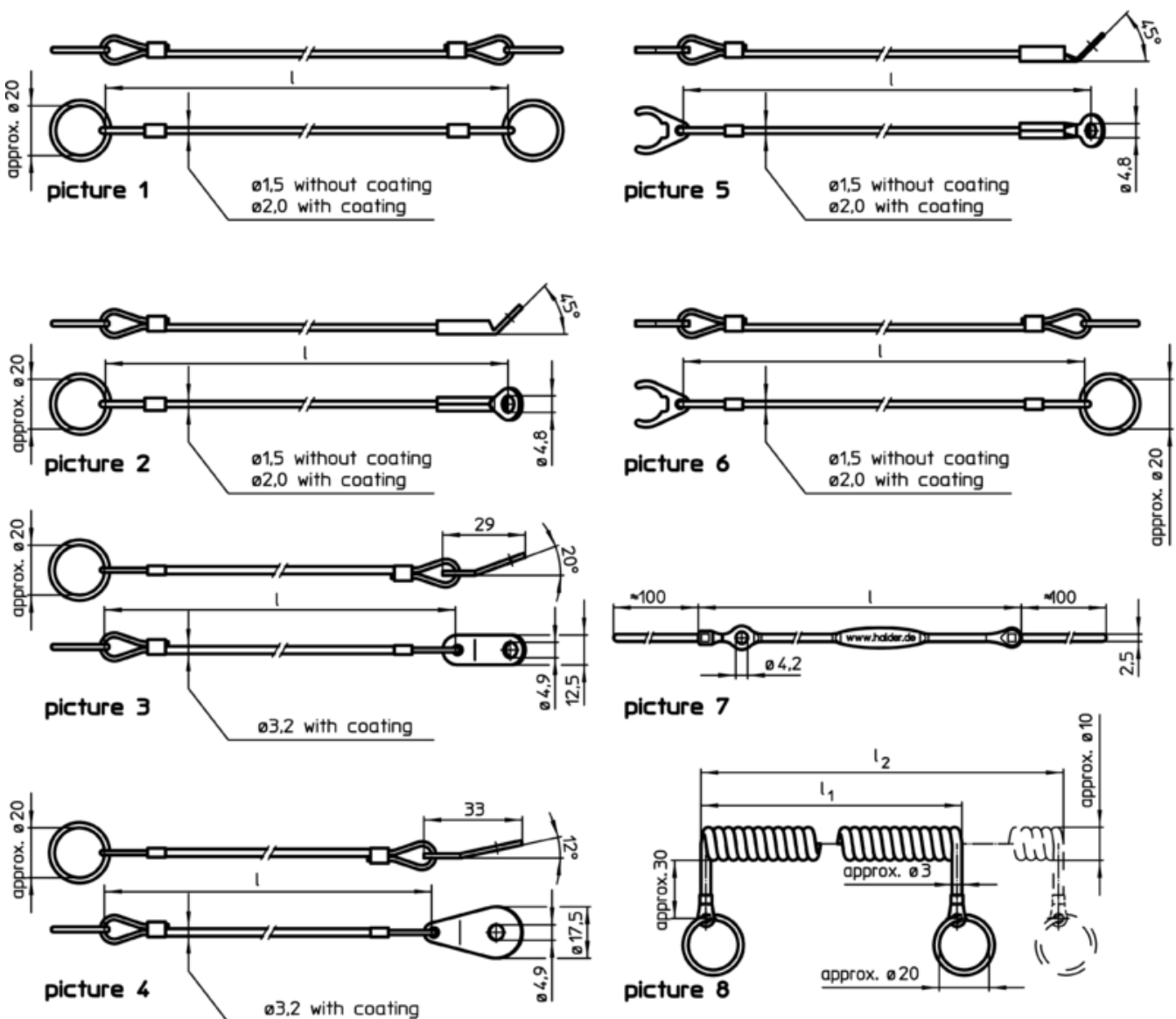

Order information

Dimensions l [mm]	max. [°C]	[g]	Art. No. <sup>1)</sup>
stainless steel, with holding ring and loop to be screwed – picture 2, Thermoplastic PA 6 coated, clear			
300	80	8,6	22400.0966

<sup>1)</sup> not for ball-lock pins, basic type

Application example

