

Retaining Cables

22400.0941



Product Description

These retaining cables secure the single-acting ball lock pin EH 22340., EH 22350., EH 22370. and EH 22380., as well as clamping pin EH 22360., and socket pin EH 22400. against possible loss.

Material

Attaching ring

- Stainless steel

Retaining cable

- Stainless steel

Coating retaining cable

- Thermoplastic PA 6 coated, black

Assembly

Attached holding clips (picture 5/6) to the ball lock pin with a soft-face mallet, disassemble via levering it with a screw driver.

Thermoplastic version (picture 7): cut-off projecting ends without burr after being fastened.

Spiral form design (picture 8) with very high effective working length.

More information

Notes



Special types on request.

Models picture 3 and picture 4 correspond to MIL-DTL-83420.

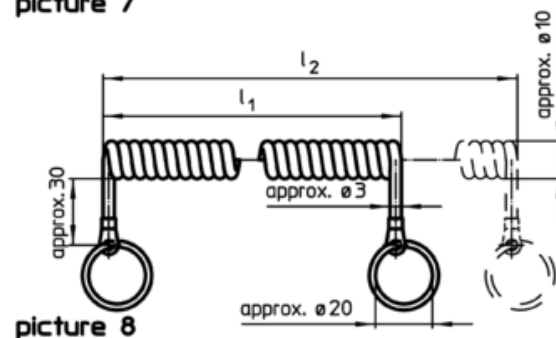
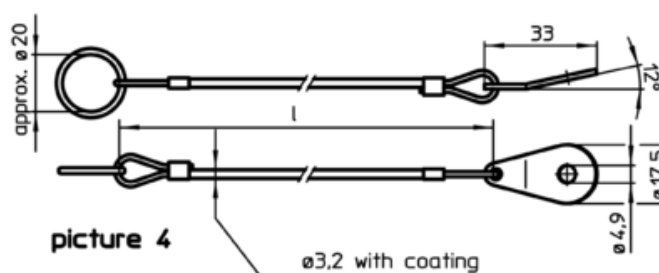
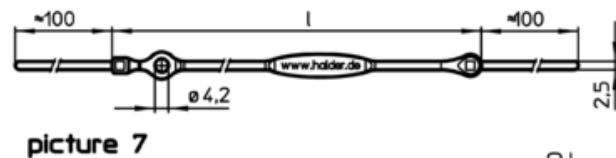
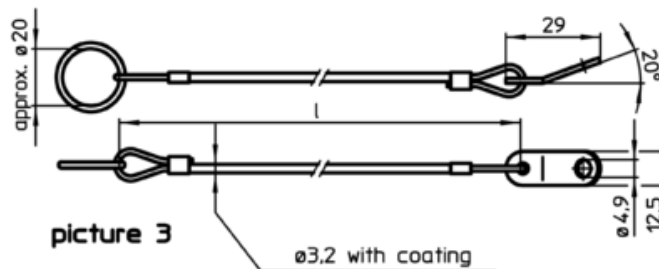
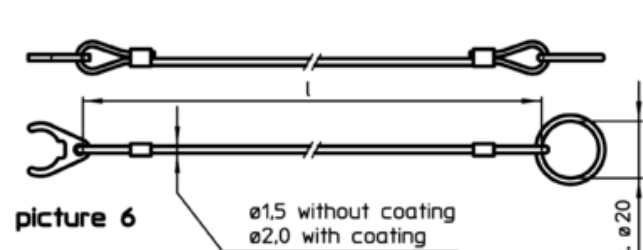
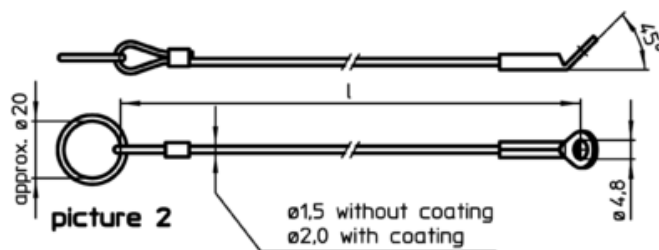
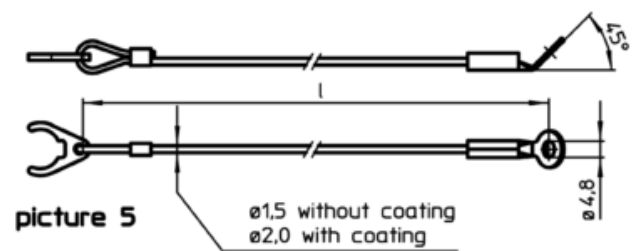
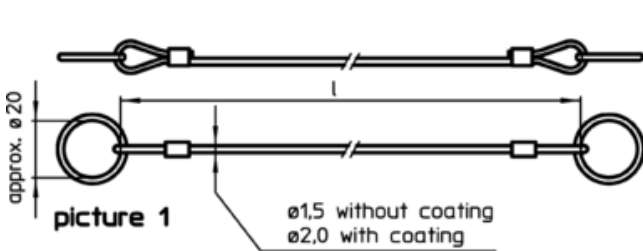
Drawing



Order information

Dimensions			Art. No. ¹⁾
l [mm]	max. [°C]	[g]	
stainless steel, with 2 holding rings – picture 1, Thermoplastic PA 6 coated, black			
200	80	6,4	22400.0941

¹⁾ not for ball-lock pins, basic type

Application example

