

## Socket Pins• with spring-loaded balls

22400.0084



### Product Description

For quick fastening, locking, adjusting, changing and securing. Quickly and easily unlockable for frequently repeated connections.

All versions are corrosion resistant.

Version with ergonomic grip.

### Material

#### Pin part

- Stainless steel 1.4305

#### Handle

- Thermoplastic PA 6, grey

#### Spring

- Stainless steel

### More information

#### Notes

Security Note: Balls are spring-loaded and not locked as in article groups EH 22340., EH 22350., EH 22360., EH 22370. and EH 22380.

#### Accessories

Can easily be fitted with retaining cable EH 22400.

#### Further products

- Locating Bushings, for ball lock pins and socket pins
- Locating Bushings, with flange, for ball lock pins and socket pins
- Retaining Cables
- Positioning Bushings, with collar
- Positioning Bushings, without collar

### Drawing

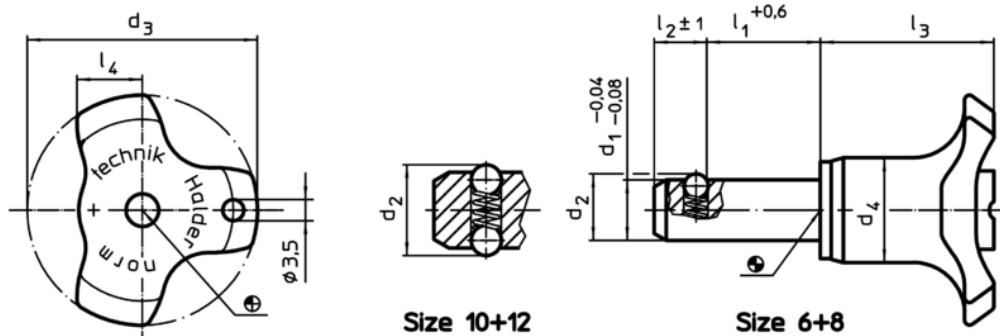

### Order information

Dimensions									Location hole H11	Shearing resistance, double	Tensile force max. unlubricated	Temperature		Weight	Art. No.
d <sub>1</sub>	l <sub>1</sub>	d <sub>2</sub>	d <sub>3</sub>	d <sub>4</sub>	l <sub>2</sub> ±1	l <sub>3</sub>	l <sub>4</sub>	min.				max.	[°C]		
-0,04 -0,08	+0,6								[mm]	[kN]	[N]				
8	15	8,7	38	17,3	6,3	28,6	10,8	8	40	15	-30	80	21	22400.0084	

Application example

