

Ball Lock Pins· self-locking, with combination handle, precipitation-hardened

22380.0808



Product Description

For quick fastening, locking, adjusting, changing and securing. Quickly and easily unlockable for frequently repeated connections.

All versions are corrosion resistant. When using stainless steel 1.4542: high-strength, hardened, abrasion resistant pin with high load capacity.

Ergonomic grip, different colour combinations available. The grip design provides protection of unintentional unlocking.

Material

Pin part

- Stainless steel 1.4542, precipitation-hardened

Handle

- Thermoplastic PA 6 black / black

Spring

- Stainless steel

Operation

The balls are unlocked by pressing the knob.

Characteristic

Types from stainless steel 1.4542 with marking below the balls.

More information

Notes

Special types on request.

References

Stainless steel 1.4305, see EH 22370.

Accessories

Can easily be fitted with retaining cable EH 22400.

Further products

- Ball Lock Pins, self-locking, with combination handle
- Locating Bushings, for ball lock pins and socket pins
- Locating Bushings, with flange, for ball lock pins and socket pins
- Retaining Cables
- Positioning Bushings, with collar
- Positioning Bushings, without collar

Drawing

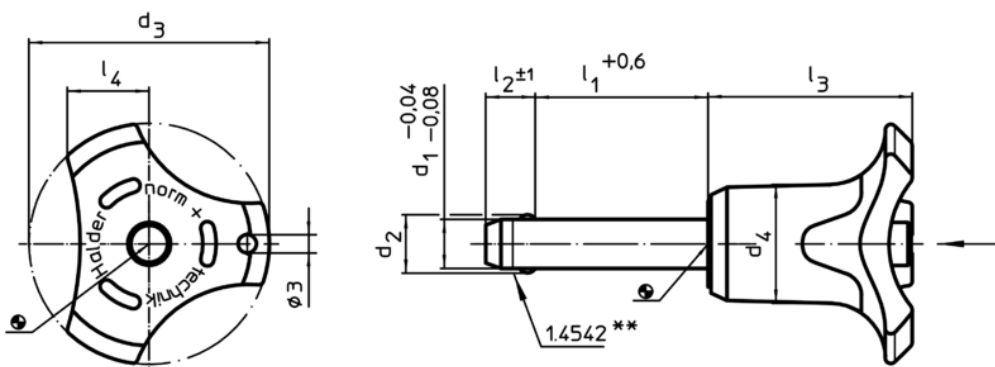

** Types from stainless steel 1.4542 with marking.

Order information

Dimensions									Location hole H11 [mm]	Shearing resistance, double ¹⁾ min. [kN]	 min. max. [°C]		 [g]	Art. No.
d ₁ -0,04 -0,08	l ₁ +0,6	d ₂	d ₃	d ₄ [mm]	l ₂ ±1	l ₃	l ₄							
black														
5	50	5,5	33,2	14,5	6	26,7	10,8	5	24	-30	80	23	22380.0808	

¹⁾ Shearing resistance similar to DIN 50141

Application example

