

Ball Lock Pins· self-locking, with elastic grip

22380.0729



Product Description

For quick fastening, locking, adjusting, changing and securing. Various applications in different sectors, e.g. sports, leisure, medical healing and remedial instruments and apparatuses, machine construction and engineering etc. Quickly and easily unlockable for frequently repeated connections.

All versions are corrosion resistant. When using stainless steel 1.4542: high-strength, hardened, abrasion resistant pin with high load capacity.

Elastic and ergonomic grip with integrated reset (locking). New, modern, patented design.

Material

Pin part

- Stainless steel 1.4542, precipitation-hardened

Handle

- Thermoplastic (PBT/TPE), grey / orange

Operation

The balls are unlocked by pressing the knob.

Characteristic

Types from stainless steel 1.4542 with marking below the balls.

More information

Notes

Special types on request.

Accessories

Can easily be fitted with retaining cable EH 22400.

Further products

- Locating Bushings, for ball lock pins and socket pins
- Locating Bushings, with flange, for ball lock pins and socket pins
- Retaining Cables
- Positioning Bushings, with collar
- Positioning Bushings, without collar

Drawing

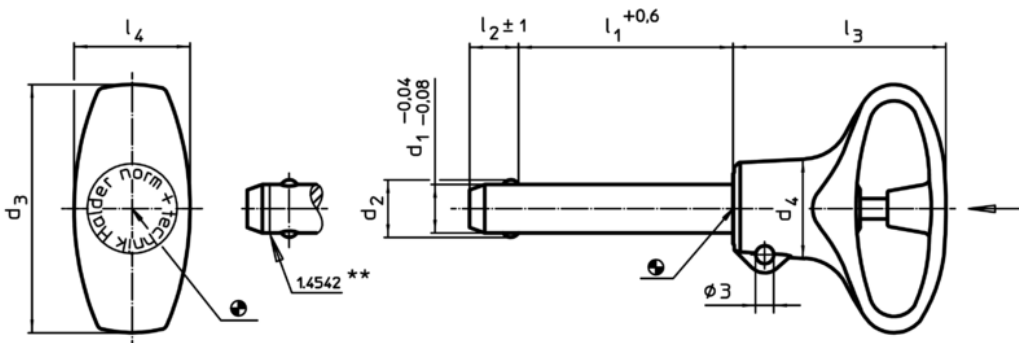

** Types from stainless steel 1.4542 with marking.

Order information

Dimensions								Location hole	Temperature		Weight	Shearing resistance, double ¹⁾ min.	Art. No.	
d ₁	l ₁	d ₂	d ₃	d ₄	l ₂	l ₃	l ₄	H11	min.	max.	[g]	[kN]		
[mm]								[mm]	[°C]					
-0,04 -0,08	+0,6				±1									
Stainless steel														
6	45	7	36	12,7	7	31	15,9	6	-30	80	18	35	22380.0729	

¹⁾ Shearing resistance similar to DIN 50141

Application example

