

Ball Lock Pins· self-locking, with adjustable clamping span

22380.0603



Product Description

Used for mounting or clamping workpieces, remove remaining play or slack via variable locknuts. All versions are corrosion resistant. When using stainless steel 1.4542: high-strength, hardened, abrasion resistant pin with high load capacity.

Material

Pin part

- Stainless steel 1.4542, precipitation-hardened

Lock nut

- Thermoplastic, black

Spring

- Stainless steel

Adjusting nut

- Thermoplastic, silver

Operation

The balls are unlocked by pressing the knob.

Characteristic

Types from stainless steel 1.4542 with marking below the balls.

More information

Notes

Special types on request.

Accessories

Can easily be fitted with retaining cable EH 22400.

Further products

- Locating Bushings, for ball lock pins and socket pins
- Locating Bushings, with flange, for ball lock pins and socket pins
- Retaining Cables
- Positioning Bushings, with collar
- Positioning Bushings, without collar

Drawing

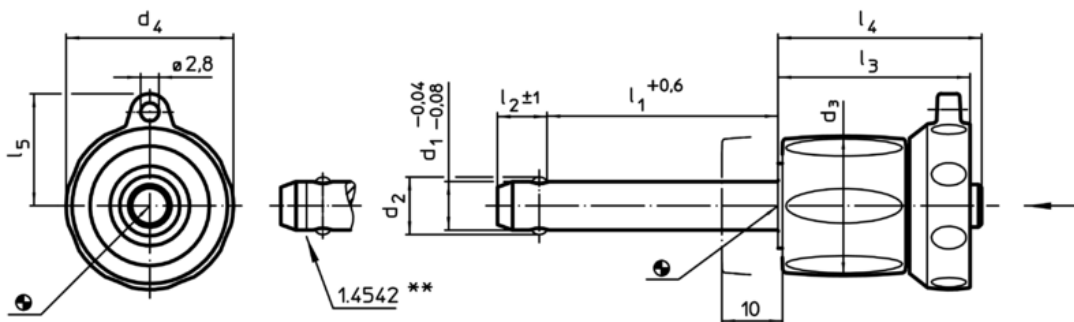

** Types from stainless steel 1.4542 with marking.

Order information

Dimensions									Location hole	Temperature		Weight	Shearing resistance, double ¹⁾	Art. No.
d ₁	l ₁	d ₂	d ₃	d ₄	l ₂	l ₃	l ₄	l ₅	H11	min.	max.	[g]	[kN]	
[mm]									[mm]	[°C]				
-0,04 -0,08	+0,6				±1									
Stainless steel														
6	5 – 15	7	17,6	23,6	7	25,7	26,2	15,9	6	-30	80	26	35	22380.0603

¹⁾ Shearing resistance similar to DIN 50141

Application example

