

## Ball Lock Pins· self-locking, with combination handle

22370.0243



### Product Description

For quick fastening, locking, adjusting, changing and securing. Quickly and easily unlockable for frequently repeated connections.  
All versions are corrosion resistant.  
Ergonomic grip, different colour combinations available. The grip design provides protection of unintentional unlocking.

### Material

#### Pin part

- Stainless steel 1.4305

#### Handle

- Thermoplastic PA 6 grey / orange

#### Spring

- Stainless steel

### Operation

The balls are unlocked by pressing the knob.

### More information

### Notes

Special types on request.

### References

Stainless steel 1.4542, see EH 22380.

### Accessories

Can easily be fitted with retaining cable EH 22400.

### Further products

- Ball Lock Pins, self-locking, with combination handle, precipitation-hardened
- Locating Bushings, for ball lock pins and socket pins
- Locating Bushings, with flange, for ball lock pins and socket pins
- Retaining Cables
- Positioning Bushings, with collar
- Positioning Bushings, without collar

### Drawing

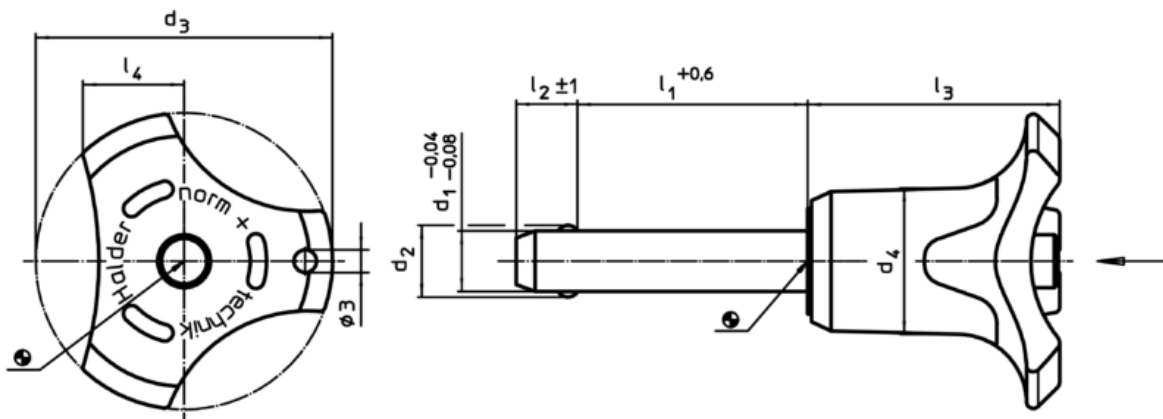

### Order information

Dimensions								Location hole H11	Shearing resistance, double <sup>1)</sup> min.	Temperature		Weight	Art. No.
d <sub>1</sub>	l <sub>1</sub>	d <sub>2</sub>	d <sub>3</sub>	d <sub>4</sub>	l <sub>2</sub>	l <sub>3</sub>	l <sub>4</sub>			min.	max.		
-0,04 -0,08	+0,6				±1			[mm]	[mm]	[kN]	[°C]	[g]	
<b>orange</b>													
16	150	19	47,6	25,2	14	39,7	16,7	16	155	-30	80	328	22370.0243

<sup>1)</sup> Shearing resistance similar to DIN 50141

Application example

