

Ball Lock Pins· self-locking, with combination handle

22370.0239



Product Description

For quick fastening, locking, adjusting, changing and securing. Quickly and easily unlockable for frequently repeated connections.
All versions are corrosion resistant.
Ergonomic grip, different colour combinations available. The grip design provides protection of unintentional unlocking.

Material

Pin part

- Stainless steel 1.4305

Handle

- Thermoplastic PA 6 grey / orange

Spring

- Stainless steel

Operation

The balls are unlocked by pressing the knob.

More information

Notes

Special types on request.

References

Stainless steel 1.4542, see EH 22380.

Accessories

Can easily be fitted with retaining cable EH 22400.

Further products

- Ball Lock Pins, self-locking, with combination handle, precipitation-hardened
- Locating Bushings, for ball lock pins and socket pins
- Locating Bushings, with flange, for ball lock pins and socket pins
- Retaining Cables
- Positioning Bushings, with collar
- Positioning Bushings, without collar

Drawing

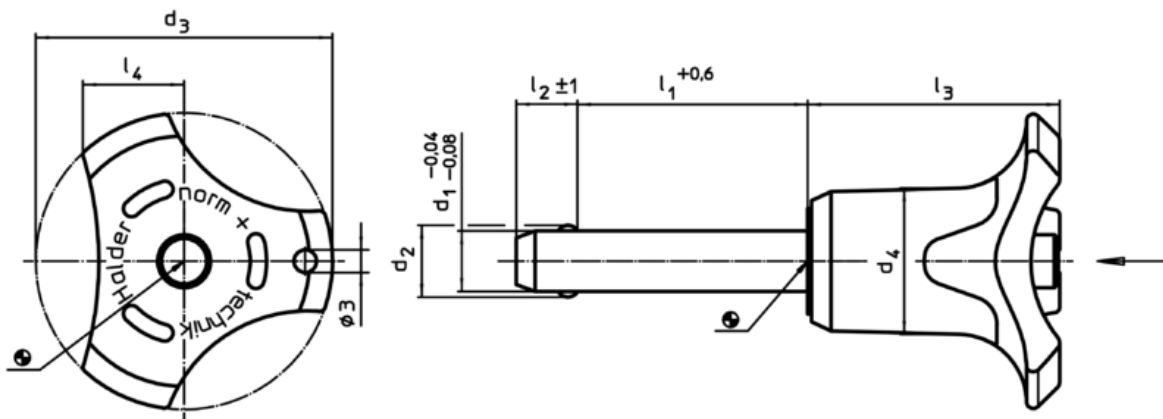

Order information

Dimensions								Location hole H11	Shearing resistance, double ¹⁾ min.	Temperature		Weight [g]	Art. No.
d ₁	l ₁	d ₂	d ₃	d ₄	l ₂	l ₃	l ₄			min.	max.		
-0,04 -0,08	+0,6				±1			[mm]	[kN]	[°C]			
orange													
16	110	19	47,6	25,2	14	39,7	16,7	16	155	-30	80	266	22370.0239

¹⁾ Shearing resistance similar to DIN 50141

Application example

