

Lifting Pins• self-locking, stainless steel

22350.0751



Product Description

Heavy-duty lifting element for quick and easy use, with moveable shackle and locking stud to provide protection against unintentional unlocking. Special lifting devices e.g. threads for ring bolts, are no longer required on the workpiece. Corrosion and weathering resistant, thus also suitable for outdoor application. Very solid, precipitation-hardened pin with an extreme load capacity.

Material

Pin part

- Stainless steel 1.4542, precipitation-hardened

Press button

- Aluminium, red anodised

Shackle

- Stainless steel 1.4571

Spring

- Stainless steel

Assembly

Simple H11 boreholes are sufficient. Each lifting pin contains an instruction manual with an EC Declaration of Conformity.

Operation

The balls are unlocked by pressing the knob.

More information

Accessories

Suitable locating bushings 22350.0900 - .0956 for $d_1 = 8, 10, 12, 16$ and 20 can be supplied as an accessory.

Further products

- Lifting Pins, self-locking
- Locating Bushings, for lifting pins
- Locating Bushings, plain, for lifting pins
- Locating bushing with seal, plain, for lifting pins

Drawing

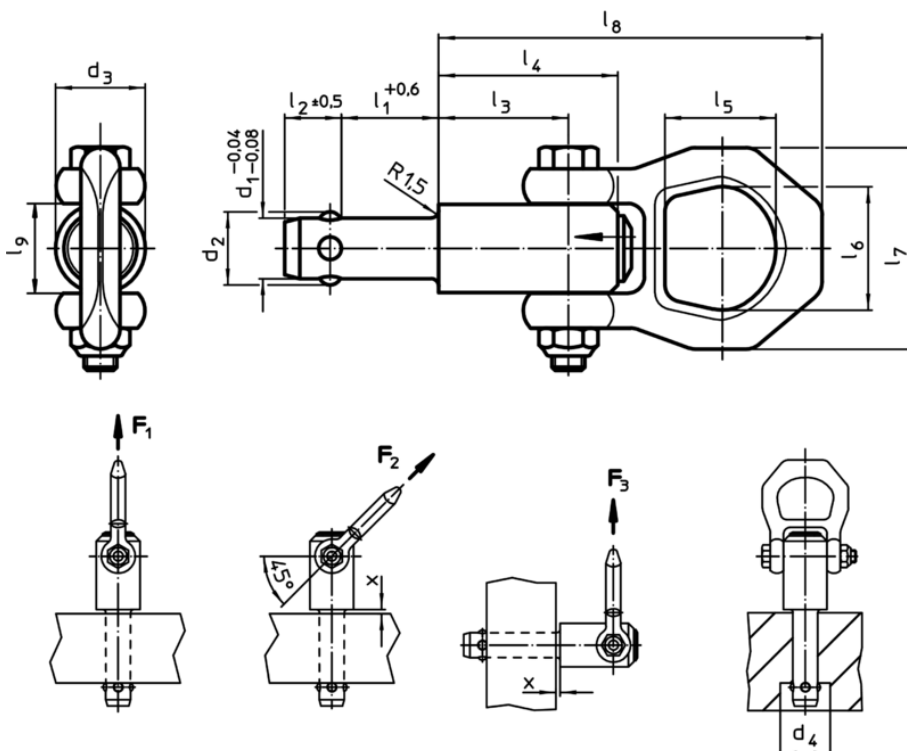

Order information

Dimensions													Carrying force ¹⁾			x		Location hole	max.		Art. No.
d ₁	l ₁	d ₂	d ₃	d ₄	l ₂	l ₃	l ₄	l ₅	l ₆	l ₇	l ₈	l ₉	F ₁	F ₂	F ₃	¹⁾ min.	max.	H11	max.		
[mm]													[kN]			[mm]		[mm]	[°C]	[g]	
13,8	25	16,2	21,5	16,7	13	25,7	36	27	30	49	87,5	21,5	3,8	3,5	2,8	1,5	15	13,8	250	255	22350.0751

¹⁾ for a 5-fold safety against breakage

Application example

