

Ball Lock Pins· self-locking, with button handle

22350.0225



Product Description

For quick fastening, locking, adjusting, changing and securing. Quickly and easily unlockable for frequently repeated connections.

All versions are corrosion resistant. When using stainless steel 1.4542: high-strength, hardened, abrasion resistant pin with high load capacity.

Compact design with button handle.

Material

Pin part

- Stainless steel 1.4542, precipitation-hardened

Handle

- Aluminium, black similar to RAL 9005

Press button

- Stainless steel, black

Spring

- Stainless steel

Operation

The balls are unlocked by pressing the knob.

Characteristic

Types from stainless steel 1.4542 with marking below the balls.

More information

Notes

Special types on request.

Accessories

Can easily be fitted with retaining cable EH 22400.

Further products

- Locating Bushings, for ball lock pins and socket pins
- Locating Bushings, with flange, for ball lock pins and socket pins
- Retaining Cables
- Positioning Bushings, with collar
- Positioning Bushings, without collar
- Ball Lock Pins with Button Handle, single acting - according to NASM / MS 17984

Drawing

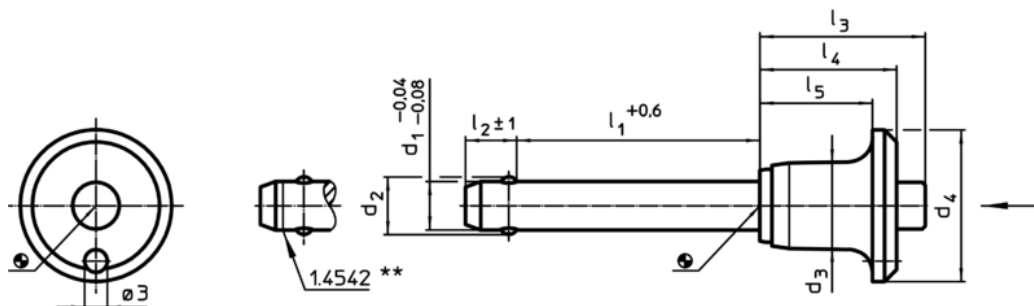

** Types from stainless steel 1.4542 with marking.

Order information

Dimensions									Location hole	min. max.		Shearing resistance, double ¹⁾ min.	Art. No.	
d ₁	l ₁	d ₂	d ₃	d ₄	l ₂ ±1	l ₃	l ₄	l ₅	H11	[°C]	[g]			[kN]
-0,04 -0,08	+0,6													
[mm]														
Stainless steel														
6	25	7	11,3	20	7	20,7	17,6	14,6	6	-30	150	16	35	22350.0225

¹⁾ Shearing resistance similar to DIN 50141

Application example

