

## Ball Lock Pins· self-locking, with L-handle

22340.0205



### Product Description

For quick fastening, locking, adjusting, changing and securing. Quickly and easily unlockable for frequently repeated connections.

All versions are corrosion resistant. When using stainless steel 1.4542: high-strength, hardened, abrasion resistant pin with high load capacity.

Version with ergonomic grip.

### Material

#### Pin part

- Stainless steel 1.4305

#### Handle

- Aluminium, black similar to RAL 9005

#### Press button

- Stainless steel, black

#### Spring

- Stainless steel

### Operation

The balls are unlocked by pressing the knob.

### Characteristic

Types from stainless steel 1.4542 with marking below the balls.

### More information

### Notes

Special types on request.

- This product is also available in INCH dimensions.

### Accessories

Can easily be fitted with retaining cable EH 22400.

### Further products

- Locating Bushings, for ball lock pins and socket pins
- Locating Bushings, with flange, for ball lock pins and socket pins
- Retaining Cables
- Positioning Bushings, with collar
- Positioning Bushings, without collar
- Ball Lock Pins with L-handle, single acting - according to NASM / MS 17986

### Drawing

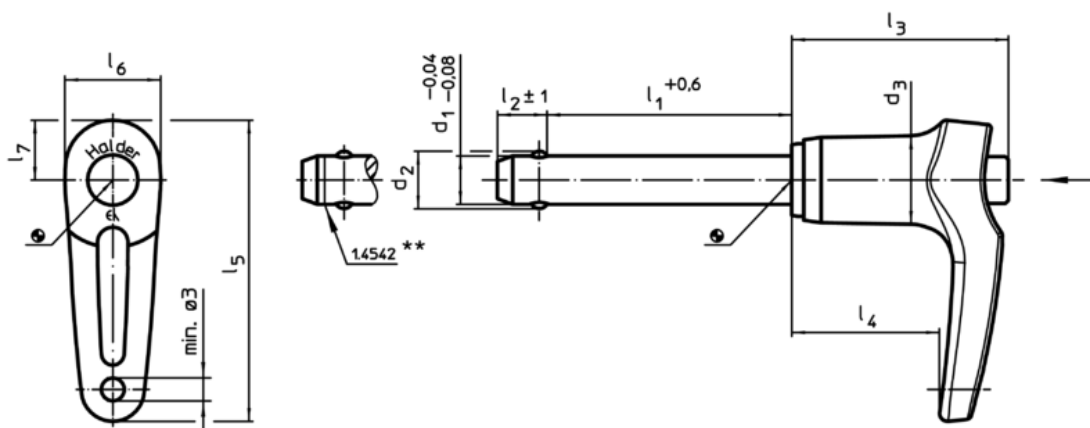

\*\* Types from stainless steel 1.4542 with marking.

Order information

Dimensions										Location hole	Temperature		Weight	Shearing resistance, double <sup>1)</sup> min.	Art. No.
d <sub>1</sub>	l <sub>1</sub>	d <sub>2</sub>	d <sub>3</sub>	l <sub>2</sub>	l <sub>3</sub>	l <sub>4</sub>	l <sub>5</sub>	l <sub>6</sub>	l <sub>7</sub>	H11	min.	max.	[g]	[kN]	
[mm]										[mm]	[°C]				
Stainless steel															
25	100	31	30,4	22	54,8	34,2	83,9	33,3	20,1	25	-30	150	639	386	22340.0205

<sup>1)</sup> Shearing resistance similar to DIN 50141

Application example

