

Ball Lock Pins· self-locking, with L-handle

22340.0163



Product Description

For quick fastening, locking, adjusting, changing and securing. Quickly and easily unlockable for frequently repeated connections.

All versions are corrosion resistant. When using stainless steel 1.4542: high-strength, hardened, abrasion resistant pin with high load capacity.

Version with ergonomic grip.

Material

Pin part

- Stainless steel 1.4305

Handle

- Aluminium, black similar to RAL 9005

Press button

- Stainless steel, black

Spring

- Stainless steel

Operation

The balls are unlocked by pressing the knob.

Characteristic

Types from stainless steel 1.4542 with marking below the balls.

More information

Notes

Special types on request.

- This product is also available in INCH dimensions.

Accessories

Can easily be fitted with retaining cable EH 22400.

Further products

- Locating Bushings, for ball lock pins and socket pins
- Locating Bushings, with flange, for ball lock pins and socket pins
- Retaining Cables
- Positioning Bushings, with collar
- Positioning Bushings, without collar
- Ball Lock Pins with L-handle, single acting - according to NASM / MS 17986

Drawing

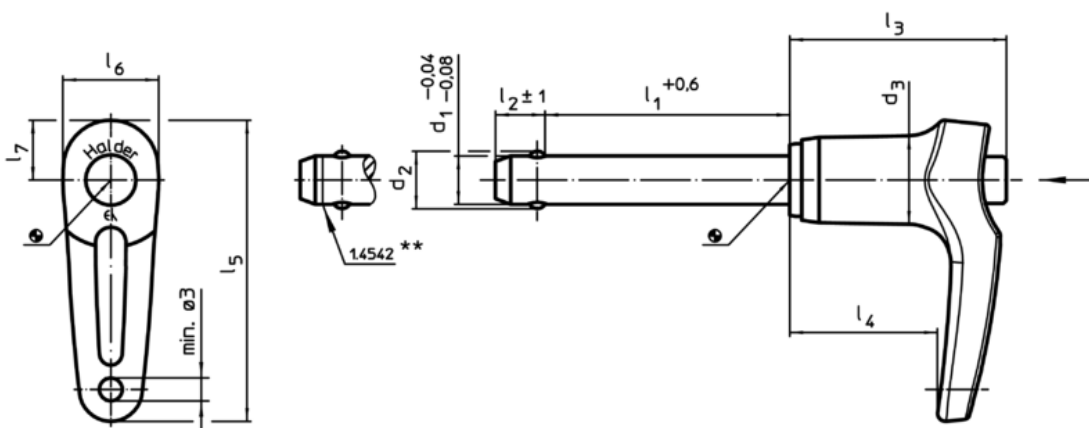

** Types from stainless steel 1.4542 with marking.

Order information

Dimensions										Location hole	Temperature		Weight	Shearing resistance, double ¹⁾ min.	Art. No.
d ₁	l ₁	d ₂	d ₃	l ₂	l ₃	l ₄	l ₅	l ₆	l ₇	H11	min.	max.	[g]	[kN]	
[mm]										[mm]	[°C]				
-0,04	+0,6			±1											
-0,08															
Stainless steel															
12	120	14,5	18,2	10,6	35,1	22,7	57,1	20,2	12,6	12	-30	150	154	87	22340.0163

¹⁾ Shearing resistance similar to DIN 50141

Application example

