

Ball Lock Pins· self-locking, with L-handle

22340.0117



Product Description

For quick fastening, locking, adjusting, changing and securing. Quickly and easily unlockable for frequently repeated connections.

All versions are corrosion resistant. When using stainless steel 1.4542: high-strength, hardened, abrasion resistant pin with high load capacity.

Version with ergonomic grip.

Material

Pin part

- Stainless steel 1.4305

Handle

- Aluminium, black similar to RAL 9005

Press button

- Stainless steel, black

Spring

- Stainless steel

Operation

The balls are unlocked by pressing the knob.

Characteristic

Types from stainless steel 1.4542 with marking below the balls.

More information

Notes

Special types on request.

- This product is also available in INCH dimensions.

Accessories

Can easily be fitted with retaining cable EH 22400.

Further products

- Locating Bushings, for ball lock pins and socket pins
- Locating Bushings, with flange, for ball lock pins and socket pins
- Retaining Cables
- Positioning Bushings, with collar
- Positioning Bushings, without collar
- Ball Lock Pins with L-handle, single acting - according to NASM / MS 17986

Drawing

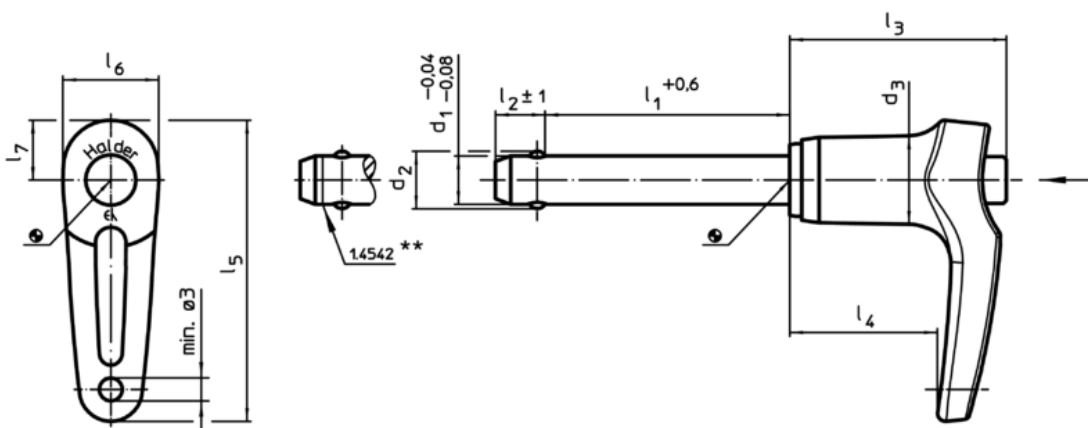

** Types from stainless steel 1.4542 with marking.

Order information

Dimensions										Location hole H11	min. max.		[g]	Shearing resistance, double ¹⁾ min. [kN]	Art. No.	
d ₁	l ₁	d ₂	d ₃	l ₂	l ₃	l ₄	l ₅	l ₆	l ₇	[mm]	min.	max.				[°C]
-0,04 -0,08	+0,6			±1												
[mm]																
Stainless steel																
5	35	5,5	11,8	6	31,6	21,9	43,8	12,6	8,5	5	-30	150	18	14	22340.0117	

¹⁾ Shearing resistance similar to DIN 50141

Application example

