

C-Washers · DIN 6372
22290.0030

Product Description



Material

- Heat-treated steel, tempered, blackened

Drawing

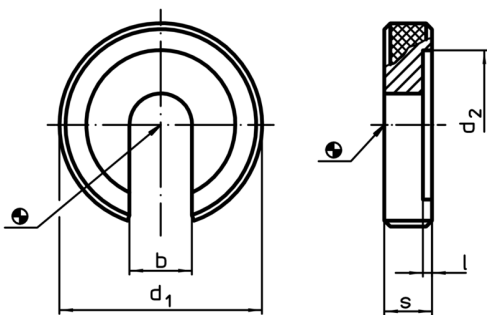

Order information

Nominal size [mm]	Dimensions					[g]	Art. No.
	b	d ₁	d ₂ [mm]	l	s		
30	31	90	65	2	18	610	22290.0030

Application example

