

Captive C-Washers· DIN 6371 with countersunk screw DIN 923

22280.0024



Product Description

Material

Countersunk screw

- Steel, blackened, quality 5.8

Captive C-Washer

- Heat-treated steel, tempered, blackened

Assembly

The captive C-washers can be installed using the included bolt. You can select either clockwise or anti-clockwise rotation.

Drawing

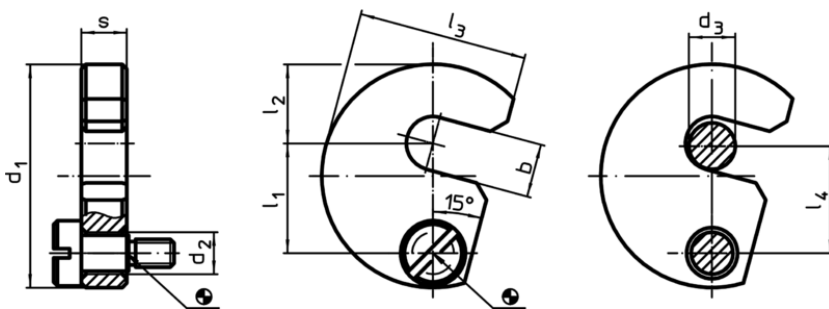

Order information

Nominal size d_3 [mm]	b	d_1	d_2	Dimensions					s -0,2	Suitable screw [mm]	 [g]	Art. No.
				l_1	l_2	l_3	l_4	[mm]				
24	25,5	82	11	40,6	32	62	40	15,8	M8 x 16	430	22280.0024	

Application example

