

Index Plungers compact with hexagon collar

22110.0109



Product Description

Index plungers are used for indexing bores.
Types with / without lock have the same building height.
Due to a thread recess the index plungers can be completely screwed in.

Material

Body

- Steel, blackened

Locking pin

- Steel, hardened

Knob

- Thermoplastic PA 6, black, dull

Assembly

The screw length can be adapted by distance collars for index plungers (EH 22120.).

More information

Notes

Knob not removable.
Lock nuts have to be purchased separately.

Further products

- Mounting Blocks, for index plungers and index bolts zinc die-cast
- Locating Bushings, for index bolts and index plungers
- Distance Collars, for index plungers

Drawing

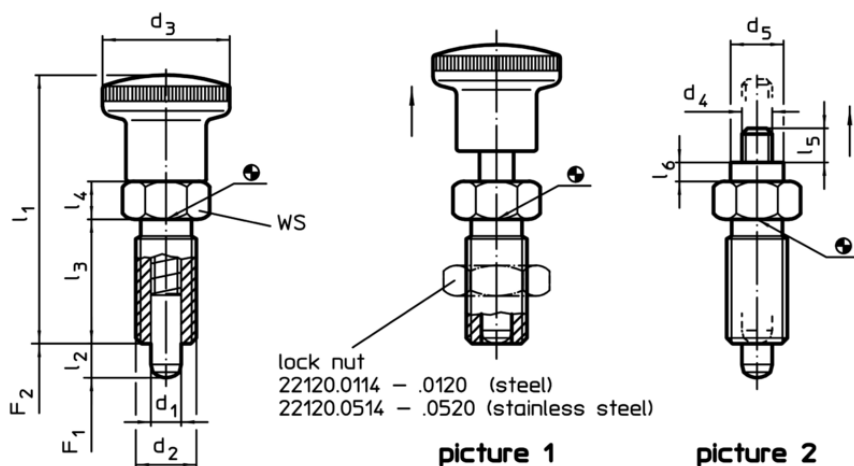



Order information

Dimensions							WS	Spring load ¹⁾		Temperature		Weight	Art. No.
d ₁	l ₂ min.	d ₂	d ₃	l ₁	l ₃	l ₄		F ₁ ~	F ₂ ~	min.	max.		
[mm]							[mm]	[N]		[°C]		[g]	
with knob – picture 1, Steel													
6	6	M12 x 1,5	23	48	22	6	14	6,5	19	-30	80	29	22110.0109

¹⁾ statistical average value

Accessories

	Dimensions d_2 [mm]	WS [mm]	 [g]	Art. No.
lock nuts ISO 8675 (DIN 439) for the following sizes, Steel				
	M12 x 1,5	18	7,4	22120.0116

Application example

