

Spring Plungers· long

22070.0532

Product Description

To be used for ejecting, as a detent, for applying pressure or as a shock element.



Material

Pin

- Steel, case-hardened, blackened

Body

- Free cutting steel, blackened

Spring

- Stainless steel

Assembly

Spring plungers can be mounted and removed by means of the slot or internal hexagon. Please use a special assembly tool for mounting with a slot (pin side).

Characteristic

Reinforced spring load: marked with two lines

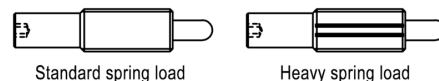

More information

Notes

Special types on request.
Spring range and forces are precisely tested.

References

Thread lock on request, please refer to appendix - Technical Data -

Drawing

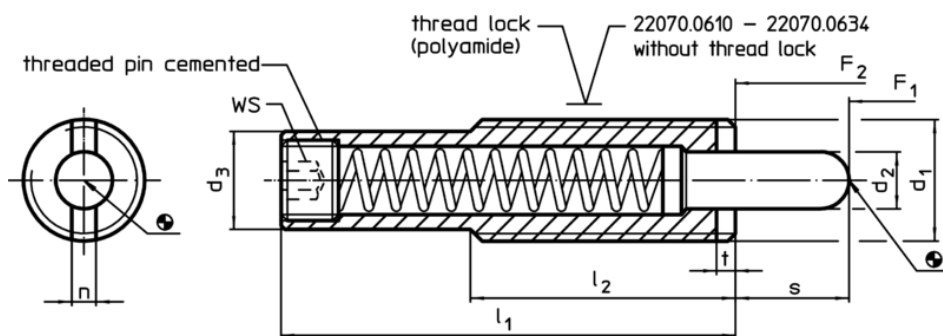

Order information

Dimensions							Stroke	WS	Spring load ¹⁾		Temperature		Weight	Art. No.
d ₁	d ₂	d ₃	l ₁	l ₂	n	t	s		F ₁	F ₂	min.	max.	[g]	
[mm]							[mm]	[mm]	[N]	[N]	[°C]			
body from free cutting steel, heavy spring load														
M16	8	13,4	58	35	3,2	3	10	6	14	84	-30	90	54	22070.0532

¹⁾ statistical average value

Accessories

Dimensions	Weight	Art. No.
d ₁	[g]	
[mm]		
Assembly tool for mounting via slot (pin sided)		
M16	110	22070.0834

Application example

