

Ball Lock

**Punches
Die Buttons
Pilots
Retainers**

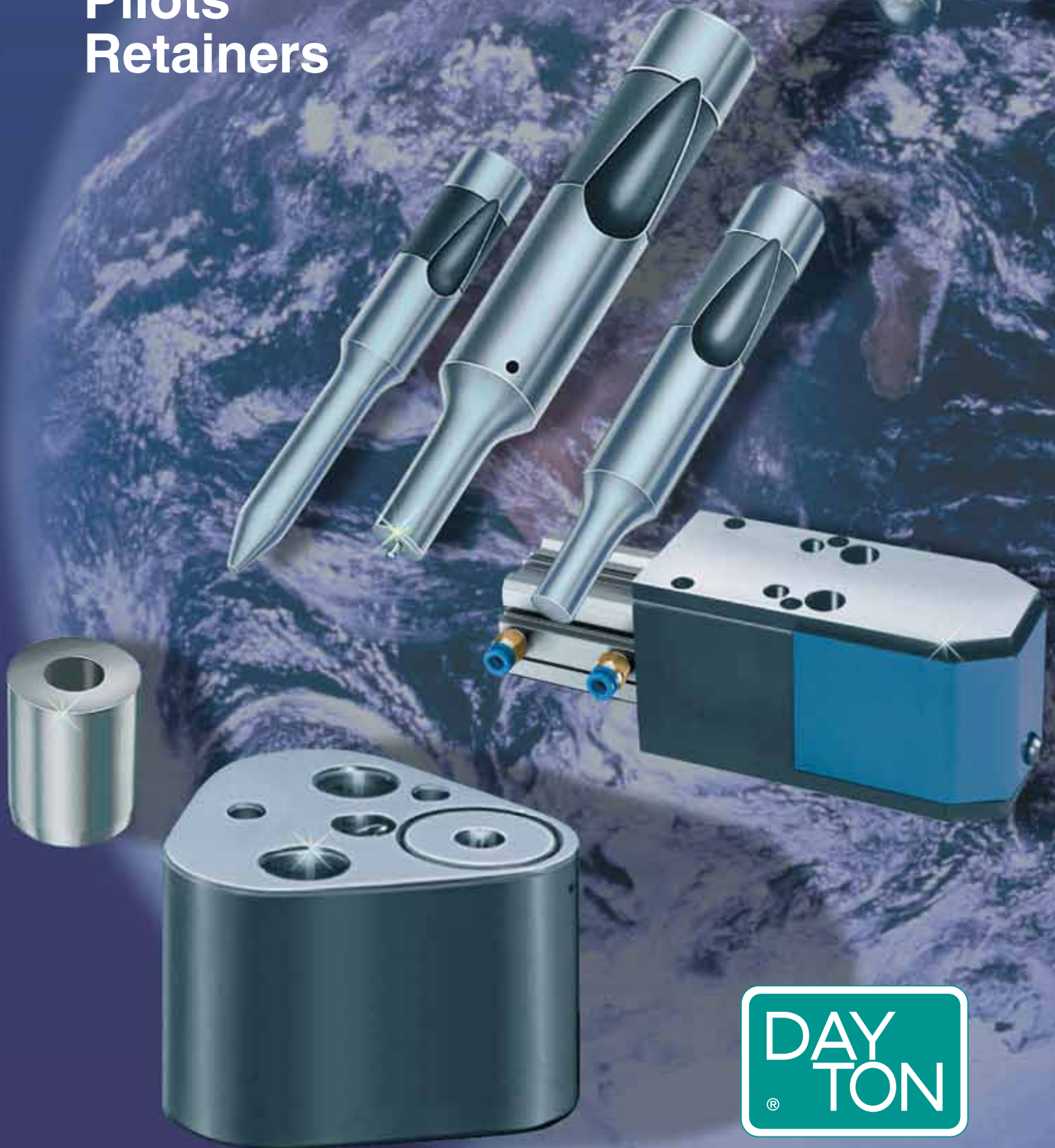

Visit us at www.daytonprogress.com

Ball Lock Products

Quick Change Punches and Retainers

Jektole® Punches and Clearances

Jektole®, Dayton's slug ejection punch permits doubling punch to die button clearance; produces up to three times the number of hits between sharpenings and reduces burr height.



Ball Lock Retainers for Single Punches

True Position® retainers allow easy replacement of worn punches, drastically reducing downtime. It has been adopted as the world-standard by many automobile manufacturers. They are CNC compatible and require no re-doweling when replacing. The precision ground ball hole assures repetitive alignment of shaped punches.



Change retainers allow multiple hole patterns to be punched without the need to change dies. Different parts such as right and left hand can be run in one die. An air cylinder retracts the punch when a hole is not needed.



Ultra-Compact retainers for round punches and pilots use less space and a single dowel for location.



Multiple Punch Retainers

When a cluster of holes is in an extremely tight area where single retainers will not fit, standard retainers with multiple holes are the answer. Dayton's **Multi-Position** retainers provide a simple low cost solution to multiple holes in a small area. They eliminate the need for special details, cutting both design and build time.



Other Products That Complement Retainers

Urethane strippers that fit tightly over punches might be the answer to some of the low production jobs. Urethane can eliminate the costly stripper plate and provides a benefit over the bridge stripper normally used in low budget jobs. They hold the stock flat, unlike a bridge stripper, assuring the least amount of stripping pressure and resulting wear on punches.



Punch Pullers



Ball lock punches can sometimes be very difficult to remove from retainers. Many tools have been used by maintenance people but none are as simple or as effective as Dayton **Punch Pullers**. The task of removal is simple. Slide the Punch Puller over the punch shank, rotate the built-in wrench until it is tight, release the ball in the retainer and pull down. No more struggling with home-made tools and best of all no more busted knuckles.

Wear Resistant Coatings and Surface Treatments

Some catalog products can be coated to increase hardness, reduce galling, and improve wear and/or corrosion resistance. These coatings and treatments are available for M2 and PS4 material. See page 33 for a complete list.

Shear Angles

Shear Angles can be applied to all punch points. These angles are used primarily to reduce slug pulling. Single and Double Shears can be used to reduce the punching force as well as minimize slug pulling. These alterations are prepriced and do not add to the standard delivery of the product. See page 33.

Retainer Accessories

All Dayton retainers come with all the necessary hardware for precise mounting. If replacement parts are needed they can be found in the **Retainer Accessories** section of this catalog. It is always a good idea to keep spares of anything that is vital to maintaining production. You don't want an inexpensive item holding up production.



® Jektole, DayTride, DAYTiN, True Position, True Position Shape and the True Position Backing Plug Design are registered trademarks of Dayton Progress Corporation.

™ EZ Fit, DayTAN, DayKool, ZertonPlus, Multi-Position and all Trilateral Designators are trademarks of Dayton Progress Corporation.

© 2000 Dayton Progress Corporation
All Rights Reserved

Several products in this catalog conform to standards established by the North American Automotive Metric Standards (NAAMS™) for Forming and Stamping. Those products are appropriately identified on the page that they appear as well as in the table of contents on the next page.

NAAMS™ is a trademark of Auto/Steel Partnership

Table of Contents

Punches Heavy Duty

Standard Shapes

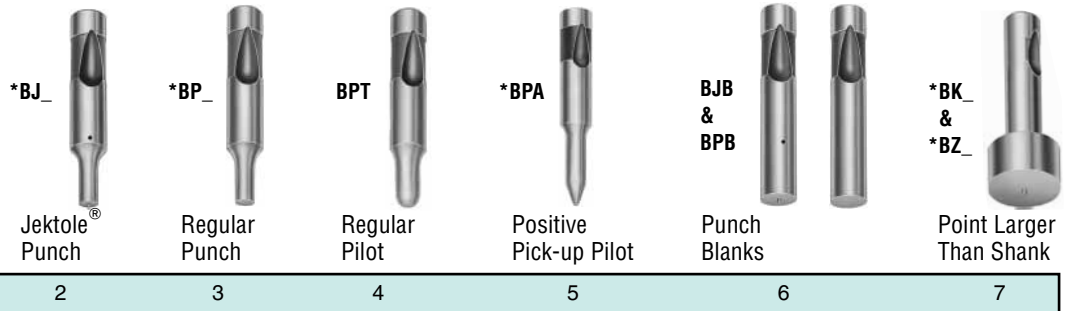
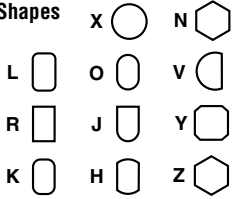

2 3 4 5 6 7

Punches Light Duty

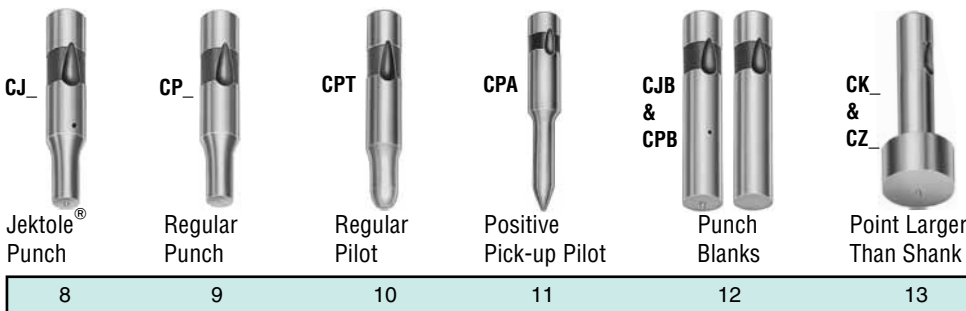

8 9 10 11 12 13

Die Buttons

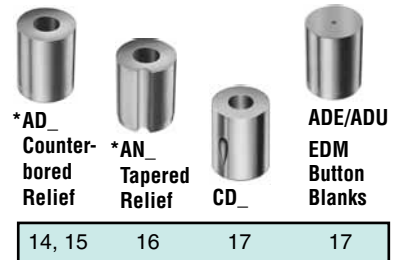

14, 15 16 17 17

Retainers

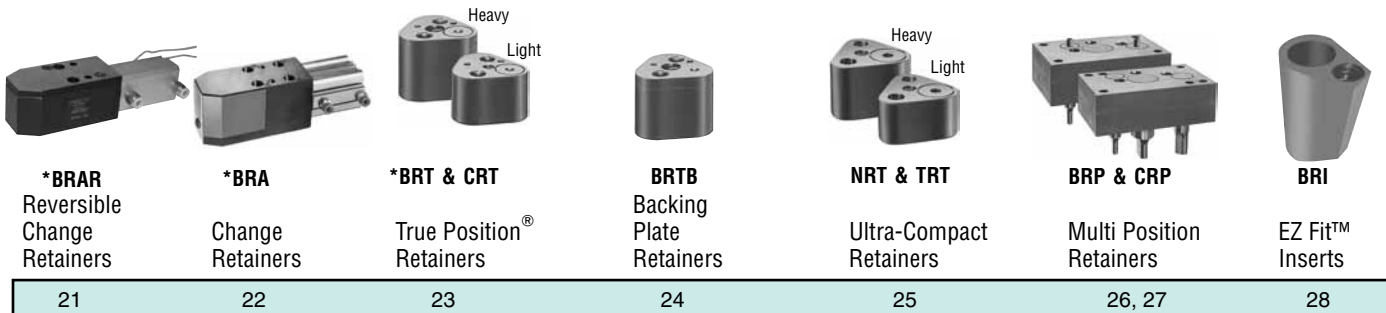

21 22 23 24 25 26, 27 28

Miscellaneous

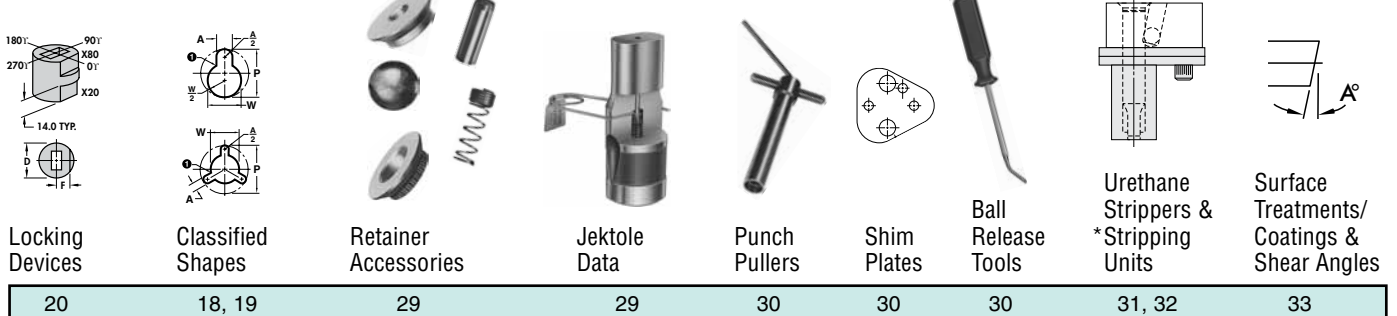

20 18, 19 29 29 30 30 30 31, 32 33

Catalog Ordering System

The Catalog Designation completely defines the product, including shape, dimensions, tolerances and concentricity.

Example:

Line Product Shape

B for Heavy Duty
P for Punch (Regular)
R for Rectangle

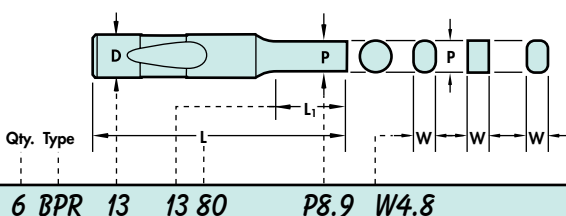

BPR 13 13 80
Shank Dia. D
Point Length L₁
Overall Length L
Point or Hole Size

6 BPR 13 13 80 P8.9 W4.8 BPR™ 13 13 80 P8.9 W4.8

*NAAMS™ Standard

Catalog Number

Dimensions as Specified

Heavy Duty Jektole® Punches

Steel:	HRC
M2, PS4	60-63

Type
BJ_

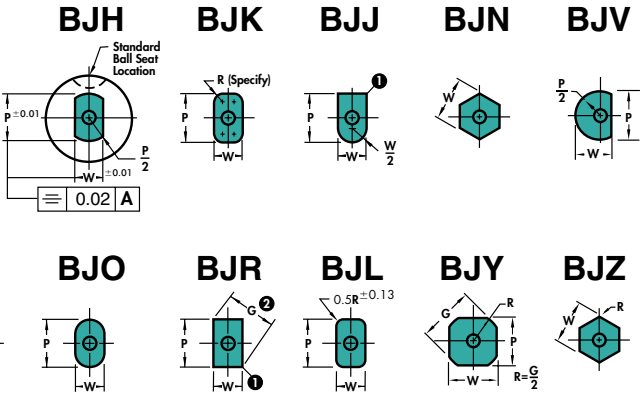
BJH **BJK** **BJJ** **BJN** **BJV**

BJX **BJO** **BJR** **BJL** **BJY** **BJZ**

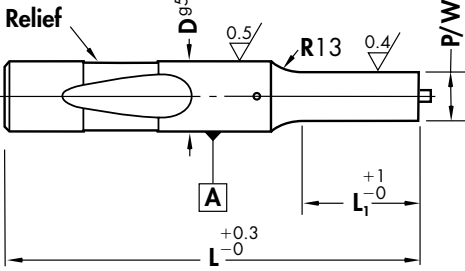

No side hole D32, 40

① Sharp corners are typical. To assure proper clearance, Dayton will provide standard broken corners if die button is ordered with punch to eliminate interference with die button fillet when total clearance is 0.08 or less.

② Check your P&W dimensions to be sure the diagonal G does not exceed the max. shown. .

$G = \sqrt{P^2 + W^2}$

D	Point Length L ₁			Type & D	Round Range P	Type & D	Shape Min. W	Max. P/G	L						Jektole Pin	
	Std.	Alt.	Alt.						63	71	80	90	100	110		125
10	19	10*	—	BJX10	2.10- 9.97	BJ_10	2.10- 9.97									J4M†
13	19	13	25	BJX13	5.00-12.97	BJ_13	4.50-12.97									J6M
16	19	13	25	BJX16	8.00-15.97	BJ_16	6.00-15.97									J6M
20	19	13	25	BJX20	12.00-19.97	BJ_20	8.00-19.97									J9M
25	19	13	25	BJX25	16.00-24.97	BJ_25	10.00-24.97									J9M
32	19	13	25	BJX32	24.00-31.97	BJ_32	12.50-31.97									J12M
40	25	19	30	BJX40	30.00-39.97	BJ_40	14.00-39.97									J12M

*Min P or W = 1.60 when L₁ = 10 *Min P or W and smaller may result in less than 25 Alt. L₁ ■ L₁ 25 not available. †J2 (P < 3.0)

Standard Alterations for BJ and BP Punches

Standard Alterations are beyond those sizes listed above and can be manufactured for a slight additional charge.

XBB adds 3 days to delivery

L ₁ Max	XBR						XBB					
	13	19	25	30	35	40	13	19	25	30	35	40
D	Minimum P Rounds						Minimum W Shapes					
10	1.4	1.5	2.4	3.2	4.0	5.0	1.4	1.5	2.4	4.0	4.0	5.0
13	4.0	4.0	4.0	4.0	4.0	5.0	4.0	4.0	4.0	4.0	4.5	5.0
16	4.0	4.0	4.0	4.0	4.0	6.0	4.0	4.0	4.0	4.0	4.5	6.0
20	6.0	6.0	6.0	7.6	7.6	7.6	6.0	6.0	6.0	6.0	6.0	6.0
25	8.0	8.0	8.0	10.0	10.0	10.0	6.0	6.0	6.0	6.0	6.0	6.0
32	10.0	10.0	10.0	10.0	10.0	10.0	7.2	7.2	7.2	7.2	7.2	7.2
40	12.0	12.0	12.0	12.0	12.0	12.0	7.2	7.2	7.2	7.2	7.2	7.2

XP, XW P or W Dimensions Smaller than Standard

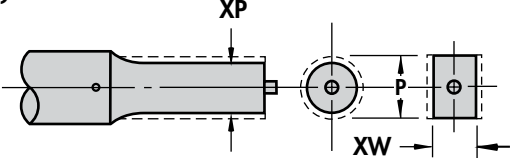

XBR Point Length Longer than Standard

Specify XBR or XBB and length (see chart at left)

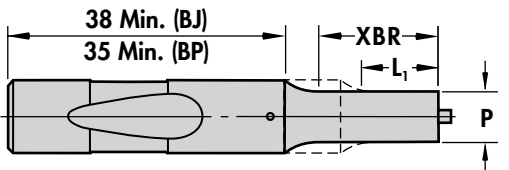

XL Overall Length Shortened

Stock removal from point end which shortens point length. To maintain point length specify XBR.

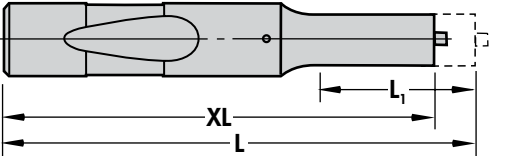

XLB Overall Length Shortened

L₁ length maintained. (See XBR for min. shank length)

Steel:	HRC
M2, PS4	60-63

Heavy Duty Regular Punches

Type
BP_

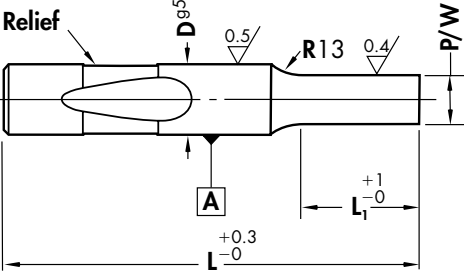
BPH

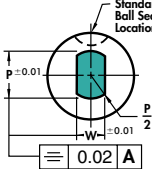

BPK

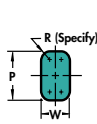

BPJ

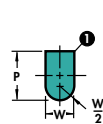

BPN

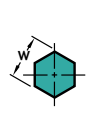

BPV

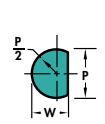

BPX

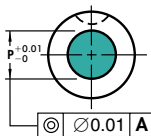

BPO

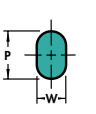

BPR

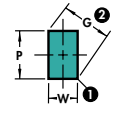

BPL

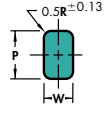

BPY

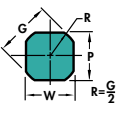

BPZ

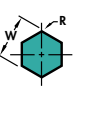

① Sharp corners are typical. To assure proper clearance, Dayton will provide standard broken corners if die button is ordered with punch to eliminate interference with die button fillet when total clearance is 0.08 or less.

② Check your P&W dimensions to be sure the diagonal G does not exceed the max. shown.

$G = \sqrt{P^2 + W^2}$

D	Point Length L ₁		Type & D	Round Range P	Type & D	Shape Min. W	Max. P/G	L							
	Std.	Alt.						Alt.	63	71	80	90	100	110	125
10	19	10*	—	BPX10	2.10- 9.97	BP_10	2.10- 9.97	•	•	•	•	•	•	•	•
13	19	13	25	BPX13	5.00-12.97	BP_13	4.50-12.97	•	•	•	•	•	•	•	•
16	19	13	25	BPX16	8.00-15.97	BP_16	6.00-15.97	•	•	•	•	•	•	•	•
20	19	13	25	BPX20	12.00-19.97	BP_20	8.00-19.97	•	•	•	•	•	•	•	•
25	19	13	25	BPX25	16.00-24.97	BP_25	10.00-24.97	•	•	•	•	•	•	•	•
32	19	13	25	BPX32	24.00-31.97	BP_32	12.50-31.97	•	•	•	•	•	•	•	•
40	25	19	30	BPX40	30.00-39.97	BP_40	14.00-39.97	•	•	•	•	•	•	•	•

*Min P or W = 1.60 when L₁ = 10

*Min P or W and smaller may result in less than 25 Alt. L₁

■ L₁ 25 not available.

See page 33 for coatings/treatments and shear angles.

XK No Side Hole
For air ejection.
No cost. Components not supplied.

XJ Smaller Jektole Components.
See page 29.

Standard Ball Seat Locations
Standard Ball Seat Location is at 90°. Alternate locations of 0°, 180°, or 270° can be specified at *no additional cost*.

Custom Ball Seat Locations
Custom Ball Seat Locations can be specified as BS and degrees counter-clockwise from 0°.

Double Ball Seat Locations
A second ball seat can be specified. Normally located 180° from the primary ball seat these are used to minimize sharpening of notching punches by rotating the punch 180°. Specify SB and degree desired. Can also be located 90° from primary ball seat. *Not recommended for shank diameters under 20.*

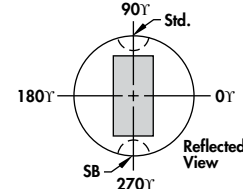
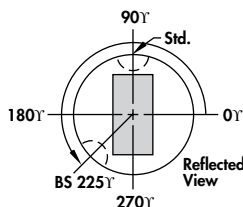

BJL & BPL Punches For Longer Life

Dayton's BJL & BPL punches with a constant corner radius of 0.5R puts the clearance where it's needed to prevent rapid wear and unacceptable burrs commonly generated with sharp corners. This reduces maintenance time and the risk of edge breaking during operation.

The "L" Long Life punch will reduce maintenance costs while increasing production runs by reducing corner wear.

How to Order:

Specify: Quantity
Type
Shank & Length Codes
P or P&W Dimensions
Standard Alterations

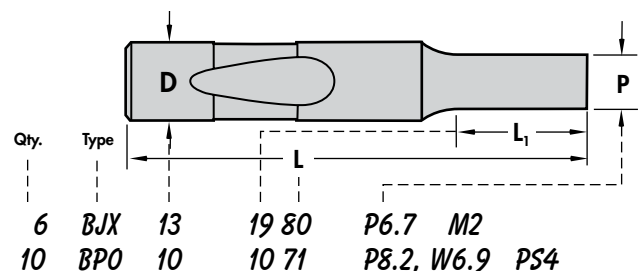

Heavy Duty Regular Pilots

Steel:	HRC
M2, PS4	60-63

Type
BPT

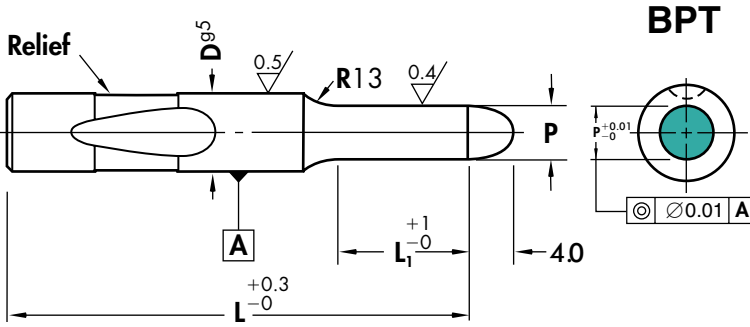

BPT

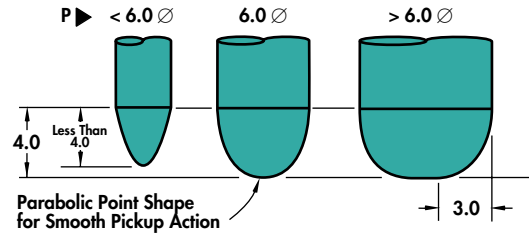

When P = D Shank tolerance applies to full length

D	Point Length L ₁			Type & D	Round Range P	L						
	Std.	Alt.	Alt.			65	73	82	92	102	112	127
10	21	12*	—	BPT10	2.05-10.00	•	•	•	•	•	•	
13	21	15	27	BPT13	4.95-13.00	•	•	•	•	•	•	•
16	21	15	27	BPT16	7.95-16.00	•	•	•	•	•	•	•
20	21	15	27	BPT20	11.95-20.00		•	•	•	•	•	•
25	21	15	27	BPT25	15.95-25.00		•	•	•	•	•	•
32	21	15	27	BPT32	23.95-32.00			•	•	•	•	•
40	27	21	32	BPT40	29.95-40.00				•	•	•	•

*Min P = 1.55 when L₁ = 12

■ L₁ 27 not available.

Standard Alterations for BPT and BPA Pilots

Standard Alterations are beyond those sizes listed above and can be manufactured for a slight additional charge.

XBB and X3B adds 3 days to delivery

L ₁ Max	BPA BPT	XBB and X3B adds 3 days to delivery								
		XBR			XBB			X3B		
D		13	19	25	30	35	40	50	60	70
		15	21	27	32	37	42	—	—	—
		Minimum P								
10		1.40	1.45	2.35	3.15	3.95	4.95	5.95	5.95	7.95
13		2.05	2.35	3.15	3.15	3.95	4.95	5.95	5.95	7.95
16		3.95	3.95	3.95	3.95	3.95	5.95	5.95	5.95	7.95
20		5.95	5.95	5.95	7.55	7.55	7.55	7.55	7.55	7.95
25		7.95	7.95	7.95	9.95	9.95	9.95	9.95	9.95	9.95
32		9.95	9.95	9.95	9.95	9.95	9.95	9.95	9.95	9.95
40		11.95	11.95	11.95	11.95	11.95	11.95	11.95	11.95	11.95

Shaded Area for BPA Only

Point Length Longer than Standard

Specify XBR, XBB, or X3B and length (see chart at left)

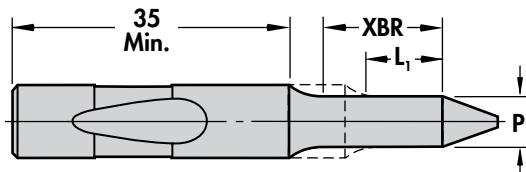

XP P Dimensions Smaller than Standard

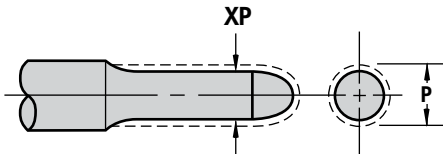

Steel:	HRC
M2, PS4	60-63

Heavy Duty Positive Pick-up Pilots

Order any length from 80 through 150mm

Type
BPA

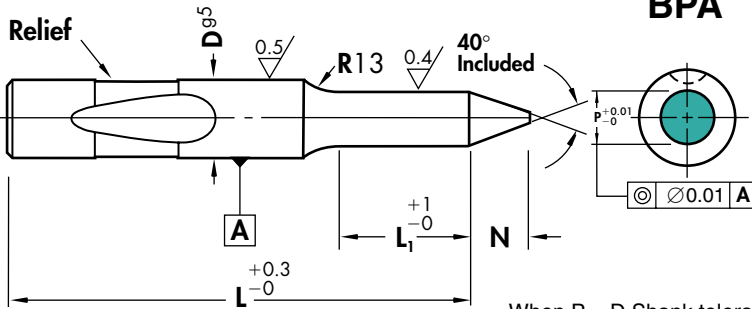

When P = D Shank tolerance applies to full length

Geometry provides smoother pick-up without the risk of distorting the hole.

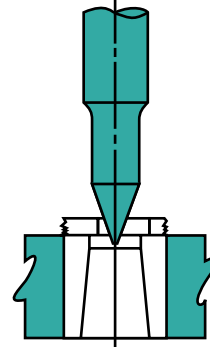

Greater Positioning moves the stock further than conventional pilots.

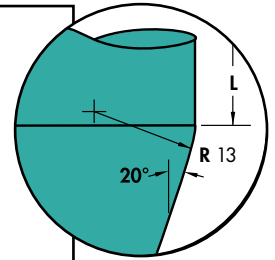

D	Point Length L ₁			Type & D	Round Range P	N	L								
	Std.	Alt.	Alt.				80	90	100	110	125	140	150		
10	19	32		BPA10	5.00-10.00	8	•	•	•	•					
13	19	32		BPA13	9.00-13.00	10	•	•	•		•	•			
16	25	38	L	BPA16	12.00-16.00	15	•	•	•	•	•	•	•		•
20	25	38	Minus	BPA20	15.00-20.00	20	•	•	•	•	•	•	•	•	•
25	25	38	48	BPA25	19.00-25.00	25	•	•	•	•	•	•	•	•	•
32	25	38		BPA32	24.00-32.00	30	•	•	•	•	•	•	•	•	•
40	30	45		BPA40	30.00-40.00	40	•	•	•	•	•	•	•	•	•

Max L₁ 32 Max L₁ 42

BPA Pilots conform to NAAMS™ standard for Ball Lock Pilot Punches

XL Overall Length Shortened
Stock removal from point end. Standard or Alternate L₁ length is maintained on BPA only.

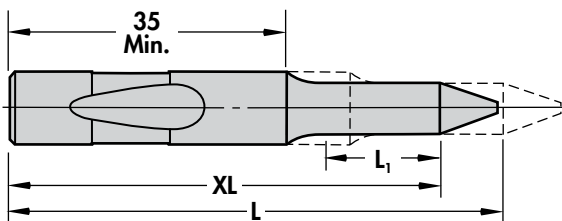

XLB Overall Length Shortened
L₁ length maintained.
(BPT only)
(Min. shank length 35)

How to Order:

Specify: Quantity
Type
Shank & Length Codes
P Dimensions
Standard Alterations

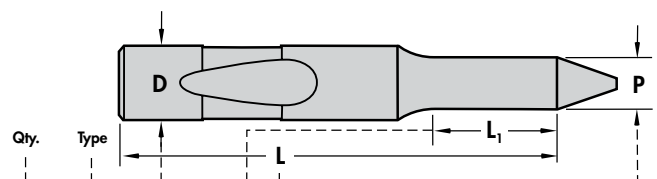

8 BPA 16 25 80 P12.0 M2
12 BPT 13 21 73 P8.4 PS4

See page 33 for coatings/treatments.

Heavy Duty Punch Blanks

Steel:	HRC
M2, PS4	60-63

Type
BJB and BPB
Jektol[®] Regular

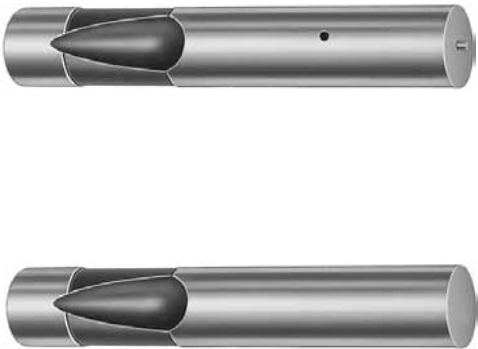
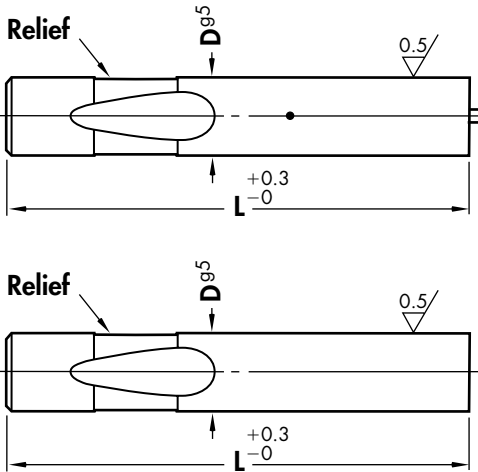
BJB

BPB

No side hole D32, 40

Jektol[®]

D	Type & D	L							Jektol Pin
		63	71	80	90	100	110	125	
10	BJB10	•	•	•	•	•			J4M
13	BJB13	•	•	•	•	•	•		J6M
16	BJB16	•	•	•	•	•	•		J6M
20	BJB20	•	•	•	•	•	•		J9M
25	BJB25		•	•	•	•	•		J9M
32	BJB32		•	•	•	•	•		J12M
40	BJB40			•	•	•	•		J12M

Regular

D	Type & D	L						
		63	71	80	90	100	110	125
10	BPB10	•	•	•	•	•	•	•
13	BPB13	•	•	•	•	•	•	•
16	BPB16	•	•	•	•	•	•	•
20	BPB20	•	•	•	•	•	•	•
25	BPB25		•	•	•	•	•	•
32	BPB32		•	•	•	•	•	•
40	BPB40			•	•	•	•	•

Standard Alterations for BZ and BK Punches

Standard Alterations are beyond those sizes listed above and can be manufactured for a slight additional charge.

See page 33 for coatings/treatments and shear angles.

XBR Point Length Shorter Than Standard on Point Larger than Shank Punches.
(Shortens punch from the point end.)

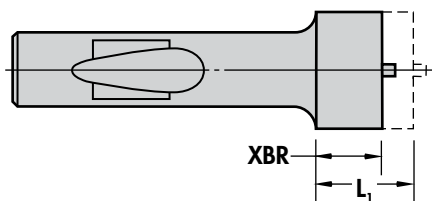

XL Overall Length Shortened
Stock removal from shank end on Point Larger than Shank Punches. *Does not alter ball seat location.*

Stock removal from point end on BJB and BPB blanks.

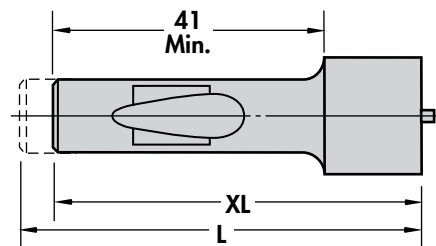

Steel:	HRC
M2	60-63

Heavy Duty

Point Larger than Shank Punches

Type
Jektole® BZ_ Regular BK_

B_H

B_K

B_J

B_N

B_V

B_X

B_O

B_R

B_L

B_Y

B_Z

1 Sharp corners are typical. To assure proper clearance, Dayton will provide standard broken corners if die button is ordered with punch to eliminate interference with die button fillet when total clearance is 0.08 or less.

2 Check your P&W dimensions to be sure the diagonal G does not exceed the max. shown.

$G = \sqrt{P^2 + W^2}$

Jektole

Point Length L ₁	Type & D	Round Range P	Type & D	Shape			L			Jektole Pin
				Min. XW	Min. W	Max. P/G	80	90	100	
19 30	BZX13	13.10-32.00	BZ_13	1.57	5.00-32.00		•	•	•	J6
19 30	BZX16	16.10-38.00	BZ_16	4.01	6.00-38.00		•	•	•	J6
19 30	BZX20	20.10-40.00	BZ_20	4.01	8.00-40.00		•	•	•	J9
19 30	BZX25	25.10-44.00	BZ_25	5.96	10.00-44.00		•	•	•	J9
19 30	BZX32	32.10-50.00	BZ_32	5.96	11.50-50.00		•	•	•	J12
19 30	BZX40	40.10-56.00	BZ_40	7.13	14.00-56.00		•	•	•	J12

Regular

Point Length L ₁	Type & D	Round Range P	Type & D	Shape			L		
				Min. XW	Min. W	Max. P/G	80	90	100
19 30	BKX13	13.10-32.00	BK_13	1.57	5.00-32.00		•	•	•
19 30	BKX16	16.10-38.00	BK_16	4.01	6.00-38.00		•	•	•
19 30	BKX20	20.10-40.00	BK_20	4.01	8.00-40.00		•	•	•
19 30	BKX25	25.10-44.00	BK_25	5.96	10.00-44.00		•	•	•
19 30	BKX32	32.10-50.00	BK_32	5.96	11.50-50.00		•	•	•
19 30	BKX40	40.10-56.00	BK_40	7.13	14.00-56.00		•	•	•

BZ & BK Punches conform to NAAMS™ standard for Ball Lock Punches

Standard Ball Seat Locations

Standard Ball Seat Location is at 90°. Alternate locations of 0°, 180°, or 270° can be specified at *no additional cost*.

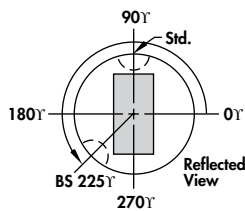

Custom Ball Seat Locations

Custom Ball Seat Locations can be specified as BS and degrees counter-clockwise from 0°.

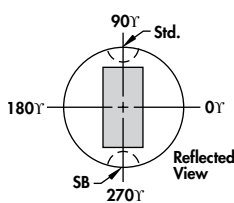

Double Ball Seat Locations

A second ball seat can be specified. Normally located 180° from the primary ball seat these are used to minimize sharpening of notching punches by rotating the punch 180°. Specify SB and degree desired. Can also be located 90° from primary ball seat. *Not recommended for shank diameters under 20.*

BZL & BKL Punches For Longer Life

Dayton's BZL & BKL punches with a constant corner radius of 0.5R puts the clearance where it's needed to prevent rapid wear and unacceptable burrs commonly generated with sharp corners. This reduces maintenance time and the risk of edge breaking during operation.

The "L" Long Life punch will reduce maintenance costs while increasing production runs by reducing corner wear.

How to Order:

Specify: Quantity
 Type
 Shank & Length Codes
 P or P&W Dimensions
 Standard Alterations

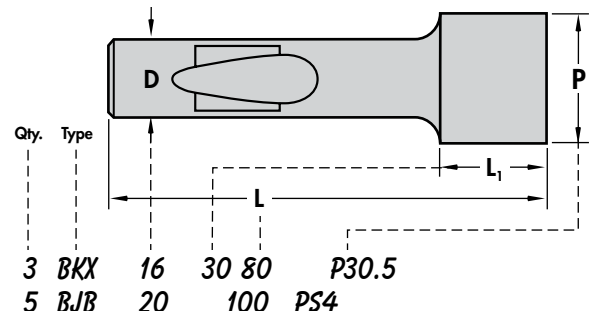

Light Duty Jektole® Punches

Steel:	HRC
A2, M2, PS4	60-63

ISO 10071 — Ejector Punches

Type
CJ_

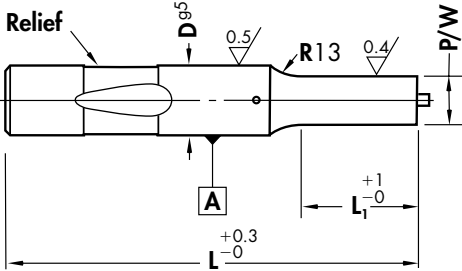

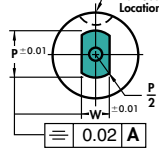

No side hole D32, 38

CJH

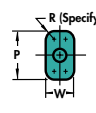

CJK



CJJ

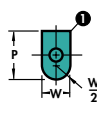

CJN

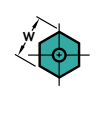

CJV

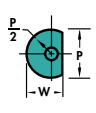

CJX

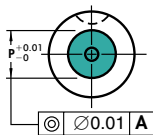

CJO

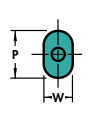

CJR

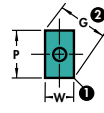

CJL

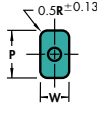

CJY

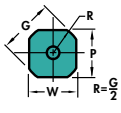

CJZ

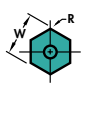

1 Sharp corners are typical. To assure proper clearance, Dayton will provide standard broken corners if die button is ordered with punch to eliminate interference with die button fillet when total clearance is 0.08 or less.

2 Check your P&W dimensions to be sure the diagonal G does not exceed the max. shown.

$G = \sqrt{P^2 + W^2}$

D	Point Length L ₁			Type & D	Round Range P	Type & D	Shape		L					Jektole Pin	
	Std.	Alt.	Alt.				Min. W	Max. P/G	63	71	80	90	100		
06	13	10*	—	CJX06	2.10- 5.97	CJ_06	2.10-	5.97	•	•	•	•	•	•	J3M**
10	19	10*	—	CJX10	2.10- 9.97	CJ_10	2.10-	9.97	•	•	•	•	•	•	J4M†
13	19	13	25	CJX13	5.00-12.97	CJ_13	4.50-	12.97	•	•	•	•	•	•	J6M
16	19	13	25	CJX16	8.00-15.97	CJ_16	6.00-	15.97	•	•	•	•	•	•	J6M
20	19	13	25	CJX20	12.00-19.97	CJ_20	8.00-	19.97	•	•	•	•	•	•	J9M
25	19	13	25	CJX25	16.00-24.97	CJ_25	10.00-	24.97	•	•	•	•	•	•	J9M
32	19	13	25	CJX32	24.00-31.97	CJ_32	12.50-	31.97	•	•	•	•	•	•	J12M
38	25	19	30	CJX38	30.00-37.97	CJ_38	14.00-	37.97	•	•	•	•	•	•	J12M

*Min P or W = 1.60 when L₁ = 10

** J2 (P < 2.0) †J2 (P < 3.0)

Standard Alterations for CJ and CP Punches

Standard Alterations are beyond those sizes listed above and can be manufactured for a slight additional charge.

XBB adds 3 days to delivery

L ₁ Max	XBR						XBB					
	13	19	25	30	35	40	13	19	25	30	35	40
D	Minimum P Rounds						Minimum W Shapes					
06	1.4	1.4	2.0	2.5	—	—	1.4	1.4	2.0	3.0	—	—
10	1.4	1.5	2.4	3.2	4.0	5.0	1.4	1.5	2.4	4.0	4.0	5.0
13	4.0	4.0	4.0	4.0	4.0	5.0	4.0	4.0	4.0	4.0	4.5	5.0
16	4.0	4.0	4.0	4.0	4.0	6.0	4.0	4.0	4.0	4.0	4.5	6.0
20	6.0	6.0	6.0	7.6	7.6	7.6	6.0	6.0	6.0	6.0	6.0	6.0
25	8.0	8.0	8.0	10.0	10.0	10.0	6.0	6.0	6.0	6.0	6.0	6.0
32	10.0	10.0	10.0	10.0	10.0	10.0	7.2	7.2	7.2	7.2	7.2	7.2
38	12.0	12.0	12.0	12.0	12.0	12.0	7.2	7.2	7.2	7.2	7.2	7.2

XP, XW P or W Dimensions Smaller than Standard

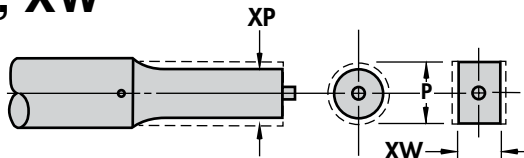

XBR Point Length Longer than Standard

Specify XBR or XBB and length (see chart at left)

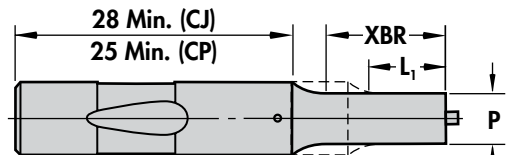

XL Overall Length Shortened

Stock removal from point end which shortens point length. To maintain point length specify XBR.

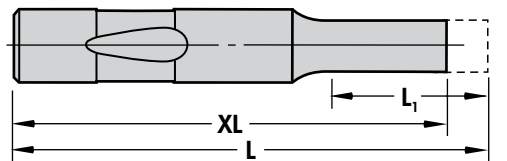

XLB Overall Length Shortened

L₁ length maintained. (See XBR for min. shank length)

WS Whistle Stop

The Whistle Stop alteration is ground through the ball seat, subject to the same limitations as other standard and custom ball seat locations. See page 10 for details.

Steel:	HRC
A2, M2, PS4	60-63

Light Duty Regular Punches

ISO 10071 — Non-ejector Punches

Type
CP_

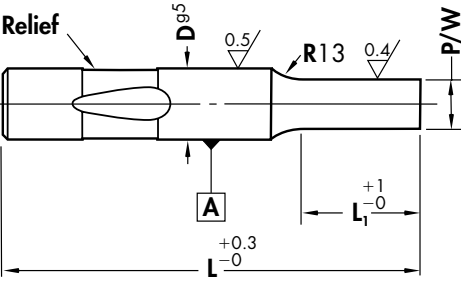
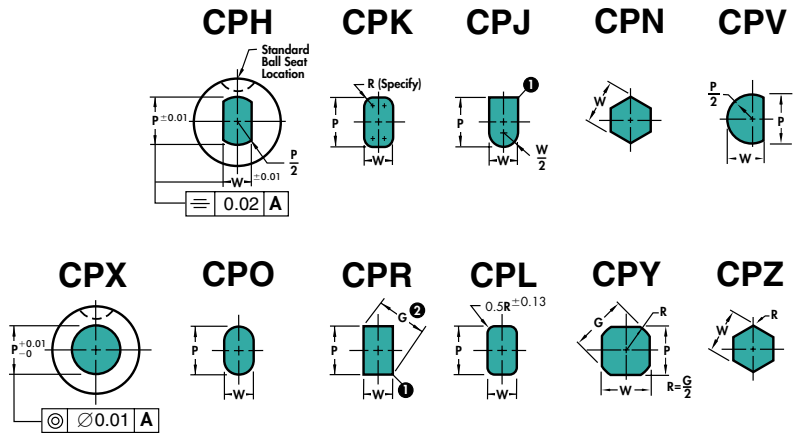
CPH **CPK** **CPJ** **CPN** **CPV**

CPX **CPO** **CPR** **CPL** **CPY** **CPZ**

1 Sharp corners are typical. To assure proper clearance, Dayton will provide standard broken corners if die button is ordered with punch to eliminate interference with die button fillet when total clearance is 0.08 or less.

2 Check your P&W dimensions to be sure the diagonal G does not exceed the max. shown.

$G = \sqrt{P^2 + W^2}$

D	Point Length L ₁			Type & D	Round Range P	Type & D	Shape		L				
	Std.	Alt.	Alt.				Min. W	Max. P/G	63	71	80	90	100
06	13	10*	—	CPX06	2.10- 5.97	CP_06	2.10-	5.97	•	•	•	•	•
10	19	10*	—	CPX10	2.10- 9.97	CP_10	2.10-	9.97	•	•	•	•	•
13	19	13	25	CPX13	5.00-12.97	CP_13	4.50-	12.97	•	•	•	•	•
16	19	13	25	CPX16	8.00-15.97	CP_16	6.00-	15.97	•	•	•	•	•
20	19	13	25	CPX20	12.00-19.97	CP_20	8.00-	19.97	•	•	•	•	•
25	19	13	25	CPX25	16.00-24.97	CP_25	10.00-	24.97	•	•	•	•	•
32	19	13	25	CPX32	24.00-31.97	CP_32	12.50-	31.97	•	•	•	•	•
38	25	19	30	CPX38	30.00-37.97	CP_38	14.00-	37.97	•	•	•	•	•

*Min P or W = 1.60 when L₁ = 10

See page 33 for coatings/treatments and shear angles.

XK No Side Hole
For air ejection.
No cost. Components
not supplied.

XJ Smaller Jektote
Components.
See page 29.

Standard Ball Seat Locations

Standard Ball Seat Location is at 90°. Alternate locations of 0°, 180°, or 270° can be specified at *no additional cost*.

Custom Ball Seat Locations

Custom Ball Seat Locations can be specified as BS and degrees counter-clockwise from 0°.

Double Ball Seat Locations

A second ball seat can be specified. Normally located 180° from the primary ball seat these are used to minimize sharpening of notching punches by rotating the punch 180°. Specify SB and degree desired. Can also be located 90° from primary ball seat. *Not recommended for shank diameters under 20.*

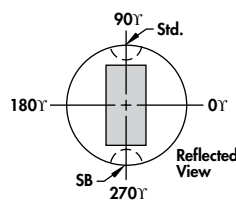
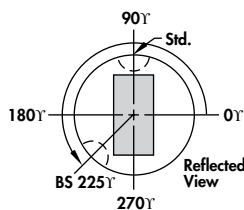

CJL & CPL Punches For Longer Life

Dayton's CJL & CPL punches with a constant corner radius of 0.5R puts the clearance where it's needed to prevent rapid wear and unacceptable burrs commonly generated with sharp corners. This reduces maintenance time and the risk of edge breaking during operation.

The "L" Long Life punch will reduce maintenance costs while increasing production runs by reducing corner wear.

How to Order:

Specify: Quantity
Type
Shank & Length Codes
P or P&W Dimensions
Steel
Standard Alterations

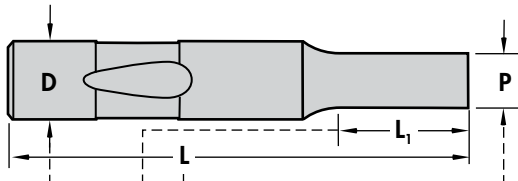

Qty.	Type	D	L	L ₁	P	Steel
6	CJX	10	19	80	P6.7	M2
10	CPO	13	13	71	P8.2, W6.9	PS4

Light Duty Regular Pilots

Steel:	HRC
A2, M2, PS4	60-63

ISO 10071

Type CPT

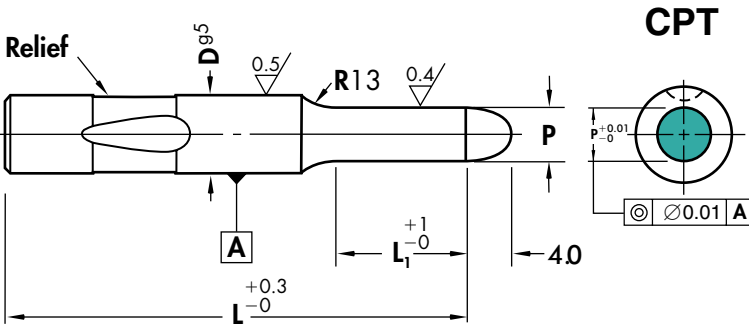

CPT

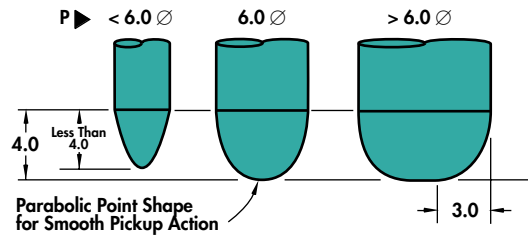

When P = D Shank tolerance applies to full length

D	Point Length L ₁			Type & D	Round Range P	L									
	Std.	Alt.	Alt.			65	73	82	92	102	112	127			
06	15	12*	—	CPT06	2.05- 6.00	•	•	•	•	•					
10	21	12*	—	CPT10	2.05-10.00	•	•	•	•	•	•				
13	21	15	27	CPT13	4.95-13.00	•	•	•	•	•	•	•			
16	21	15	27	CPT16	7.95-16.00		•	•	•	•	•	•	•		
20	21	15	27	CPT20	11.95-20.00		•	•	•	•	•	•	•	•	
25	21	15	27	CPT25	15.95-25.00		•	•	•	•	•	•	•	•	•
32	21	15	27	CPT32	23.95-32.00			•	•	•	•	•	•	•	•
38	27	21	32	CPT38	29.95-38.00				•	•	•	•	•	•	•

*Min. P = 1.55 when L₁ = 12

Standard Alterations for CPT and CPA Pilots

Standard Alterations are beyond those sizes listed above and can be manufactured for a slight additional charge.

XBB and X3B adds 3 days to delivery

L ₁ Max	CPA CPT	XBR			XBB			X3B			
		13	19	25	30	35	40	50	60	70	
		15	21	27	32	37	42	—	—	—	
		Minimum P									
D		06	1.40	1.40	1.95	2.45	—	—	—	—	—
		10	1.40	1.45	2.35	3.15	3.95	4.95	5.95	5.95	7.95
		13	2.05	2.35	3.15	3.15	3.95	4.95	5.95	5.95	7.95
		16	3.95	3.95	3.95	3.95	3.95	5.95	5.95	5.95	7.95
		20	5.95	5.95	5.95	7.55	7.55	7.55	7.55	7.55	7.95
		25	7.95	7.95	7.95	9.95	9.95	9.95	9.95	9.95	9.95
		32	9.95	9.95	9.95	9.95	9.95	9.95	9.95	9.95	9.95
		38	11.95	11.95	11.95	11.95	11.95	11.95	11.95	11.95	11.95

Shaded Area for CPA Only

XP P Dimensions Smaller than Standard

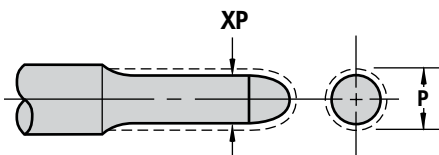

Point Length Longer than Standard

Specify XBR, XBB, or X3B and length (see chart at left)

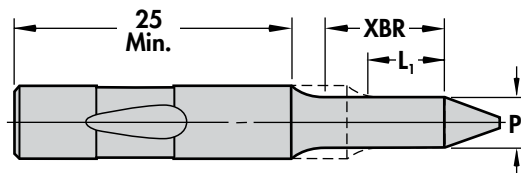

WS Whistle Stop

See table for standard angles. The Whistle Stop alteration is ground through the ball seat, subject to the same limitations as other standard and custom ball seat locations. Angles of 5° and 7.5° also available on 16 and larger diameters. (Specify XA and angle after WS.)

Example: CPA20 110, P17.00, M2, WS, XA 7.5°

D	A°
6, 10	5°
13	7.5°
16-38	10°

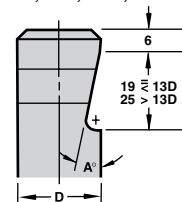

Steel:	HRC
M2	60-63

Light Duty Positive Pick-up Pilots

Order any length from 71 through 150mm

Type
CPA

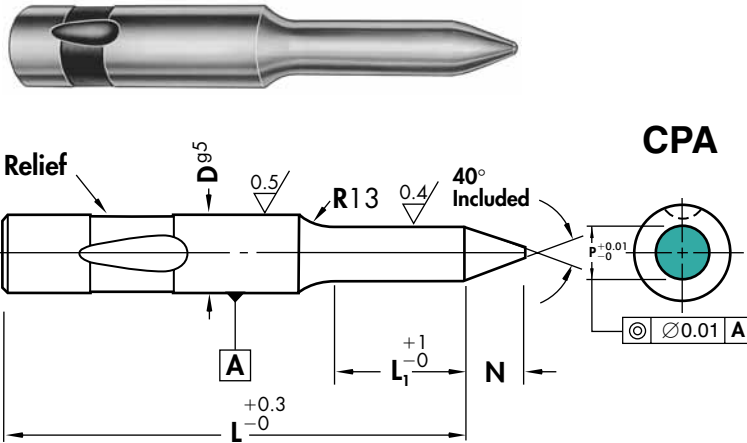

Relief D_{95} 0.5 R13 0.4 40° Included $P_{+0.01}^{-0}$ $\text{◎} \text{ } \varnothing 0.01 \text{ } | \text{ } A$

When $P=D$ Shank tolerance applies to full length

Geometry provides smoother pick-up without the risk of distorting the hole.

Greater Positioning moves the stock further than conventional pilots.

D	Point Length L_1			Type & D	Round Range P	N	L									
	Std.	Alt.	Alt.				71	80	90	100	110	125	140	150		
10	19	32		CPA10	5.00-10.00	8	•	•	•	•	•					
13	19	32		CPA13	9.00-13.00	10	•	•	•	•	•	•				
16	25	38	L	CPA16	12.00-16.00	15	•	•	•	•	•	•	•			
20	25	38	Minus	CPA20	15.00-20.00	20	•	•	•	•	•	•	•	•		
25	25	38	38	CPA25	19.00-25.00	25	•	•	•	•	•	•	•	•	•	
32	25	38		CPA32	24.00-32.00	30		•	•	•	•	•	•	•	•	
38	30	45		CPA38	30.00-38.00	35		•	•	•	•	•	•	•	•	

Max. L_1 33 Max. L_1 42

XL Overall Length Shortened
Stock removal from point end. Standard or Alternate L_1 length is maintained on CPA only.

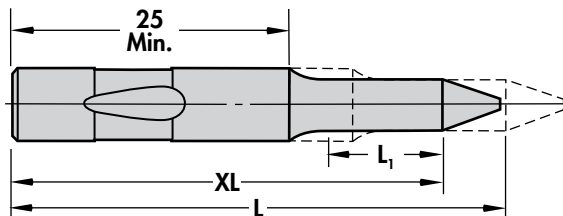

XLB Overall Length Shortened
 L_1 length maintained. (CPT only) (Min. shank length 25)

See page 33 for coatings/treatments.

How to Order:

Specify: Quantity
Type
Shank & Length Codes
P Dimensions
Steel
Standard Alterations

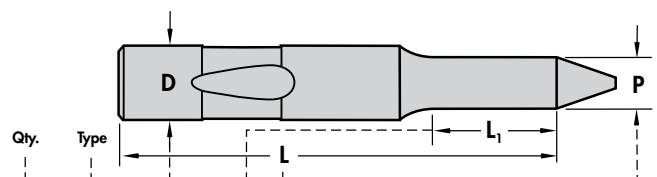

8 CPA 16 25 80 P12.0
12 CPT 13 21 73 P8.4 A2

Light Duty Punch Blanks

Steel:	HRC
A2, M2, PS4	60-63

ISO 10071

Type
CJB and CPB
Jektole® Regular

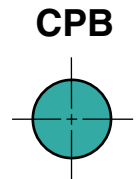
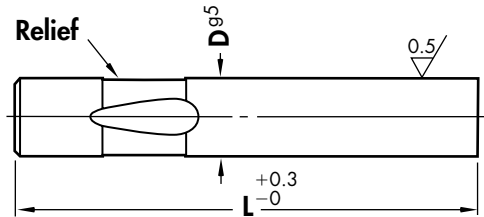
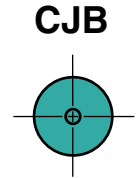
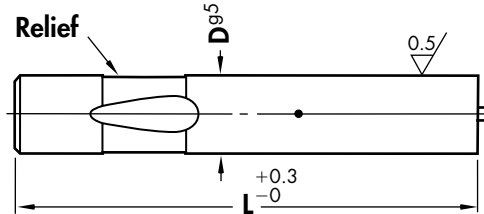

No side hole D32, 38

Jektole

D	Type & D	L					Jektole Pin
		63	71	80	90	100	
06	CJB06	•	•	•	•	•	J3M
10	CJB10	•	•	•	•	•	J4M
13	CJB13	•	•	•	•	•	J6M
16	CJB16	•	•	•	•	•	J6M
20	CJB20	•	•	•	•	•	J9M
25	CJB25	•	•	•	•	•	J9M
32	CJB32		•	•	•	•	J12M
38	CJB38			•	•	•	J12M

Regular

D	Type & D	L				
		63	71	80	90	100
06	CPB06	•	•	•	•	•
10	CPB10	•	•	•	•	•
13	CPB13	•	•	•	•	•
16	CPB16	•	•	•	•	•
20	CPB20	•	•	•	•	•
25	CPB25	•	•	•	•	•
32	CPB32		•	•	•	•
38	CPB38			•	•	•

Standard Alterations for CZ and CK Punches

Standard Alterations are beyond those sizes listed above and can be manufactured for a slight additional charge.

See page 33 for coatings/treatments and shear angles.

WS Whistle Stop

See table for standard angles. The Whistle Stop alteration is ground through the ball seat, subject to the same limitations as other standard and custom ball seat locations. Angles of 5° and 7.5° also available on 16 and larger diameters. (Specify XA and angle after WS.)

Example: CPB20 100, M2, WS, XA 7.5°

D	A°
6, 10	5°
13	7.5°
16-38	10°

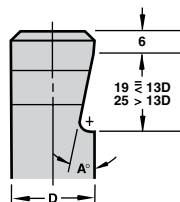

XBR Point Length Shorter Than Standard on Point Larger than Shank Punches.

(Shortens punch from the point end.)

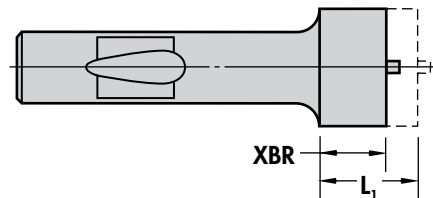

XL Overall Length Shortened

Stock removal from shank end on Point Larger than Shank Punches. Does not alter ball seat location.

Stock removal from point end on CJB and CPB Blanks.

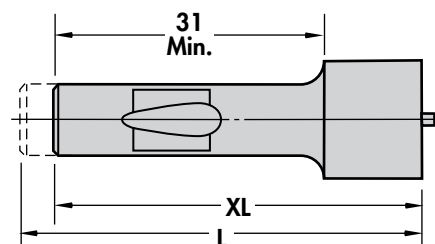

Steel:	HRC
A2, M2	60-63

Light Duty

Point Larger than Shank Punches

Type
Jektol® CZ_ Regular CK_

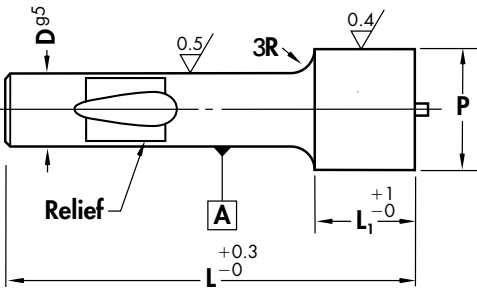
C_H **C_K** **C_J** **C_N** **C_V**

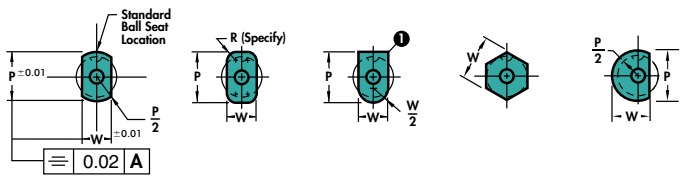

C_X **C_O** **C_R** **C_L** **C_Y** **C_Z**

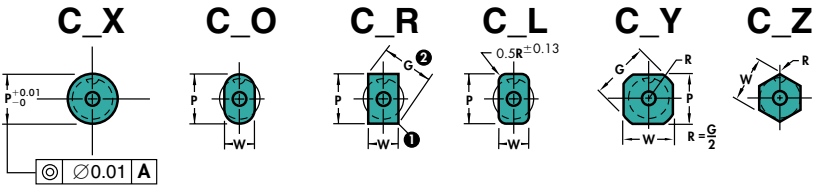

① Sharp corners are typical. To assure proper clearance, Dayton will provide standard broken corners if die button is ordered with punch to eliminate interference with die buton fillet when total clearance is 0.08 or less.

② Check your P&W dimensions to be sure the diagonal G does not exceed the max. shown.

$G = \sqrt{P^2 + W^2}$

Jektol

Regular

Point Length L ₁ Std. Alt.	Type & D	Round Range P	Type & D	Shape			L			Jektol Pin
				Min. XW	Min. W	Max. P/G	80	90	100	
19 30	CZX13	13.10-32.00	CZ_13	1.57	5.00-32.00		•	•	•	J6
19 30	CZX16	16.10-38.00	CZ_16	4.01	6.00-38.00		•	•	•	J6
19 30	CZX20	20.10-40.00	CZ_20	4.01	8.00-40.00		•	•	•	J9
19 30	CZX25	25.10-44.00	CZ_25	5.96	10.00-44.00		•	•	•	J9
19 30	CZX32	32.10-50.00	CZ_32	5.96	11.50-50.00		•	•	•	J12

Point Length L ₁ Std. Alt.	Type & D	Round Range P	Type & D	Shape			L		
				Min. XW	Min. W	Max. P/G	80	90	100
19 30	CKX13	13.10-32.00	CK_13	1.57	5.00-32.00		•	•	•
19 30	CKX16	16.10-38.00	CK_16	4.01	6.00-38.00		•	•	•
19 30	CKX20	20.10-40.00	CK_20	4.01	8.00-40.00		•	•	•
19 30	CKX25	25.10-44.00	CK_25	5.96	10.00-44.00		•	•	•
19 30	CKX32	32.10-50.00	CK_32	5.96	11.50-50.00		•	•	•

Standard Ball Seat Locations

Standard Ball Seat Location is at 90°. Alternate locations of 0°, 180°, or 270° can be specified at *no additional cost*.

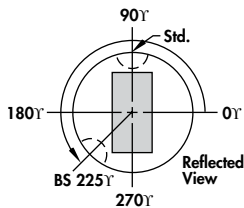

Custom Ball Seat Locations

Custom Ball Seat Locations can be specified as BS and degrees counter-clockwise from 0°.

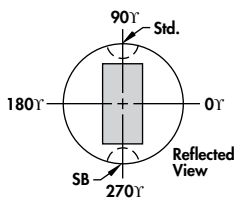

Double Ball Seat Locations

A second ball seat can be specified. Normally located 180° from the primary ball seat these are used to minimize sharpening of notching punches by rotating the punch 180°. Specify SB and degree desired. Can also be located 90° from primary ball seat. *Not recommended for shank diameters under 20.*

CZL & CKL Punches For Longer Life

Dayton's CZL & CKL punches with a constant corner radius of 0.5R puts the clearance where it's needed to prevent rapid wear and unacceptable burrs commonly generated with sharp corners. This reduces maintenance time and the risk of edge breaking during operation.

The "L" Long Life punch will reduce maintenance costs while increasing production runs by reducing corner wear.

How to Order:

Specify: Quantity
Type
Shank & Length Codes
P or P&W Dimensions
Steel
Standard Alterations

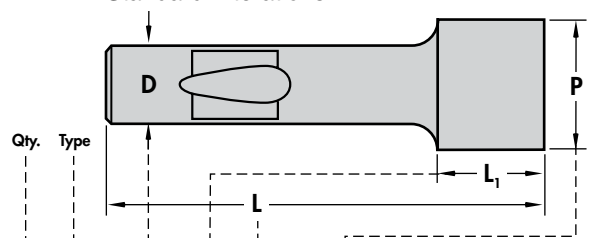

3 CKX 16 30 80 P30.5 M2
5 CJB 20 100 A2

Die Buttons

Steel	HRC
A2, M2	60-63

Headless — ISO 8977 (Round Only)

Type **AD_**
Headless

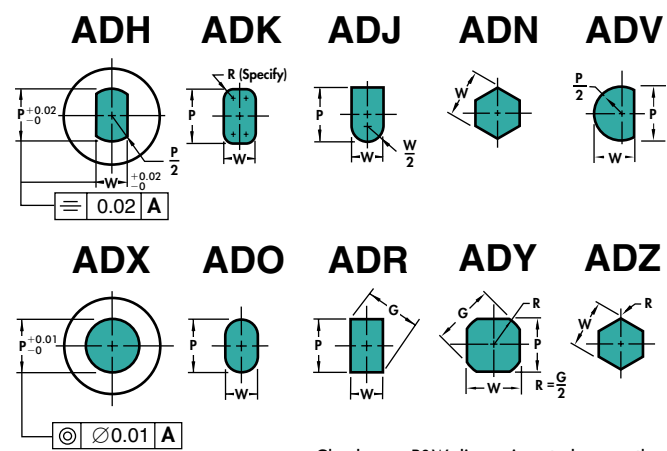
Press-in Lead

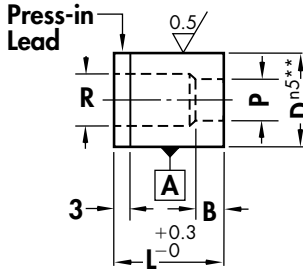

Check your P&W dimensions to be sure the diagonal G does not exceed the max. shown.
 $G = \sqrt{P^2 + W^2}$

Body D	Std. S	B Alt. A	Alt. B	Type & D	Round Range P	Type & D	Shape Min. W	Max. P/G	R	L								
										20	22	25	28	30	32	35	40	
08	4	—	—	ADX08	1.50- 2.40	—	—	—	3.5	•	•	•	•	•	•	•	•	•
	4	—	—	ADX08	2.41- 3.00	—	—	—	4.0	•	•	•	•	•	•	•	•	•
	4	8	—	ADX08	3.01- 3.20	—	—	—	4.0	•	•	•	•	•	•	•	•	•
10	4	—	—	ADX10	1.50- 2.40	AD_10	—	—	3.5	•	•	•	•	•	•	•	•	•
	4	—	—	ADX10	2.41- 3.00	AD_10	—	—	4.0	•	•	•	•	•	•	•	•	•
	4	8	—	ADX10	3.01- 3.20	AD_10	1.20- 3.20	—	4.0	•	•	•	•	•	•	•	•	•
	4	8	—	ADX10	3.21- 5.00	AD_10	1.20- 5.00	—	6.0	•	•	•	•	•	•	•	•	•
13	5	—	—	ADX13	1.50- 2.40	AD_13	—	—	3.5	•	•	•	•	•	•	•	•	•
	5	—	—	ADX13	2.41- 3.00	AD_13	—	—	4.0	•	•	•	•	•	•	•	•	•
	5	8	—	ADX13	3.01- 3.20	AD_13	—	—	4.0	•	•	•	•	•	•	•	•	•
	5	8	—	ADX13	3.21- 5.00	AD_13	2.00- 5.00	—	6.0	•	•	•	•	•	•	•	•	•
	5	8	—	ADX13	5.01- 7.20	AD_13	2.00- 7.20	—	8.0	•	•	•	•	•	•	•	•	•
16	5	8	—	ADX16	5.00- 7.20	AD_16	2.40- 7.20	—	8.0	•	•	•	•	•	•	•	•	•
	5	8	—	ADX16	7.21- 8.80	AD_16	2.40- 8.80	—	9.5	•	•	•	•	•	•	•	•	•
20	5	12	20	ADX20	7.00- 8.80	AD_20	3.20- 8.80	—	9.5	•	•	•	•	•	•	•	•	•
	5	12	20	ADX20	8.81-11.00	AD_20	3.20-11.00	—	12.0	•	•	•	•	•	•	•	•	•
22	6	12	20	ADX22	9.00-14.00	AD_22	4.00-14.00	—	15.0	•	•	•	•	•	•	•	•	•
25	6	12	20	ADX25	11.00-14.00	AD_25	4.80-14.00	—	15.0	•	•	•	•	•	•	•	•	•
	6	12	20	ADX25	14.01-16.50	AD_25	4.80-16.50	—	17.5	•	•	•	•	•	•	•	•	•
32	6	12	20	ADX32	13.00-16.50	AD_32	5.50-16.50	—	17.5	•	•	•	•	•	•	•	•	•
	6	12	20	ADX32	16.51-20.00	AD_32	5.50-20.00	—	21.0	•	•	•	•	•	•	•	•	•
38	8	12	20	ADX38	16.00-20.00	AD_38	6.40-20.00	—	21.0	•	•	•	•	•	•	•	•	•
	8	12	20	ADX38	20.01-26.00	AD_38	6.40-26.00	—	27.0	•	•	•	•	•	•	•	•	•
40	8	12	20	ADX40	16.00-20.00	AD_40	6.40-20.00	—	21.0	•	•	•	•	•	•	•	•	•
	8	12	20	ADX40	20.01-26.00	AD_40	6.40-26.00	—	27.0	•	•	•	•	•	•	•	•	•

Standard Alterations for AD and CD (page 17) Die Buttons

Standard Alterations are beyond those sizes listed above and can be manufactured for a slight additional charge.

Press-Fit AD_					Ball Lock CD_			
D	Min. P	Min. W	Max. P/G	R	Min. P	Min. W	Max. P/G	Max. R
10	1.5*	1.2	5.5	6.0	—	—	—	—
13	1.5*	1.2	7.5	8.0	—	—	—	—
16	3.0	2.0	9.0	9.5	—	1.2	6.3	7.1
20	5.0	2.4	11.5	12.0	3.8	2.4	11.9	12.7
22	7.0	3.2	14.5	15.0	—	—	—	—
25	9.0	4.0	17.0	17.5	5.1	4.0	16.5	17.5
32	11.0	4.8	20.5	21.0	6.4	4.8	21.4	22.2
38	13.0	5.5	26.5	27.0	7.6	5.5	28.0	28.7
40	13.0	5.5	26.5	27.0	—	—	—	—
45	16.0	6.4	35.0	36.0	—	—	—	—
50	19.0	8.0	40.0	41.0	—	—	—	—
56	22.0	9.0	45.0	46.0	—	—	—	—
63	25.0	10.0	50.0	51.0	—	—	—	—
71	28.0	11.0	56.0	57.0	—	—	—	—
76	31.0	12.0	60.0	61.0	—	—	—	—
85	39.0	15.0	66.0	67.0	—	—	—	—
90	43.0	21.0	70.0	71.0	—	—	—	—
100	45.0	25.0	78.0	79.0	—	—	—	—

*3.00 min. P at 8mm Land Length

XP, XW P or W Dimensions Larger or Smaller than Standard

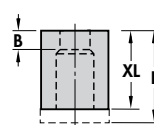
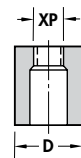

XL Overall-Length Shortened

Stock removal does not alter B length.
Minimum overall length = 6.35
Not available on Ball Lock Buttons.

LL Precision Overall-Length

Same as XL except overall length is held to ± 0.02 .
Not available on Ball Lock Buttons.

Body D	Std. S	B Alt. A	Alt. B	Type & D	Round Range P	Type & D	Shape Min. W	Max. P/G	R	L							
										22	25	28	30	32	35	40	45
45	8	12	20	ADX45	19.00-26.00	AD_45	8.00-26.00		27.0	•	•	•	•	•	•	•	•
	8	12	20	ADX45	26.01-35.00	AD_45	8.00-35.00		36.0	•	•	•	•	•	•	•	•
50	8	12	20	ADX50	22.00-26.00	AD_50	— —		27.0	•	•	•	•	•	•	•	•
	8	12	20	ADX50	26.01-35.00	AD_50	9.00-35.00		36.0	•	•	•	•	•	•	•	•
	8	12	20	ADX50	35.01-40.00	AD_50	9.00-40.00		41.0	•	•	•	•	•	•	•	•
56	8	12	20	ADX56	25.00-35.00	AD_56	10.00-35.00		36.0	•	•	•	•	•	•	•	•
	8	12	20	ADX56	35.01-40.00	AD_56	10.00-40.00		41.0	•	•	•	•	•	•	•	•
	8	12	20	ADX56	40.01-45.00	AD_56	10.00-45.00		46.0	•	•	•	•	•	•	•	•
63	8	12	20	ADX63	28.00-35.00	AD_63	— —		36.0	•	•	•	•	•	•	•	•
	8	12	20	ADX63	35.01-40.00	AD_63	11.00-40.00		41.0	•	•	•	•	•	•	•	•
	8	12	20	ADX63	40.01-45.00	AD_63	11.00-45.00		46.0	•	•	•	•	•	•	•	•
	8	12	20	ADX63	45.01-50.00	AD_63	11.00-50.00		51.0	•	•	•	•	•	•	•	•
71	8	12	20	ADX71	31.00-40.00	AD_71	12.00-40.00		41.0	•	•	•	•	•	•	•	•
	8	12	20	ADX71	40.01-45.00	AD_71	12.00-45.00		46.0	•	•	•	•	•	•	•	•
	8	12	20	ADX71	45.01-50.00	AD_71	12.00-50.00		51.0	•	•	•	•	•	•	•	•
	8	12	20	ADX71	50.01-56.00	AD_71	12.00-56.00		57.0	•	•	•	•	•	•	•	•
76	8	12	20	ADX76	39.00-45.00	AD_76	15.00-45.00		46.0	•	•	•	•	•	•	•	•
	8	12	20	ADX76	45.01-50.00	AD_76	15.00-50.00		51.0	•	•	•	•	•	•	•	•
	8	12	20	ADX76	50.01-56.00	AD_76	15.00-56.00		57.0	•	•	•	•	•	•	•	•
	8	12	20	ADX76	56.01-60.00	AD_76	15.00-60.00		61.0	•	•	•	•	•	•	•	•
85	8	12	20	ADX85	43.00-50.00	AD_85	21.00-50.00		51.0	•	•	•	•	•	•	•	•
	8	12	20	ADX85	50.01-56.00	AD_85	21.00-56.00		57.0	•	•	•	•	•	•	•	•
	8	12	20	ADX85	56.01-60.00	AD_85	21.00-60.00		61.0	•	•	•	•	•	•	•	•
	8	12	20	ADX85	60.01-66.00	AD_85	21.00-66.00		67.0	•	•	•	•	•	•	•	•
90	8	12	20	ADX90	45.00-50.00	AD_90	25.00-50.00		51.0	•	•	•	•	•	•	•	•
	8	12	20	ADX90	50.01-56.00	AD_90	25.00-56.00		57.0	•	•	•	•	•	•	•	•
	8	12	20	ADX90	56.01-60.00	AD_90	25.00-60.00		61.0	•	•	•	•	•	•	•	•
	8	12	20	ADX90	60.01-66.00	AD_90	25.00-66.00		67.0	•	•	•	•	•	•	•	•
	8	12	20	ADX90	66.01-70.00	AD_90	25.00-70.00		71.0	•	•	•	•	•	•	•	•
100	8	12	20	ADX100	50.00-56.00	AD_100	33.00-56.00		57.0	•	•	•	•	•	•	•	•
	8	12	20	ADX100	56.01-60.00	AD_100	33.00-60.00		61.0	•	•	•	•	•	•	•	•
	8	12	20	ADX100	60.01-66.00	AD_100	33.00-66.00		67.0	•	•	•	•	•	•	•	•
	8	12	20	ADX100	66.01-70.00	AD_100	33.00-70.00		71.0	•	•	•	•	•	•	•	•
	8	12	20	ADX100	70.01-78.00	AD_100	33.00-78.00		79.0	•	•	•	•	•	•	•	•

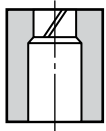

XSC Slug Control eliminates slug pulling. Dayton Slug Control is as easy as specifying a catalog number. Add the information that is unique to your application to the die button catalog number. See ordering information.

Dayton Slug Control is Easy to Order

Dayton Slug Control is as easy as specifying a catalog number. Add the information that is unique to your application to the die button catalog number. See the example below.

You must specify **XSC** for alteration, **material thickness** and **clearance per side** as a percent.

Catalog Number				Your Specs		
ADX	13	25	P7.0	XSC	MM0.3	C55
Type	D	L	P	Alteration Code	Material Thickness (mm)	Clearance Per Side (%)

This information will be entered into our computer to generate a program to alter the land of the die button and end your slug pulling problems forever! Call us or contact your Dayton distributor for more information.

Standard Key Flat Location

Standard Key Flat Location is 0°. Alternative locations of 90°, 180°, or 270° can be specified at no additional cost.

Custom Key Flat Location

Custom Key Flat Locations can be specified as degree required counterclockwise from 0°. See page 20 for more details.

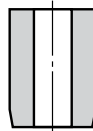
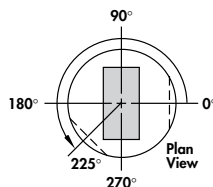

XBL Straight Through Land. The land length (B) equals the overall length of the die button. Can be used for bushings, guides and a variety of other applications.

*Round dies only.

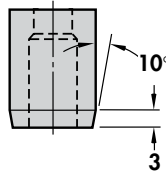

XAL 10° Angled Lead on AD_. The angle provides clearance for steps left by CNC machining.

Standard on AN_-Die Buttons

XN DayTride®. A unique wear-resistant surface treatment for M2 only.

How to Order:

Specify: Quantity
Type
Body Dia. & B and Overall Length Codes
P or P & W Dimensions
Standard Alterations

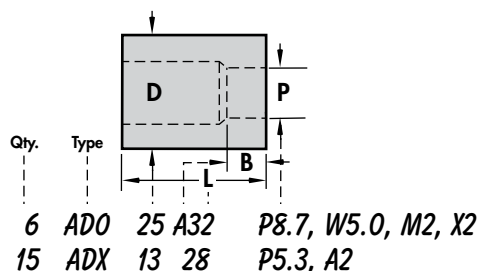

Tapered Relief Die Buttons

Steel	HRC
A2, M2	60-63

For automotive CNC build applications

Ordering Example: ANO 25 A32 P8.7 W5.0 X43

Type AN_ 

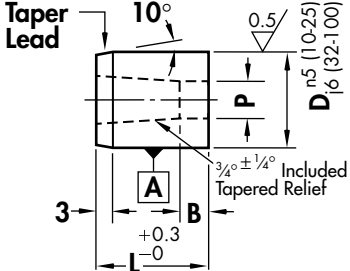

ANX ANH ANK ANJ ANO ANR
ANN ANV ANY ANZ

Shown above with Locking Device X43 for Ø6 Dowel (NAAMS™ standard). X43 provided unless otherwise specified.

Check your P&W dimensions to be sure the diagonal G does not exceed the max. shown.
 $G = \sqrt{P^2 + W^2}$

See page 20 for other Locking Devices (must be specified)

Body D	Std. S	B Alt. A	Alt. B	Type & D	Round Range P	Type & D	Shape Min. W	Max. P/G	L												
									13	16	20	22	25	28	30	32	35	40			
10	4	5	3	ANX10	1.60- 6.80	AN_10	1.30- 6.80														
13	5	8	3	ANX13	3.00- 8.80	AN_13	1.90- 8.80														
16	5	8	3	ANX16	7.40-10.80	AN_16	1.90-10.80														
20	5	10	3	ANX20	9.50-13.60	AN_20	1.90-13.60														
22	6	10	3	ANX22	10.50-15.00	AN_22	1.90-15.00														
25	6	10	3	ANX25	12.00-17.00	AN_25	1.90-17.00														
32	6	12	3	ANX32	16.00-22.00	AN_32	1.90-22.00														
38	8	12	3	ANX38	18.00-27.00	AN_38	1.90-27.00														
40	8	12	3	ANX40	18.00-27.00	AN_40	1.90-27.00														
45	8	12	3	ANX45	18.00-35.00	AN_45	2.40-35.00														
50	8	12	3	ANX50	18.00-40.00	AN_50	4.00-40.00														
56	8	12	3	ANX56	18.00-45.00	AN_56	4.00-45.00														
63	8	12	3	ANX63	18.00-50.00	AN_63	4.00-50.00														
71	8	12	3	ANX71	18.00-56.00	AN_71	4.00-56.00														
76	8	12	3	ANX76	25.00-60.00	AN_76	5.60-60.00														
85	8	12	3	ANX85	25.00-66.00	AN_85	5.60-66.00														
90	8	12	3	ANX90	32.00-70.00	AN_90	5.60-70.00														
100	8	12	3	ANX100	32.00-78.00	AN_100	5.60-78.00														

Standard Alterations for AN Die Buttons

XP, XW P or W Dimensions Larger or Smaller than Standard



XL Overall-Length Shortened
Minimum overall length = 6.35

LL Precision Overall-Length
Same as XL except overall length is held to ±0.02.

No lead when L < 12.7

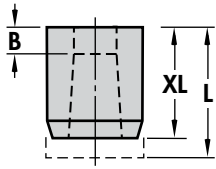

XBL Straight Through Land
The land length (B) equals the overall length of the die button. Can be used for bushings, guides and a variety of other applications.

*Round dies only.



XSC Slug Control eliminates slug pulling
Dayton Slug Control is as easy as specifying a catalog number. Add the information that is unique to your application to the die button catalog number. See ordering information on page 15.

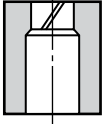

XAR Increased Taper Relief (10° per side max) Standard. B length unless XB is specified. Default angle is 1° when an angle is not specified.

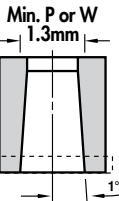

XN DayTride®
A unique wear-resistant surface treatment for M2 only.

Steel:	HRC
A2	60-63

Light Duty Ball Lock Die Buttons

Ordering Example: CDO 25 32 P8.7 W5.0

Type **CD_**

CDH CDK CDJ

CDX CDO CDR

CDN CDV CDY CDZ

Check your P&W dimensions to be sure the diagonal G does not exceed the max. shown.
 $G = \sqrt{P^2 + W^2}$

Standard Ball Seat Locations
 Standard Ball Seat Location is at 90°. Alternate locations of 0°, 180°, or 270° can be specified at *no additional cost*.

Custom Ball Seat Locations
 Custom Ball Seat Locations can be specified as BS and degrees counter-clockwise from 0°.

Double Ball Seat Locations
 A second ball seat can be specified. Normally located 180° from the primary ball seat these are used to minimize sharpening of die buttons in notching operations by rotating 180°. Specify SB and degree desired. Can also be located 90° from primary ball seat.

Body Dia. D	B	Max. R	Type & D	Range P	Type & D	Min. W	Max. P/G	L
								32
13	4	6.0	CDX13	1.50- 5.00	CD_13	1.20- 5.00		•
16	5	8.0	CDX16	3.20- 7.20	CD_16	2.00- 7.20		•
20	5	12.0	CDX20	4.00-11.00	CD_20	2.40-11.00		•
25	6	16.0	CDX25	8.00-15.00	CD_25	4.00-15.00		•
32	6	20.0	CDX32	11.00-19.00	CD_32	4.80-19.00		•
38	8	27.0	CDX38	16.50-26.00	CD_38	6.40-26.00		•

Type **ADE/ADU**

ADE

ADU

All dimensions and tolerances are the same unless specified.

Steel	HRC
A2, M2	60-63

EDM Button Blanks

How to Order:
 Specify: Quantity
 Type
 Body Dia. & Length Codes
 B&P Dimensions if Required

8 ADE 40-A35 M2
2 ADU 13-30 A2

For the fastest delivery use the hole (P) dimensions given in the chart. If another hole is desired simply specify "XP" and give the dimension.

Type	Body D	P	ADE			ADE R	L									
			Std. S	Alt. A	Alt. B		20	22	25	28	30	32	35	40		
ADE ADU	8	0.8	—	—	—	—	•	•	•	•	•	•	•	•	•	•
	10	0.8	4	8	—	6.0	•	•	•	•	•	•	•	•	•	•
	13	1.6	5	8	—	8.0	•	•	•	•	•	•	•	•	•	•
	16	1.6	5	8	—	9.5	•	•	•	•	•	•	•	•	•	•
	20	1.6	5	12	20	12.0	•	•	•	•	•	•	•	•	•	•
	22	1.6	6	12	20	15.0	•	•	•	•	•	•	•	•	•	•
	25	1.6	6	12	20	17.5	•	•	•	•	•	•	•	•	•	•
	32	1.6	6	12	20	21.0	•	•	•	•	•	•	•	•	•	•
	38	1.6	8	12	20	27.0	•	•	•	•	•	•	•	•	•	•
	40	1.6	8	12	20	27.0	•	•	•	•	•	•	•	•	•	•
	45	3.2	8	12	20	36.0	•	•	•	•	•	•	•	•	•	•
	50	3.2	8	12	20	41.0	•	•	•	•	•	•	•	•	•	•
	56	3.2	8	12	20	46.0	•	•	•	•	•	•	•	•	•	•
	63	3.2	8	12	20	51.0	•	•	•	•	•	•	•	•	•	•
	71	3.2	8	12	20	57.0	•	•	•	•	•	•	•	•	•	•
	76	3.2	8	12	20	61.0	•	•	•	•	•	•	•	•	•	•
85	3.2	8	12	20	67.0	•	•	•	•	•	•	•	•	•	•	
90	3.2	8	12	20	71.0	•	•	•	•	•	•	•	•	•	•	
100	3.2	8	12	20	79.0	•	•	•	•	•	•	•	•	•	•	

*For diameters 32-100 add XDT-j6 to the end of the catalog number to receive NAAMS™ standard j6 tolerance for large diameters.

Classified Shapes

Standard Ball Seat Locations

The Standard Ball Seat location is at 90°. Alternative locations of 0°, 180° or 270° can be specified *at no extra cost*.

Custom Ball Seat Locations

Custom Ball Seat locations can be specified as BS and degrees counterclockwise from 0°.

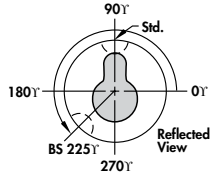

Views

Views are: reflected view of punch and plan view of die button.

Corner Dimensions

Dimensions should be to the theoretical sharp corners for C22, C24, C25, C34, C61 and C88. Some reduction of these dimensions will result from fitting the punch and die button under conditions where clearance is 0.04 or less per side.

Fillets matched with sharp corners reduces the clearance per side (Δ). If the clearance is 0.04³ or less, DAYTON will break sharp corners when the punches and die buttons are ordered together. This reduces assembly time and the risk of the edge breaking during operation. All back-holes are counterbored.

Shape Centers

Shapes are centered on punch shanks as shown. Shaped in die buttons are also centered as shown with the exception of shapes C22 and C34. Due to the clearance, the P dimension on these shapes will not be centered.

How to Order:

Specify: Quantity
Catalog Number
Classified Shape
Code
Point or Hole Dimensions

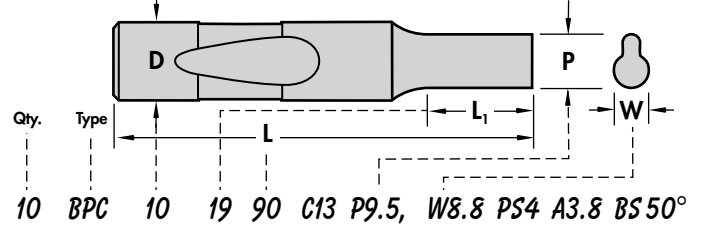

Example: Die Buttons

10 ADC 20 30 C13 P9.5 W8.8 A3.8 M2 30.1 X73 50°

Clearance

To assure proper relationship with punches, it is necessary to specify punch dimensions and clearance per side (Δ) when ordering die buttons.

DAYTON will assure the proper clearance of die buttons to the punch when ordered in this manner.

Notes 1 and 2 — Fillets and Sharp Corners

Normal grinding methods produce:

- 1 0.2 max fillet on the punch, matching corner sharp on the die button.
- 2 0.2 max fillet on the die button, matching corner sharp on the punch.

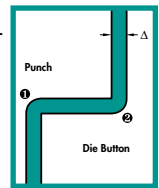

Simplified Specifications...83 Common Shapes—No Detailing Required

Flatted Rounds

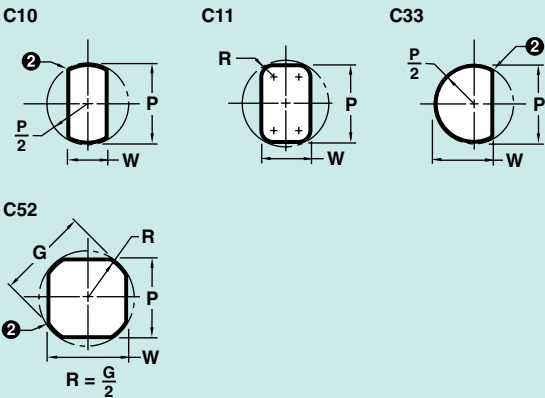

Mono Lobes

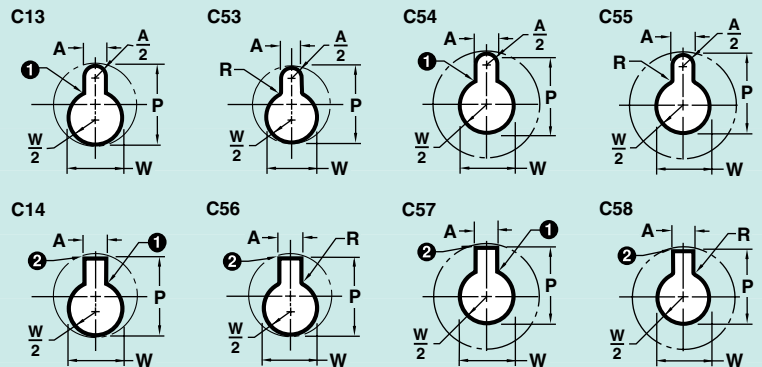

Miscellaneous

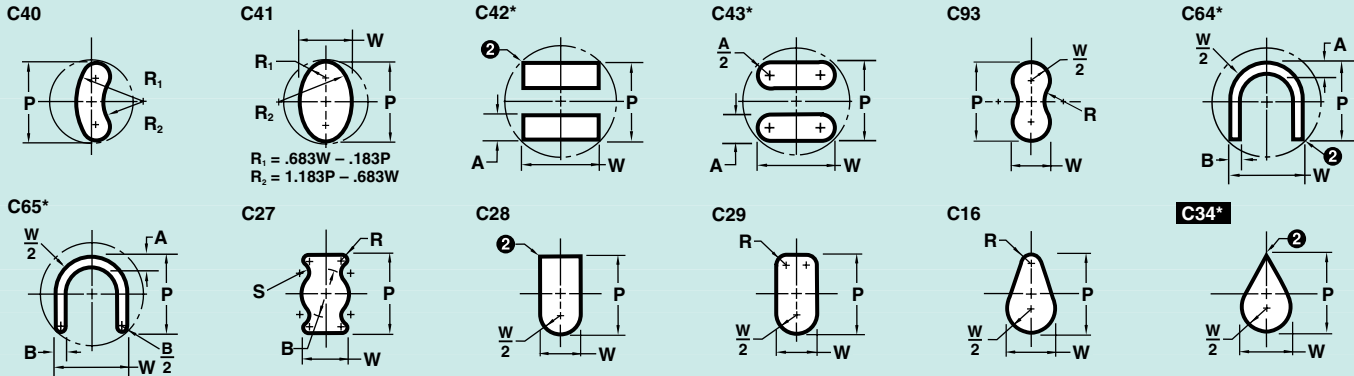

Triangles/Trapezoids

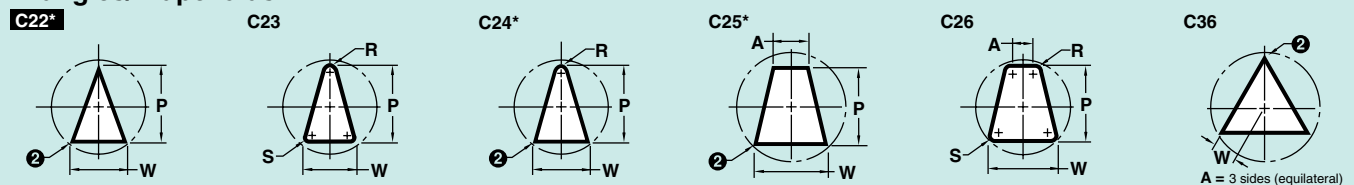

Keys

C30

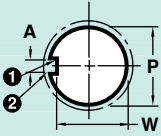

C31

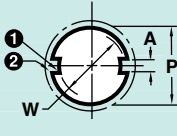

C32

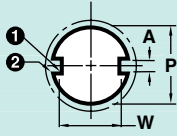

C61

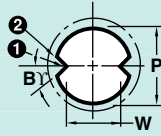

C62

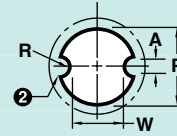

Polygons

C12

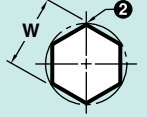

C85

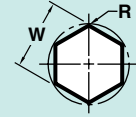

C35

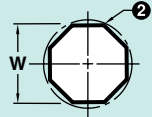

A = Even No. of Sides

C86

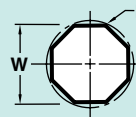

A = Even No. of Sides

C36

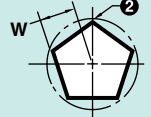

A = Odd No. of Sides

C87

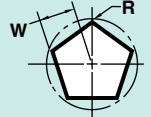

A = Odd No. of Sides

C88

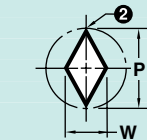

C89

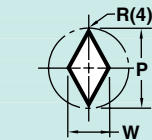

C37

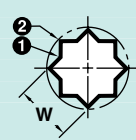

C38

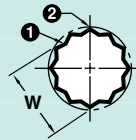

C39

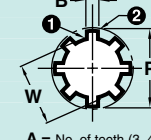

A = No. of teeth (3, 4, 6 or 8 only)

C90*

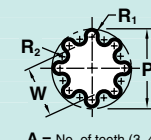

A = No. of teeth (3, 4, 6 or 8 only)

Multi Lobes

C19

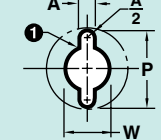

C59

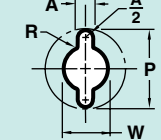

C20

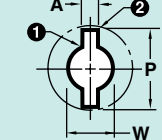

C60

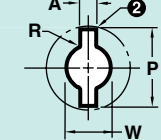

C17

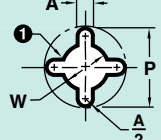

C18

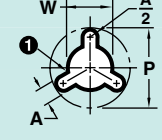

Duo Tees

C21*

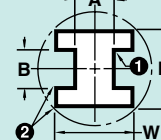

C91*

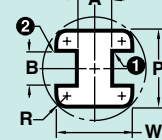

C92

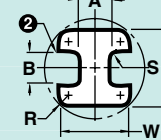

C15*

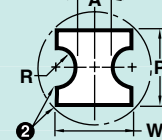

T's

C44*

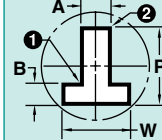

C66*

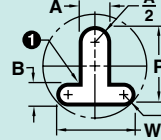

C45*

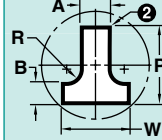

C67*

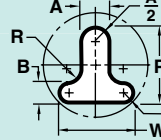

L's

C46*

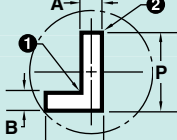

C77*

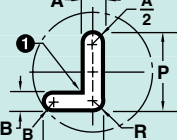

C78*

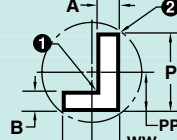

C79*

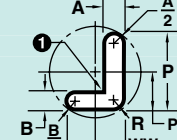

C48*

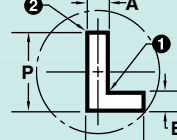

C80*

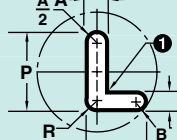

C81*

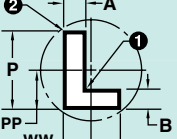

C82*

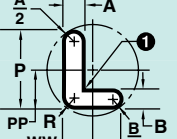

C47*

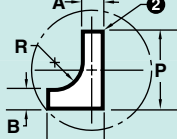

C83*

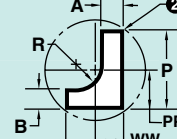

C49*

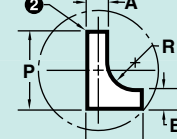

C84*

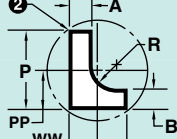

U's

C50*

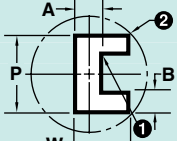

C68*

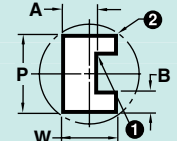

C69*

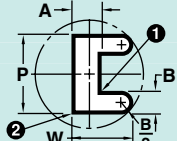

C70*

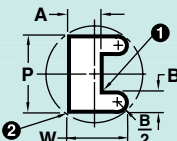

C71*

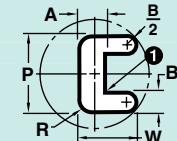

C72*

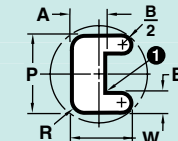

C51*

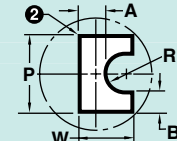

C73*

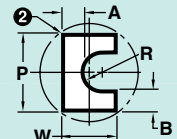

C74*

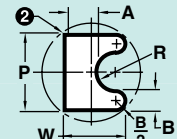

C75*

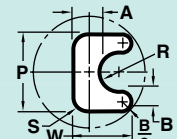

C76*

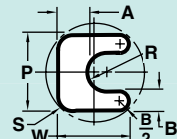

*Avoid excessive overhang by specifying shaped back-hole on AD_ and CD_ or use AN_ Die Buttons.

Locking Devices

How to Order:

5 ADO 40 30 P16, W6.4, X20
9 ADR 100 35 P75, W50, X83

Standard/ Alternate Locations

Definitions:
Standard Location is at 0°.
Alternate Location is 90°, 180° or 270°. Alternate Locations are available at no additional charge.

Custom Locations

Definition:
Custom Location is *any angle other than*: 0°, 90°, 180° or 270°.

Single and Double Flats

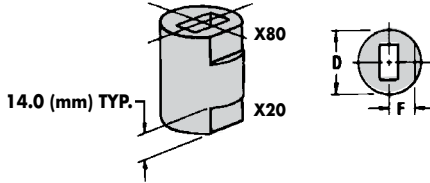

Headless Die Buttons: X20, X80, X50, X90

Body Ø ▶	08	10	13	16	20
F	3.5	4.0	5.5	7.0	8.5
Body Ø ▶	22	25	32	38	40
F	9.5	11.0	14.0	17.0	18.0
Body Ø ▶	45	50	56	63	71
F	20.5	23.0	26.0	29.5	33.5
Body Ø ▶	76	85	90	100	
F	35.5	40.0	42.5	47.5	

Single Flats: X2, X20, X80

Locking Devices	Die Button
X20	Bottom
X80	Top

Order Example:
X20 - 90°

Single Flats: X5, X50, X90

Locking Devices	Die Button
X50	Bottom
X90	Top

Order Example:
X50 - 135°

Additional Flats

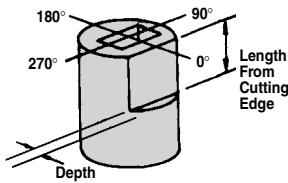

Additional Flats

Code	Depth	Length
X81	1.5	13
X82	1.5	16
X83	1.5	20
X84	1.5	Full Length
X85	2.5	13
X86	2.5	16
X87	2.5	20
X88	2.5	Full Length
X89	Specify Dimensions	

Additional Flats

Code	Depth	Length
X91	1.5	13
X92	1.5	16
X93	1.5	20
X94	1.5	Full Length
X95	2.5	13
X96	2.5	16
X97	2.5	20
X98	2.5	Full Length
X99	Specify Dimensions	

Dowel Slots

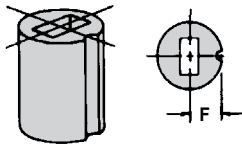

Dowel Slots: X0*, X4, X41 & X43

Locking Devices	Dowel Ø
X0*	3
X4	3
X41	4
X43	6

Order Example:
X0 - 180°

Dowel Slots: X1*, X7, X71 & X73

Locking Devices	Dowel Ø
X1*	3
X7	3
X71	4
X73	6

Order Example:
X71 - 135°

Dowel Slot F Dimension for Headless Die Buttons Only

Body Ø ▶	08	10	13	16-25	32-100
X0/X1	.5D	.5D	.5D	.5D	.5D
X4/X7	4.7	5.5	6.7	.5D	.5D
X41/X71	5.2	6.0	7.2	.5D	.5D
X43/X73	6.2	7.0	8.2	.5D+1.0	.5D

Key Flats vs. Dowel Slots

Maximum hole dimensions in die buttons were designed with key flats in mind. There are instances where, if using a dowel slot, the dowel hole could break into the relief. For this reason there are two ways to specify the location of the dowel. **X0** (standard/alternate location) and **X1**

(custom location) are located .5D from centerline. However, when hole dimensions are approaching the high limit of "P" **X4** (standard/alternate location) or **X7** (custom location) may be specified. This relocates the dowel outward to assure no interference between the dowel and relief.

*Available on headless die buttons only



Change Retainers

Reversible Air Cylinder Type

— For Ball Lock Punches

BRAR
For Heavy Duty Punches

US Patent# 7,204,181 B2
EU Patent# 1763423
JP Patent# 2007-519396

The BRAR Reversible Change Retainer is a unique air cylinder type change retainer that gives you the ability to change hole-punching patterns quickly and easily.

The BRAR holds the punch in two different locations: one, the NAAMS™ standard location; two, 12mm closer to the front of the retainer. (See drawings for holder configurations.)

This design allows a variety of punch configurations (e.g., right- and left-hand parts); the punch holder can be quickly and easily reversed, then changed back; and lead wires (attached to the control panel) show the on/off status of the cylinder.

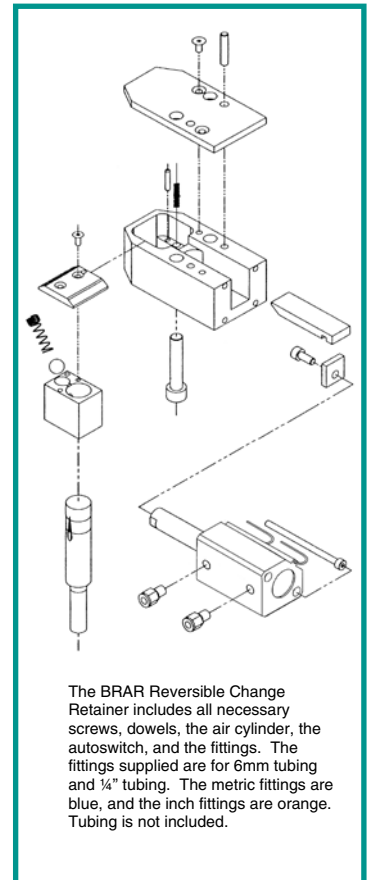
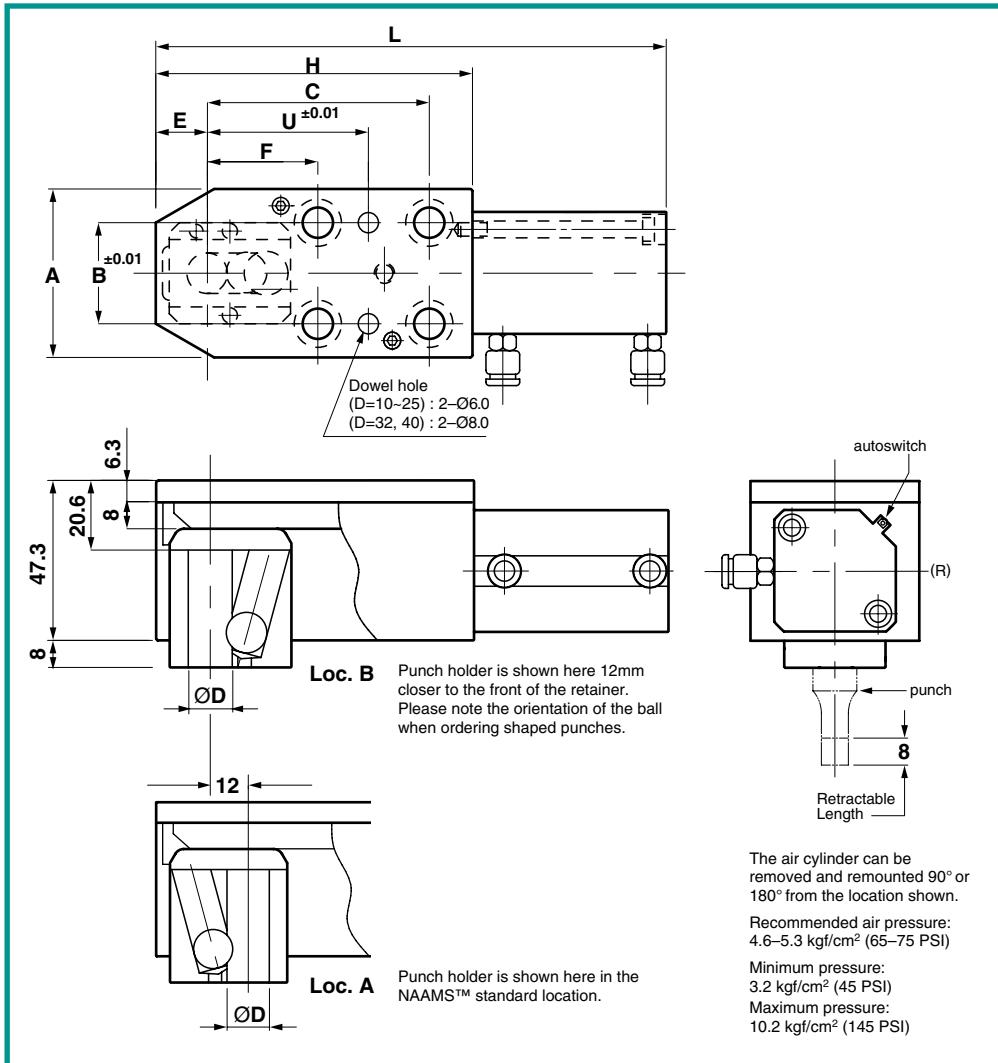

How To Order:

Quantity 6
Catalog No. BRAR 25

Catalog Number		D	L	A	B	C		E		F		H	U		Screw Size
Heavy Duty	Code					Loc. A	Loc. B	Loc. A	Loc. B	Loc. A	Loc. B		Loc. A	Loc. B	
BRAR	10	10	161	46	30	—	—	28	16	21	33	93.5	37	49	M8
BRAR	13	13	172.5	50	30	—	—	28	16	25	37	100	41	53	M10
BRAR	16	16	177	50	30	—	—	31	19	25	37	104.5	41	53	M10
BRAR	20	20	191.5	58	38	—	—	32.5	20.5	29	41	113.5	45	57	M10
BRAR	25	25	206.5	58	38	—	—	35	23	29	41	123.5	45	57	M10
BRAR	32	32	260	80	56	100	112	38	26	38	50	152	60	72	M12
BRAR	40	40	264	80	56	100	112	42	30	38	50	156	60	72	M12

BRAR Reversible Change Retainers conform to NAAMS™ standard for Ball Lock Punch Change Retainers.

Change Retainers

Air Cylinder Type

— For Ball Lock Punches



BRA
For Heavy Duty Punches

Engage or disengage punches in seconds

Change Retainers are used where different hole patterns are required. Various hole patterns can be accomplished without the need for multiple dies. Different parts, such as right and left hand can be run in one die.

Changing hole patterns takes only minutes, sometimes only seconds. A bar holding the punch in position is released to allow the punch to retract up far enough to avoid contact with the material.

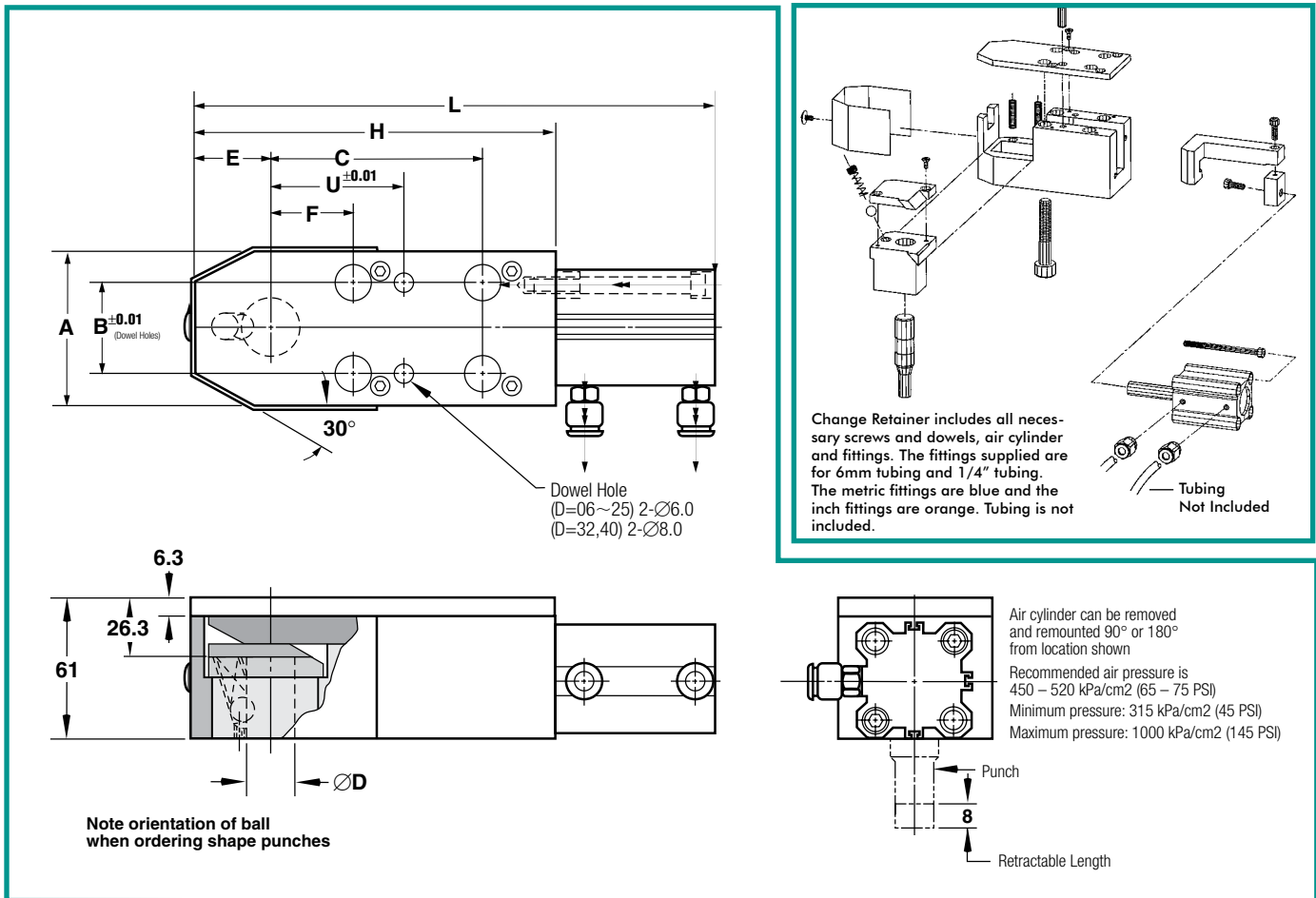

How To Order:

Quantity Catalog No.
6 BRA20

Catalog Number		D	L	A	B	C	E	F	H	U	Screw Size
Heavy Duty	Code										
BRA	10	10.0	172	46	30	53	32	21	114	37	M8
BRA	13	13.0	183	50	30	57	34	25	120	41	M10
BRA	16	16.0									
BRA	20	20.0	204	58	38	61	37	29	136	45	M10
BRA	25	25.0									
BRA	32	32.0	257	80	56	100	44	38	174	60	M12
BRA	40	40.0									

BRA Change Retainers conform to NAAMS™ standard for Ball Lock Punch Change Retainers

TRUE POSITION® Heavy Duty/Light Duty Retainers

...The interchangeable retainer that is the industry standard

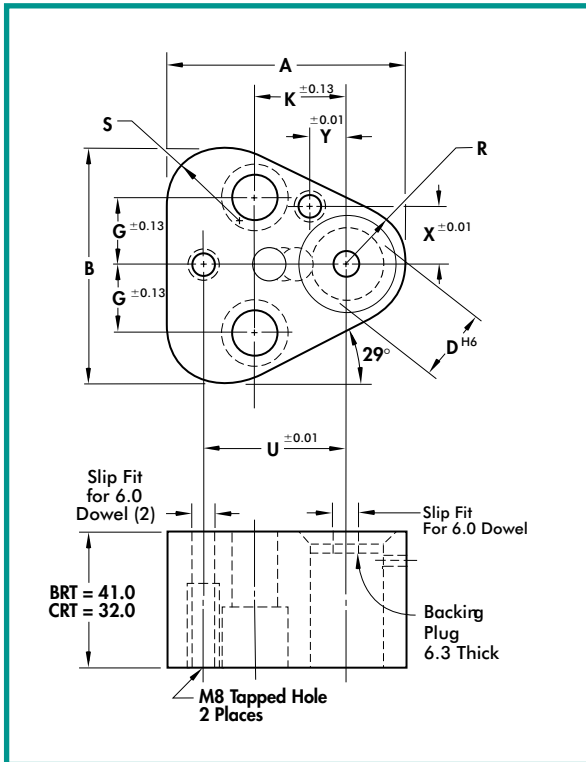

- The in-line dowel guarantees precise punch-to-button alignment. You gain higher quality parts, longer punch life and drastically reduced downtime.
- True-Position retainers eliminate hand fitting and cut mounting time by nearly 50%. Simply pull the retainer from its box and screw it to the die set. True Position retainers give you dimensional accuracy *every* time.
- Shaped punches use the secondary dowel for precise alignment; round punches need only one.
- The precision-ground ball hole assures perfect alignment of *any* punch shape—even if you replace the retainer.
- Tapped ball release hole.
- True Position adaptability can cut your retainer inventory in half.



- TRUE POSITION Retainer includes:**
- 1 Ball • 1 Spring
 - 2 Screws
 - 2 Threaded Dowels
 - 1 Ball Release Screw

How to Order:

Quantity	Catalog No.
10	BRT10
13	CRT25

BRT conforms to NAAMS™ standard for Ball Lock Punch Retainer

Catalog Number Heavy Duty	Catalog Number Light Duty	Code	D	A	B	G	K	R	S	U	X	Y	Screw Size
BRT	CRT	10	10.00	44.5	43.7	11.1	19.0	9.5	12.0	26.925	9.0	7.5	M8
BRT	CRT	13	13.00	50.8	50.0	14.3	19.0	12.7	15.2	29.970	12.0	6.5	M8
BRT	CRT	16	16.00	54.0	53.2	15.9	19.0	14.3	16.8	31.750	13.5	6.0	M8
BRT	CRT	20	20.00	60.3	59.5	17.5	19.0	17.5	20.0	33.530	16.5	5.0	M10
BRT	CRT	25	25.00	69.9	69.1	19.8	23.8	22.2	24.7	40.640	22.0	7.0	M12
BRT	CRT	32	32.00	69.9	69.1	19.8	23.8	22.2	24.7	40.640	22.0	7.0	M12
—	CRT	38	38.00	77.4	76.6	24.0	27.0	26.0	28.5	43.993	26.0	10.0	M12
BRT	—	40	40.00	77.4	76.6	24.0	27.0	26.0	28.5	43.993	26.0	10.0	M12

Retainers with Backing Plate

BRTB True Position® Retainers come complete with an **integrated, hardened backing plate**. With all the features of the original True Position® Retainer, the BRTB satisfies the needs of applications where more bearing surface is desired. True Position® gives you true dimensional accuracy each and every time!



BRTB
Heavy Duty



Retainer sets include:

- Ball
- Spring
- Screws
- Dowels
- Ball Release Set Screw

How to Order:

Quantity Catalog No.
13 BRTB25

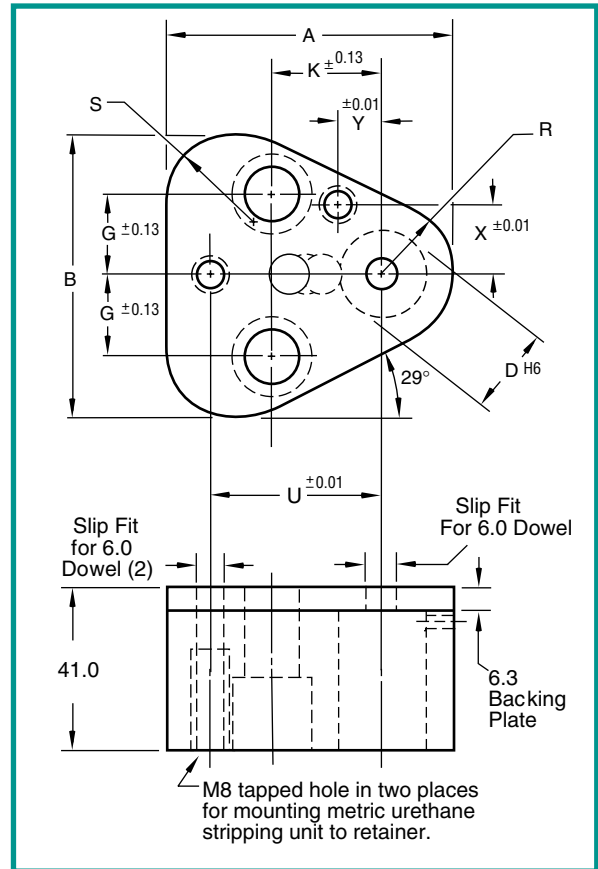

Back Plate	Code	D	A	B	G	K	R	S	U	X	Y	Screw Size
BRTB	10	10.00	44.5	43.7	11.1	19.0	9.5	12.0	26.925	9.0	7.5	M8
BRTB	13	13.00	50.8	50.0	14.3	19.0	12.7	15.2	29.970	12.0	6.5	M8
BRTB	16	16.00	54.0	53.2	15.9	19.0	14.3	16.8	31.750	13.5	6.0	M8
BRTB	20	20.00	60.3	59.5	17.5	19.0	17.5	20.0	33.530	16.5	5.0	M10
BRTB	25	25.00	69.9	69.1	19.8	23.8	22.2	24.7	40.640	22.0	7.0	M12
BRTB	32	32.00	69.9	69.1	19.8	23.8	22.2	24.7	40.640	22.0	7.0	M12
BRTB	40	40.00	77.4	76.6	24.0	27.0	26.0	28.5	43.993	26.0	10.0	M12

BRTB conforms to NAAMS™ standard for Ball Lock Punch Retainer

Heavy Duty/Light Duty Ultra-Compact Retainers

Single Ball Lock Compact Retainers

Space-Saving, time-saving retainers for round punches and pilots

- The industry's smallest interchangeable retainer, so you can fit more holes into tight spaces.
- Ultra-Compact retainers eliminate hand fitting and cut mounting time by nearly 50%. Simply pull the retainer from its box and screw it to the die set.
- A single dowel in the hardened backing plug is all you need for perfect alignment.
- Tapped ball release hole.
- Also interchangeable with the True Position Retainer.

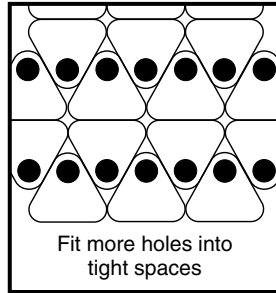

How to Order:

Quantity	Catalog No.
23	NRT10
15	TRT25



ULTRA COMPACT Retainer includes:

- 1 Ball • 1 Spring • 2 Screws
- 1 Threaded Dowel
- 1 Ball Release Screw

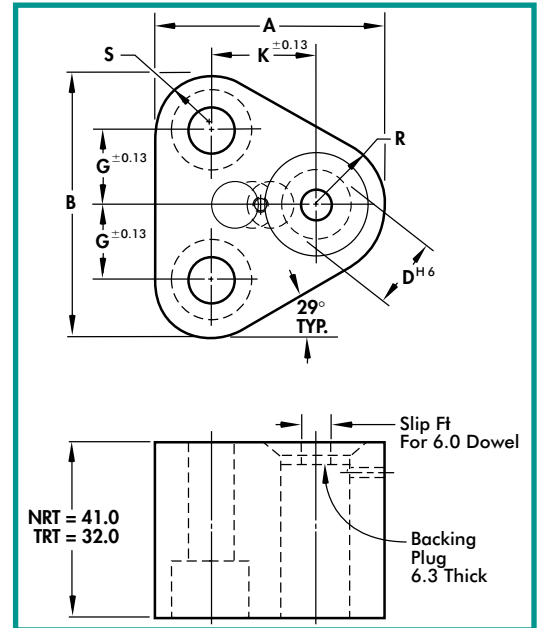

Catalog Number		Code	D	A	B	G	K	R	S	Screw Size
Heavy Duty	Light Duty									
NRT	TRT	10	10.00	38.5	40.6	11.1	19.0	9.5	9.5	M8
NRT	TRT	13	13.00	41.7	47.9	14.3	19.0	12.7	9.5	M8
NRT	TRT	16	16.00	43.3	51.6	15.9	19.0	14.3	9.5	M8
NRT	TRT	20	20.00	47.5	57.9	17.5	19.0	17.5	11.0	M10
NRT	TRT	25	25.00	59.2	68.8	19.8	23.8	22.2	16.5	M12
NRT	TRT	32	32.00	59.2	68.8	19.8	23.8	22.2	16.5	M12
NRT	—	40	40.00	69.0	76.5	24.0	27.0	26.0	22.0	M12

Multi-Position™ Retainers

For Ball Lock Punches

BRP Heavy Duty
CRP Light Duty

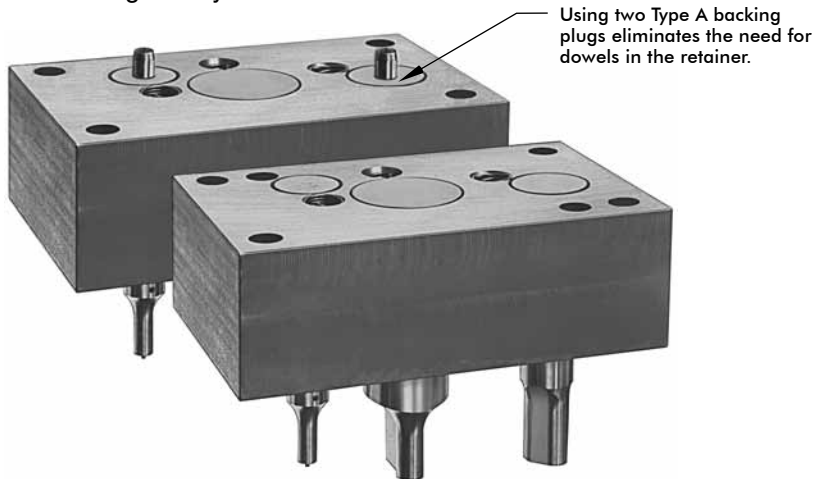

Dayton's innovative Multi-Position retainers provide a simple, low-cost solution to building new dies. These retainers reduce the need for special detailing, save both design and build time.

Multi-Position retainers are easy to order. Simply specify BRP for Heavy Duty or CRP for Light Duty Ball Lock retainers followed by the catalog number, hole locations and hole sizes. (For more information, see How to Order example on the next page.) Order forms are available on request.

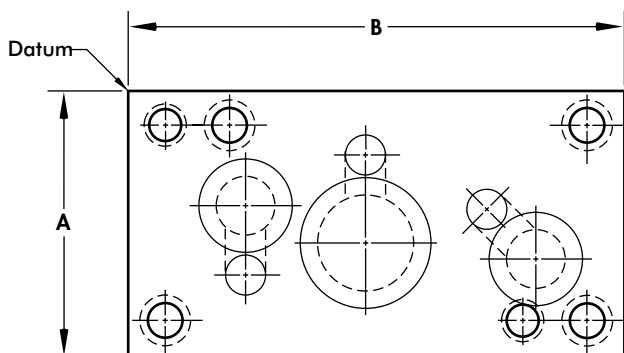

Note:
Looking at retainer from backing plug side.

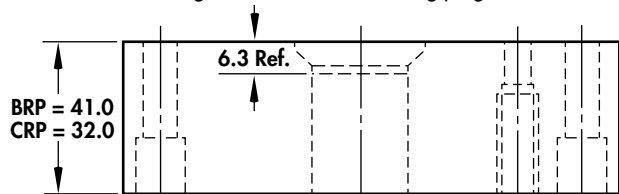

Specify screw and dowel size and location.

Tapped Hole Under Dowel

Backing Plugs

TYPE A	TYPE B	TYPE C
In-Line Dowel	For Die Buttons	Solid

The Type C solid backing plug is standard. However, as shown in the photo above left, you can use two Type A plugs with 6.0 diameter dowels for location. This eliminates the cost of dowel holes in the retainer.

See page 29 to order Backing Plugs.

Die Button Retainers require detailed drawings.

∅ Dowel	3	4	5	6	8	10	12	13	16
Tapped Hole	M5	M6	M8	M8	M10	M14	M14	M16	M20

Type	A	B											
		60	70	80	90	100	125	150	175	200	225	250	300
BRP	50	5060	5070	5080	5090	50100	50125	50150	50175	50200	50225	50250	50300
CRP	60	6060	6070	6080	6090	60100	60125	60150	60175	60200	60225	60250	60300
	70		7070	7080	7090	70100	70125	70150	70175	70200	70225	70250	70300
	80			8080	8090	80100	80125	80150	80175	80200	80225	80250	80300
	100					100100	100125	100150	100175	100200	100225	100250	100300
	125						125125	125150	125175	125200	125225	125250	125300
	150						150150	150175	150200	150225	150250	150300	
	200							200175	200200	200225	200250	200300	

Ball Hole Locations

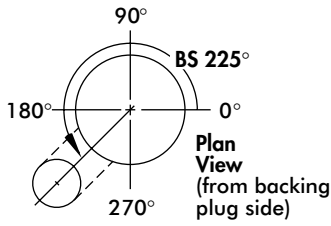

Hole Locations From Datum	
Dowel Holes	±0.01
Screw Holes	±0.13
Component Holes	±0.01

Specify radial location in degrees counter-clockwise from 0°.

Punch Shape	Ball Hole Class	Radial Tolerance
Round	B	±5°
Shape	BB	±0°5'

Note: Class B provided unless otherwise specified.

Space Requirements

Type	D	A	B	H
BRP	10	15	10	16
	13	17	12	19
	16	17	12	22
	20	17	12	26
	25	17	12	31
	32	17	12 <td 38	
CRP	40	17	12	46
	06	11.5	6	12
	10	13	8	16
	13	13	8	19
	16	13	8	22
	20	13	8	26
	25	13	8	31
	32	13	8	38
38	13	8	44	

Tighter spacing can be achieved. When two or more plugs interfere, flats will be ground on the Backing Plugs.

Alterations

Standard Jackscrew Hole

Jackscrews make it easier to pull retainers off the dowels.

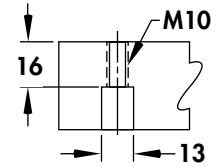

Special Size

Any amount of material can be removed from the sides of the retainer for a customer size. Edges are sawcut ±0.8

Clearance Holes

Clearance holes or tapped holes can be detailed or shown in the chart like the order example below.

Holes are drilled through the retainer unless otherwise specified.

Location ±0.3
Diameter +0.4
-0

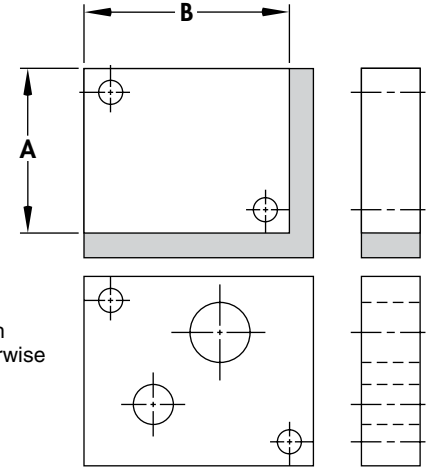

The following alterations require detail drawings.

Notches

Notches to clear other tooling can be added to any side of the retainer. Notches are sawcut ±0.8

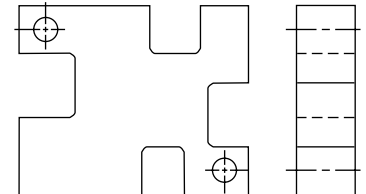

Angles

Angles, like notches can be added to clear other tooling in the die. Angles are sawcut ±0.8

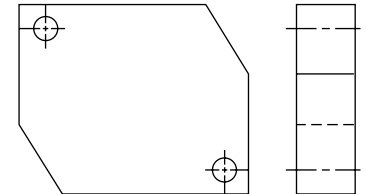

How to Order

Furnish the necessary information as indicated. Order forms for Multi-Position Retainers are available upon request.

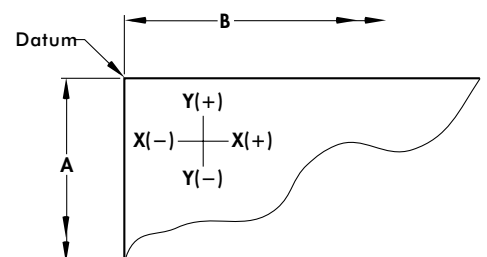

Retainer	Catalog No.	Special Size					
<input checked="" type="checkbox"/> BRP <input type="checkbox"/> CRP	70175	A _____	B _____				
Multi-Position™ Retainers							
Hole No.	Component Type	Component Size	Location X Axis	Location Y Axis	Ball Hole Location	Ball Hole Class	Backing Plug Type
1	DOWEL	10.0 S.F.	13.0	-13.0	—	—	—
2	S.H.C.S	M10	35.0	-13.0	—	—	—
3	BJR	16	53.0	-35.0	90°	BB	C
4	CLEAR	Ø33	108.0	-27.0	—	—	—
5	JACKSCR.	STD.	25.0	-25.0	—	—	—

S.F. = Slip Fit

You must specify all dimensions from datum.

EZ Fit™ Retainer Inserts

Dayton EZ Fit™ Ball Lock Retainer Inserts give you the ability to build, reconfigure, and custom-make retainers in-house as die specifications change. In addition, the unique single-piece teardrop shape, combined with both a straight and an angled wedge side, holds your ball lock punch securely in place.

EZ Fit™ reduces costs and downtime—and simplifies tooling changeover.

Mfg. under US Patent# 6,679,147

BRI Heavy Duty

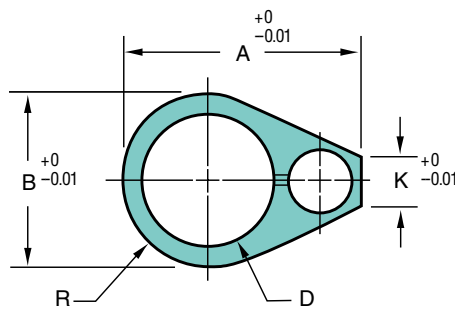

Ball hole location radial tolerance $\pm 0^{\circ}5'$

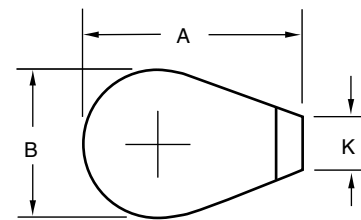
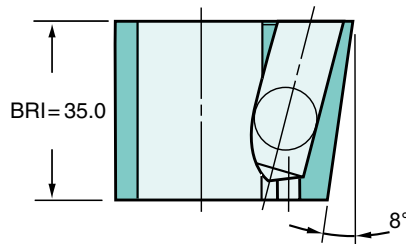

The shape shown above can be easily cut using wire EDM to assure a proper fit. The insert (utilizing both the straight and 8° angled sides) fits securely and is designed to clear the retainer by a small amount, making assembly and disassembly easier.















Each insert comes complete with wire cutting instructions that show recommended dimensions and tolerances for optimum performance. Wire cutting instructions are also available online at www.daytonprogress.com/EZFit

Type	Punch Hole Dia. D	Code	A	B	K
BRI	10	10	27.5	16.0	10.89
	13	13	33.0	19.5	12.26
	16	16	36.4	23.0	11.06
	20	20	40.7	27.5	9.88
	25	25	46.0	33.0	9.42
	32	32	53.2	40.0	8.92
	40	40	61.4	48.0	8.54

How to Order:

Qty. Catalog No.
5 **BRI 13**

Retainer Accessories

		Catalog Numbers/Sizes										
		BACKING PLUGS			Socket Head Cap Screw	Ball Release Screw	Dowel	Ball	Standard Spring	Extra Heavy Duty Spring	Booster Spring	Retainer Drill Bushing
		Single Hole Retainers		Multi-Position Retainers								
		Type A	Type B*	Type C								
												
		Standard	Optional	Standard								
Heavy Duty BRT  NRT 	10	268488	—	266086	574554 M8x45	268968 M4x12	260037 Ø6x20	268844 Ø12	268933	269034	269042	268372
	13	268534	—	266094								268399
	16	268542	—	266108								268402
	20	268569	—	266116	574597 M10x50							268429
	25	268577	—	266124	574694 M12x50							268437
	32	268585	—	266132								268445
	40	268593	—	—								—
Light Duty CRT  TRT 	10	268488	—	266086	574538 M8x35	268968 M4x12	260037 Ø6x20	268828 Ø8	268909	—	—	268372
	13	268534	266159	266094								268399
	16	268542	266167	266108								268402
	20	268569	266175	266116	574589 M10x40							268429
	25	268577	266183	266124	574635 M12x40							268437
	32	268585	266191	266132								268445
	38	268453	266205	—								—

*Clearance hole is 0.3 larger than the Max. R for Ball Lock CD_. See chart bottom of page 14, Standard Alterations.

The Key to Increased Productivity is Jektole Engineered Clearance **Jektole® Data**

Universal Jektole Components

EJECTOR PINS		J2M	J3M	J4M	J6M	J9M	J12M
Overall Length	L	28.0	35.0	49.4	49.0	56.5	56.5
Pin Diameter	D	0.43	0.68	1.04	1.47	2.26	3.05
Head Diameter	H	1.2	1.8	2.4	3.0	4.0	4.8
Head Thickness	T	0.8	1.2	1.6	1.6	2.4	2.4
SPRINGS		J2M	J3M	J4M	J6M	J9M	J12M
Outside Diameter	D	2.1	2.4	3.3	4.3	5.0	7.0
Free Length	L	60.3	60.3	81.0	76.2	68.9	65.1
SCREWS		J2M	J3M	J4M	J6M	J9M	J12M
Screw Size	D	M2.6	M3	M4	M5	M6	M8
Screw Length	L	5	5	5	5	6	6

Jektole Design Limits

DIMENSION	J2M	J3M	J4M	J6M	J9M	J12M
Min. Shank Dia. (Light)	D	6	6	10	13	20
Min. Shank Dia. (Heavy)	D	10	10	10	13	20
Min. Point Dia.	P	1.3	2.0	3.0	4.0	6.0
Max. Point Lgth.		32	38	41	41	41
Max. Shank Lgth.	S	87	87	84	84	70

Jektole® Components

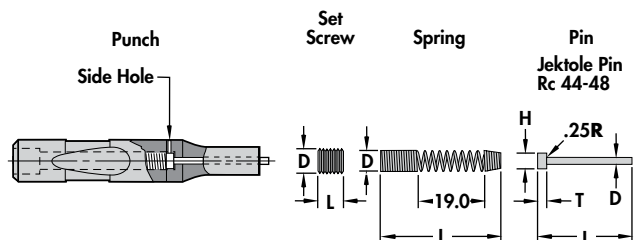

Punch Puller

Removes ball lock punches in three quick steps...

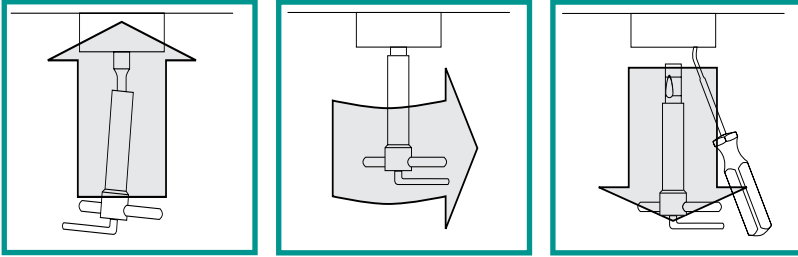

- 1** Slide Punch Puller over the shank.
- 2** Rotate the built-in wrench until tight.
- 3** Insert release tool and pull down.

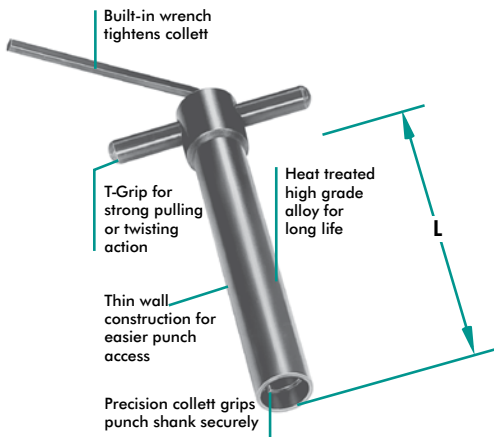

Remove and replace ball punches in minutes

Dayton Punch Pullers speed and simplify the task of removing ball lock punches from retainers. You no longer have to improvise with vise grips or other tools that can slip from the punch, making removal difficult and sometimes hazardous.

Made of high grade alloy steel, Dayton Punch Pullers are heat treated and precision machined for long, reliable service. Available in shank sizes from 06 to 32. Dayton Punch Pullers will save you time and money

Catalog Number	Shank Diameter	Max. Point Length	L Approx.
818402	06	28	95
818429	10	33	95
818437	13	40	100
818445	16	40	100
818453	20	40	100
818461	25	46	110
818488	32	46	110
818526		Set of 7	

Shim Plates

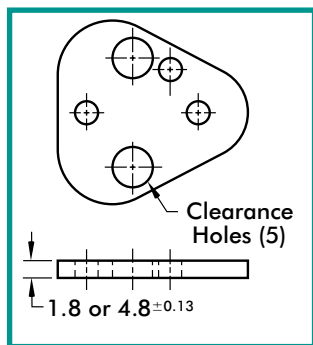

D	1.8 (Soft)	4.8 (Rc55)
10	URSP1018	URBP1048
13	URSP1318	URBP1348
16	URSP1618	URBP1648
20	URSP2018	URBP2048
25	URSP2518	URBP2548
32	URSP3218	URBP3248

Ball Release Tools

Angle Tip
(for all retainers) Cat. No. 818038



Straight Tip
(for all retainers) Cat. No. 818046



Threaded Tip
(for True Position® Retainers) Cat. No. 269999



Urethane Strippers

Strip-Shape Urethane Strippers assure positive stripping and they guard against punch failure by dampening punch vibration by gripping the punch point. The closed end design holds thin stock flat during the stripping cycle, reducing the potential of rejected parts.

Made from specially formulated urethane resins, these rugged strippers are guaranteed to meet your need for clean, fast, precise stripping action—with all types of punches. Because of Dayton's unique curing agent, Strip-Shape urethane provides greater load bearing capacity than ordinary urethanes. Lot-to-lot pressure ratings are also much more consistent.

Type
USM

Closed end conforms to punch shape

Air Hole

Push on

Punch shape in end of stripper.

Material can be pulled upward when using tube-type strippers.

Strip-Shape strippers hold stock flat.

Air Hole	I.D.
1.6	06-10
3.2	13-32

I.D.	O.D.	L	Catalog Number	Pressure at Deflection of		
				3.0	6.5	9.5
06	19	45	USM-06-45	1324	2256	—
		53	USM-06-53	1079	1863	2354
		71	USM-06-71	686	1079	1765
08	21	45	USM-08-45	1471	2207	—
		53	USM-08-53	1324	1961	2942
		71	USM-08-71	981	1618	2648
10	23	45	USM-10-45	1716	2795	—
		53	USM-10-53	1422	2452	3187
		56	USM-10-56	1422	2452	3187
13	26	45	USM-13-45	2109	3334	—
		53	USM-13-53	1471	2354	3432
		56	USM-13-56	1471	2354	2942
13	26	71	USM-13-71	1275	1961	2452

I.D.	O.D.	L	Catalog Number	Pressure at Deflection of		
				3.0	6.5	9.5
16	30	45	USM-16-45	2354	3825	—
		53	USM-16-53	2158	3531	4511
		56	USM-16-56	2158	3531	4511
		71	USM-16-71	1814	2942	3825
20	38	45	USM-20-45	2452	3923	—
		53	USM-20-53	2158	3629	5590
		71	USM-20-71	1618	2942	4658
25	50	45	USM-25-45	9317	14318	—
		53	USM-25-53	7355	11572	15985
		71	USM-25-71	4904	8336	13485

Urethane Hardness: 95 ± 5 Shore A
 Max. Recommended Deflection: 15% of Overall Length.
 (Pressure Ratings shown in Newtons)

How to Order:

Qty. Catalog No.
 10 **USM-08-71**

Urethane Stripping Units

Fits retainers with tapped dowel holes only, such as DAYTON retainers: ART, ARTS, BRT, CRT.

When using DAYTON Ball Lock retainers these strippers fit Light Duty punch lengths 71, 80, 90, 100 and Heavy Duty punch lengths 80, 90, 100, 110. On DAYTON Head Type retainers they fit punch lengths 71, 80, 90, 100.

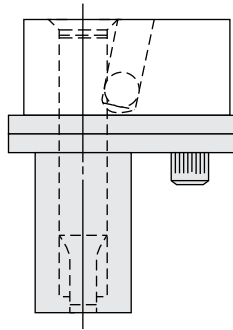

Catalog Number	D	L	Pressure at Deflection of		
			3	6	9
UHM10-43	10	43	1060	1820	—
UHM10-52		52	900	1650	2170
UHM10-63		63	720	1450	1860
UHM10-72		72	570	1280	1610
UHM13-43	13	43	1700	2850	—
UHM13-52		52	1460	2610	3410
UHM13-63		63	1170	2320	2910
UHM13-72		72	930	2080	2500
UHM16-43	16	43	2310	3900	—
UHM16-52		52	1990	3560	4640
UHM16-63		63	1590	3150	3980
UHM16-72		72	1270	2810	3440
UHM20-43	20	43	2900	4900	—
UHM20-52		52	2500	4470	5820
UHM20-63		63	2000	3950	5000
UHM20-72		72	1590	3420	4330
UHM25-43	25	43	4440	7520	—
UHM25-52		52	3810	6860	8780
UHM25-63		63	3050	6050	7680
UHM25-72		72	2420	5390	6780
UHM32-43	32	43	6840	11390	—
UHM32-52		52	5880	10450	13300
UHM32-63		63	4700	9310	11640
UHM32-72		72	3740	8370	10280
UHM38-52	38	52	9480	19330	29720
UHM38-72		72	5950	11630	18160
UHM40-43	40	43	10100	20190	—
UHM40-52		52	8650	17300	25960
UHM40-63		63	6890	13780	20670

Urethane Strippers UHM

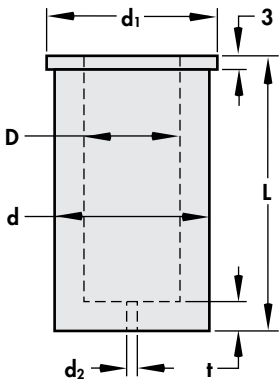

D	d	d ₁	t	d ₂
10	18	21	6	1.6
13	23	26	6	3.0
16	28	31	6	
20	33	36	7	
25	40	43	7	
32	50	55	7	3.0
38	60	65	8	
40	60	65	8	

Urethane Hardness: 95 ± 5 Shore A
 Max. Recommended Deflection: 15% of Overall Length.
 (Pressure Ratings shown in Newtons)

Backing Plates UBP

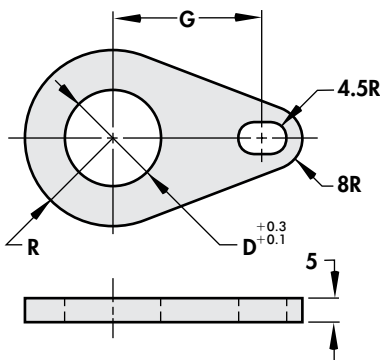

Retaining Plates URP

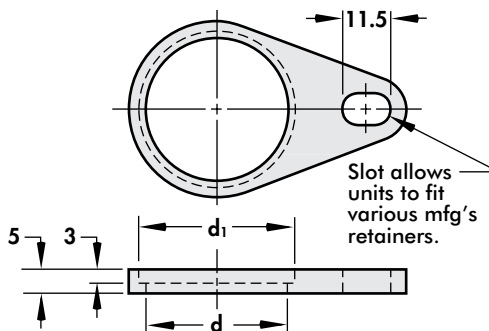

Catalog No.	Back Plate	Ret. Plate	D	d	d ₁	R	G	UBP, URB Set EDP No.
UBP10	URP10	10	19	22	13.0	28.0	748579	
UBP13	URP13	13	24	27	15.5	31.0	748587	
UBP16	URP16	16	29	32	18.0	32.9	748595	
UBP20	URP20	20	34	37	20.5	34.8	748609	
UBP25	URP25	25	41	44	24.0	39.8	748617	
UBP32	URP32	32	51	56	31.0	41.3	748625	
UBP38	URP38	38	61	66	36.0	45.0	748633	
UBP40	URP40	40	61	66	36.0	45.0	748641	

How to Order:

Qty. Catalog No.
 12 **UHM-16-63**
 12 **748595**

Set consists of: Backing Plate, Retaining Plate and M8 x 20 Socket Head Cap Screw.

Surface Treatments and Coatings

Some catalog products can be coated to increase hardness, reduce galling, and improve wear and/or corrosion resistance. These coatings and treatments are available for M2 and PS4 material.

Surface Treatments

DayKool™ (XCR)—A cryogenic steel conditioning process used in addition to heat treating. An effective way to achieve optimum toughness, improved strength, and dimensional stability. Used primarily with hard, thick materials.

DayTride® (XN)—A low temperature, cost-effective surface application that treats all exposed surfaces. Provides increased dimensional stability. Ideal for punches and die buttons. Approx. hardness: RC65-73.

XVP—A thin film coating provides superior hardness (harder than carbide). Super-smooth finish on the point helps reduce galling and maintenance. Ideal for higher-than-normal punching frequency.

XPS—Super-smooth polish on the point to reduce galling and improve punch life. Use with the appropriate coating for your application to maximize punch life and reduce maintenance costs. Excellent for extruding applications.

Abrasive Wear

DayTiN® (XNT)—Excellent wear resistance and lubricity. Not recommended for stainless steel, copper, or nickel. A good general-purpose coating. Approx. hardness: *Vickers 2300.

TiCN (XCN)—Ultra-hard (harder than carbide), thin coating. Provides superior abrasive wear resistance and lubricity. A very good general-purpose coating for all materials. Upgrade over XNT. Approx. hardness: *Vickers 3000.

DayTAN™ (XAN)—Ultra-hard (harder than carbide), high-aluminum coating. Provides high temperature resistance. Well-suited for applications where surface heat is generated. Ideal for HSLA, dual phase, and TRIP steels. Upgrade over XCN. Approx. hardness: *Vickers 3400.

ZertonPlus™ (XNA)—Superior hardness (harder than carbide); provides superior abrasive wear resistance and excellent lubricity. Provides highest temperature resistance, thermal shock stability, & hot hardness. Approx. hardness: *Vickers 3200.

Adhesive Wear

XNM—A solid lubricant coating. Provides both lubricity and wear resistance not available from other PVD or CVD processes. Ideal for aluminum, copper, pre-painted, and galvanized steels. Approx. hardness: *Vickers 2000.

XCD—Diamond-like carbon coating. Combines high hardness with an extremely low coefficient of friction. Good protection against abrasive and adhesive wear. Ideal for aluminum. Approx. hardness: *Vickers 5000.

XCDH—Super-smooth finish combined with advanced DLC coating for a very low coefficient of friction with extremely high wear resistance. Approx. hardness: *Vickers 5000.

XCDP—Super-smooth finish combined with a DLC coating for a very low coefficient of friction with high wear resistance. Excellent for stamping aluminum. Approx. Hardness: Vickers 2800.

Extrusion Coatings

XNP—The ultimate coating for improved resistance to galling; excellent wear resistance, superior surface finish, and high lubricity. Ideal for extruding and forming applications. Tolerance is $\pm .005$ mm. Approx. hardness: *Vickers 3100.

XNAProgress (XNAP)—Ultra-hard coating that absorbs shear stress; provides excellent high-temperature resistance. Ideal for stamping where tools are exposed to extreme stress profiles. A good alternative to TD coating without the dimensional changes associated with that process. Approx hardness: *Vickers 3200.

Miscellaneous Coating

CRN—Excellent adhesion, high toughness, and good corrosion resistance. Primary applications are metal forming (copper, brass, & bronze), metal die casting, and plastic injection molding. Approx. hardness: *Vickers 1800-2100.

* Vickers used when RC exceeds 80.

For Round Punches Only

XS19
Nail Point

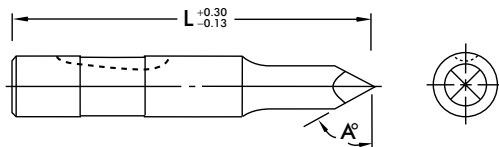

XS20
Chamfer

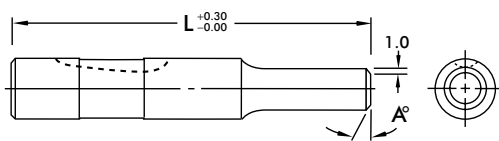

For Round & Shape Punches

Shown as reflected view.

XS21
Conical

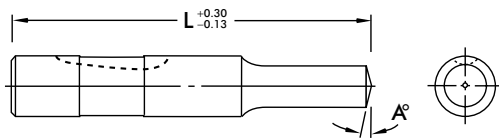

XS22
Double Shear

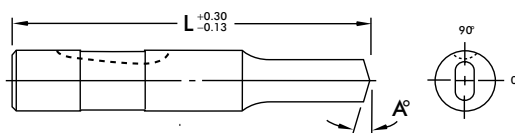

XS23
Single Shear

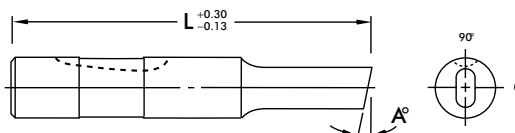

XS24
Single Shear
Angle with Flat

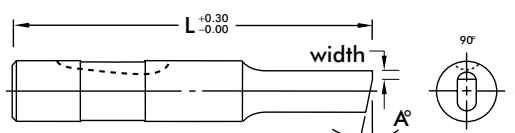

Shear Angles

Shear Angles can be applied to all punch points. These angles are used primarily to reduce slug pulling. Single and Double Shears can be used to reduce the punching force as well as minimize slug pulling. These alterations are prepriced and do not add to the standard delivery of the product.

Shear Angles are also available on Classified Shapes, but are available as special order only.

For your reference standard head flat and dowel locations are at 0°. For ball lock punches the standard ball seat location is at 90°.

Simply add the alteration code shown next to the drawings, and the angle desired, to your punch catalog number. Tolerance on all angles is ± 15 minutes.

How to Order:

Specify: Quantity
Product
Alteration

5 BJB 20 100 PS4 XS23 A3°

Commitment to Quality & Customer Satisfaction

Dayton Lamina is a leading manufacturer of tool, die and mold components for the metal-working and plastics industries. As a customer-focused, world-class supplier of choice, we provide the brands, product breadth, distribution network and technical support for all your metal forming needs.

Our goal is to give our customers the most innovative and value-added products and services.



DAYTON Lamina™

a MISUMI Group Company



IEM®



Lamina® LEMPCO

*Dayton Lamina's line of Danly products is available only to North America.

www.daytonlamina.com