

# ***Press Fit***

**Punches  
Die Buttons  
Pilots  
Retainers**

## **NEW**

- Punch Guides
- Alterations
- Straight Punches
- Clospace Punches
- Expanded Sizes
- PS Steel
- EDM Blanks
- Change Retainer

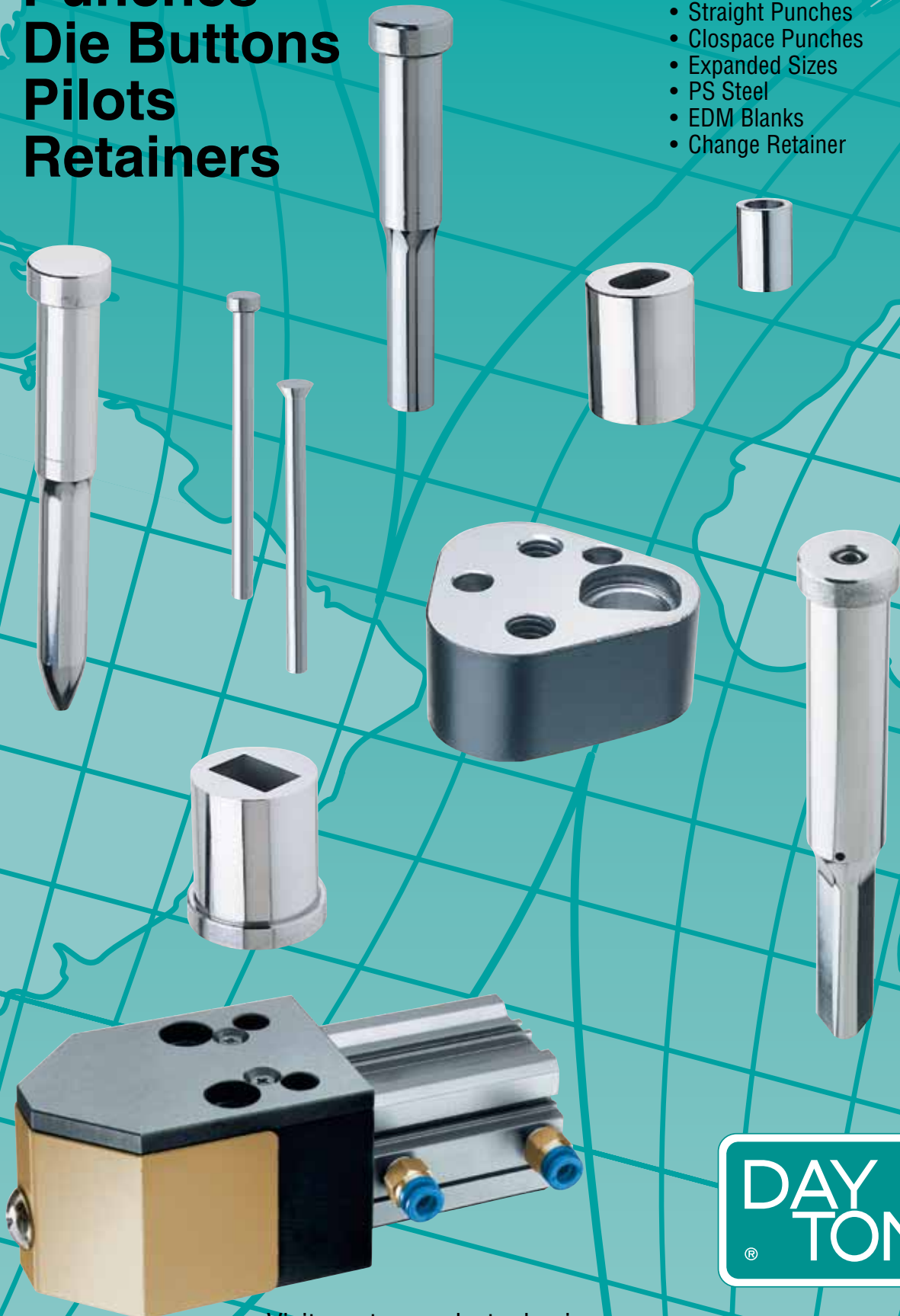

Visit us at [www.daytonlamina.com](http://www.daytonlamina.com)

# Press Fit Products

## Punches, Die Buttons, Pilots and Retainers

### Jektole® Punches and Clearances

Jektole, DAYTON's slug ejection punch, permits doubling punch to die button clearance, produces up to three times the number of hits between sharpenings and reduces burr heights.



### Dayton Slug Control Guaranteed to Stop Slug Pulling

Dayton Slug Control is a method of reducing the risk of slugs being pulled to the die surface during withdrawal of the punch. The slugs are trapped

in the land of the die buttons until they fall freely through the relief. It has no effect on hole size and will not require any changes in your regrind practices. Dayton Slug Control is effective throughout the life of the die buttons.

This innovative process uses a series of grooves inside the die button. The slug expands into the grooves, effectively trapping it. This unique method of controlling slugs is so dependable, it's guaranteed! Test it in your die and we will offer you this unconditional guarantee: **Use Dayton Slug Control in a stamping die now pulling slugs. If for any reason you are not completely satisfied, we will refund the full cost of the Slug Control alteration.** (We cannot guarantee the retention of slugs when clearance exceeds 10% per side.)



### Retainers for Single Head Type Punches

Instead of incorporating an expensive punch retainer in the die, use an inexpensive head type retainer. They save time and money. They are designed to the same exacting standards as Dayton's True Position retainers.



### Multiple Punch Retainers

When a cluster of holes is in an extremely tight area where single retainers will not fit, standard retainers with multiple holes are the answer. Dayton's **Multi-Location** retainers provide a simple low cost solution to multiple holes in a small area. They eliminate the need for special details, cutting both design and build time.

### Urethane Strippers

Urethane strippers that fit tightly over punches might be the answer to some of the low production jobs. Urethane can eliminate the costly stripper plate and provides a benefit over the bridge stripper normally used in low budget jobs. They hold the stock flat, unlike a bridge stripper, assuring the least amount of stripping pressure and resulting wear on punches.



# Table of Contents

## Punches

Standard Shapes

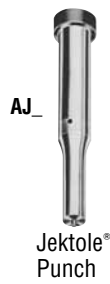
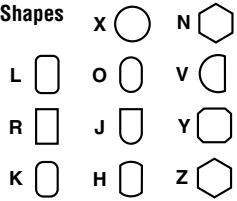

2



3

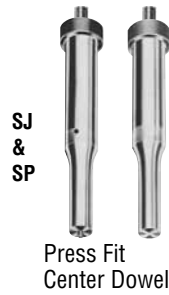

4-5



6

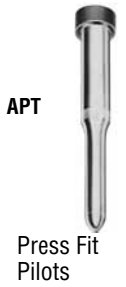

7

## Punches



8



8

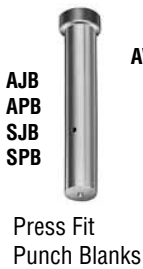

9

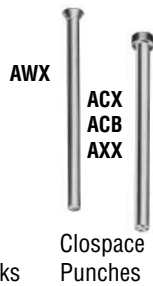

9

## Die Buttons

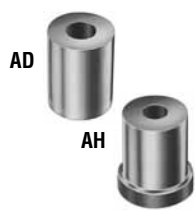

10-11



12



14

## Guide Bushings

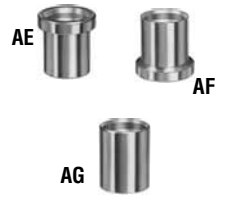

13

## Retainers



ARA & ARAS

Change Retainers

16

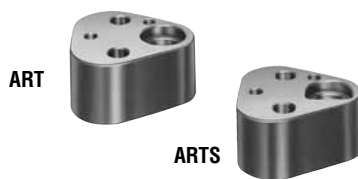

ART

ARTS

True-Location Headed Punch Retainers

17



ARP

Multi-Location Retainers

18-19

## Miscellaneous



Jektole Data

14



Shear Angles

15

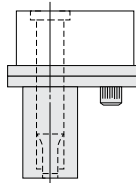

Urethane Strippers & Stripping Units

20-21

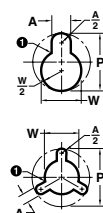

Classified Shapes

22-23

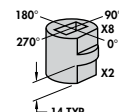

Locking Devices

24

Surface Treatments & Coatings

25

## Catalog Ordering System

The Catalog Designation completely defines the product, including shape, dimensions, tolerances and concentricity.

### How to Order

Specify Qty, Type, Catalog Number, and P or P & W Dimensions

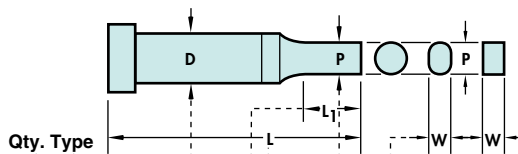

Example:

APR Line Product Shape

A for Press Fit  
P for Punch (Regular)  
R for Rectangle and Square

13 Shank Dia.

25 Point Length  $L_1$

80 Overall Length L

2 APR 13 25 80 P8.0 W6.5

APR 13 2580 P8.0, W6.5

All Trilateral Designators are a Trademark of Dayton Progress Corporation.

Type Catalog Number

Dimensions as Specified

# Jektole® Punches

ISO 8020 — Ejector Punches

Steel	HRC
A2, M2	60-63
PS	63-65

Heads Drawn to HRC 40-55 Through D25

Type **AJ\_**

**AJH** **AJK** **AJJ** **AJN** **AJV**

**AJX** **AJL** **AJO** **AJR** **AJY** **AJZ**

1 Sharp corners are typical. To assure proper clearance, Dayton will provide standard broken corners if the button is ordered with punch to eliminate interference with button fillet when total clearance is 0.08 or less.

2 Check your P&W dimensions to be sure the diagonal G does not exceed the max. shown.

$G = \sqrt{P^2 + W^2}$

No side hole D32

Shank D	Point Length L <sub>1</sub>		Type & D AJX	Range P	Type & D AJ_	Min. W	Max. P/G	L												Jektole Pin
	Std.	Alt.						40	50	56	60	63	70	71	80	90	100			
05	13	19	AJX 05	1.60– 4.95	AJ_05	1.60– 4.95		•	•	•	•	•	•	•	•	•	•	J2M		
06	13	19	AJX 06	2.40– 5.95	AJ_06	2.40– 5.95		•	•	•	•	•	•	•	•	•	•	J3M		
08	19	25	AJX 08	3.20– 7.95	AJ_08	3.20– 7.95			•	•	•	•	•	•	•	•	•	J4M		
10	19	25	AJX 10	4.50– 9.95	AJ_10	4.50– 9.95			•	•	•	•	•	•	•	•	•	J6M		
13	19	25	AJX 13	6.00–12.95	AJ_13	6.00–12.95			•	•	•	•	•	•	•	•	•	J6M		
16	19	25	AJX 16	8.00–15.95	AJ_16	7.20– 15.95			•	•	•	•	•	•	•	•	•	J9M		
20	19	25	AJX 20	10.00–19.95	AJ_20	8.00– 19.95			•	•	•	•	•	•	•	•	•	J9M		
25	19	25	AJX 25	12.00–24.95	AJ_25	9.00– 24.95			•	•	•	•	•	•	•	•	•	J9M		
32	25	30	AJX 32	16.00–31.95	AJ_32	10.00– 31.95						•	•	•	•	•	•	J12M		

Alternate point length not available

## A new shape for Longer Life

DAYTON'S new standard shape with a constant corner radius of 0.5R puts the clearance where it's needed to prevent rapid wear and unacceptable burrs commonly generated with sharp corners. This reduces maintenance time and the risk of edge breaking during operation.

The "L" Long Life punch will reduce maintenance costs while increasing production runs by reducing corner wear.

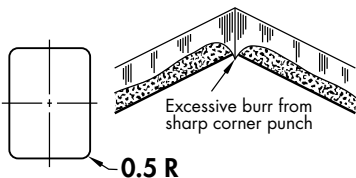

## Standard Alterations for AJ and AP Punches

Standard alterations are the ranges beyond those sizes listed above and can be manufactured for a slight additional charge. Some AP\_ products are available as standard below these ranges (see AP\_ chart).

**XP, XW** P & W Dimensions Smaller than Standard

**XBR** Point Length Longer than Standard

Specify XBR or XBB and length (see chart)

**XBB adds 3 days to delivery**

L <sub>1</sub> Max.	XBR							XBB	XBB							Jektole Pin	
	8	13	19	25	30	35	40		8	13	19	25	30	35	40		
D	Min. P (Rounds)								Min. W (Shapes)								
04	0.8	1.1	1.3	1.9	2.5	–	–	1.3	1.6	1.6	2.4	2.8	–	–	–	–	–
05	1.3	1.3	1.5	2.4	–	–	–	1.6	1.6	1.6	2.4	–	–	–	–	–	J2M
06	2.0	2.0	2.0	2.4	2.5	–	–	2.0	2.0	2.0	2.4	3.0	–	–	–	–	J3M
08	3.0	3.0	3.0	3.0	3.0	3.2	–	3.0	3.0	3.0	3.0	4.0	4.0	–	–	–	J4M
10	4.0	4.0	4.0	4.0	4.0	4.0	6.0	4.0	4.0	4.0	4.0	4.0	4.5	6.0	–	–	J6M
13	–	4.0	4.0	4.0	4.0	4.0	6.0	–	4.0	4.0	4.0	4.0	4.5	6.0	–	–	J6M
16	–	6.0	6.0	6.0	6.0	6.0	6.0	–	6.0	6.0	6.0	6.0	6.0	6.0	–	–	J9M
20	–	6.0	6.0	6.0	7.6	7.6	7.6	–	6.0	6.0	6.0	6.0	6.0	6.0	–	–	J9M
25	–	8.0	8.0	8.0	10.0	10.0	10.0	–	6.0	6.0	6.0	6.0	6.0	6.0	–	–	J9M
32	–	10.0	10.0	10.0	10.0	10.0	10.0	–	7.2	7.2	7.2	7.2	7.2	7.2	–	–	J12M

**A DAYTON Difference JEKTOLE**

The "Triple Your Production" Punch

Retractable Slug Ejector. See page 14.

Pat. No. 2,917,960 and 3,255,654

**XD** Reduced Shank Diameter

Head Diameter does not change with body diameter.

Shank Dia.	4	5	6	8	10	13	16	20	25	32
Min. XD	2.5	4.4	4.5	6.8	8.8	11.5	14.5	18.5	23.5	30.5

**XK** No Side Hole  
For air ejection. No cost.  
Components not supplied.

**XJ** Smaller Jektole Components

Steel	HRC
A2, M2	60-63
PS	63-65

Heads Drawn to HRC 40-55  
Through D25

# Regular Punches

ISO 8020 — Non-ejector Punches

Type  
**AP\_**

**APH**

**APK**

**APJ**

**APN**

**APV**

**APX**

**APL**

**APO**

**APR**

**APY**

**APZ**

1 Sharp corners are typical. To assure proper clearance, Dayton will provide standard broken corners if the button is ordered with punch to eliminate interference with button fillet when total clearance is 0.08 or less.

2 Check your P&W dimensions to be sure the diagonal G does not exceed the max. shown.

$$G = \sqrt{P^2 + W^2}$$

Shank D	Point Length L <sub>i</sub>		Type & D	Range	Type & D	Min. W	Max. P/G	L										
	Std.	Alt.						APX	P	AP_	40	50	56	60	63	70	71	80
04	8	13	APX 04	1.60– 3.95	AP_04	1.60– 3.95		•	•	•	•	•	•	•	•	•	•	•
05	13	19	APX 05	1.60– 4.95	AP_05	1.60– 4.95		•	•	•	•	•	•	•	•	•	•	•
06	13	19	APX 06	1.60– 5.95	AP_06	1.60– 5.95		•	•	•	•	•	•	•	•	•	•	•
08	19	25	APX 08	2.50– 7.95	AP_08	2.50– 7.95		•	•	•	•	•	•	•	•	•	•	•
10	19	25	APX 10	3.20– 9.95	AP_10	3.20– 9.95		•	•	•	•	•	•	•	•	•	•	•
13	19	25	APX 13	5.00–12.95	AP_13	4.50–12.95		•	•	•	•	•	•	•	•	•	•	•
16	19	25	APX 16	8.00–15.95	AP_16	6.00–15.95		•	•	•	•	•	•	•	•	•	•	•
20	19	25	APX 20	10.00–19.95	AP_20	8.00–19.95		•	•	•	•	•	•	•	•	•	•	•
25	19	25	APX 25	12.00–24.95	AP_25	9.00–24.95		•	•	•	•	•	•	•	•	•	•	•
32	25	30	APX 32	16.00–31.95	AP_32	10.00–31.95		•	•	•	•	•	•	•	•	•	•	•

Alternate point length not available

**XL Overall Length Shortened**  
(note limits under "XBR")  
Stock removal from point end which shortens L<sub>i</sub> length.

**XLB Overall Length Shortened**  
L<sub>i</sub> length maintained  
(note limits under "XBR")

**LL Precision Overall Length**  
Same as XL except overall length is held to ±0.02.

**XT Thinner Head than Standard**  
Stock removal from head end which shortens overall length.

**TT Precision Head Thickness**  
Same as XT except Head thickness tolerance is held to ±0.01.

**XH Reduced Head Diameter**  
Minimum head diameter equals D +0.00, -0.03.

**XLD Alternate Lead Length**  
The XLD alteration fixes the punch shank length at 40 measured from the punch head. This eliminates pressing the entire shank through the holder.

### How to Order

Specify: Quantity  
Type  
Shank Diameter  
Point & Overall Length  
P or P & W Dimensions  
Steel  
Standard Alterations

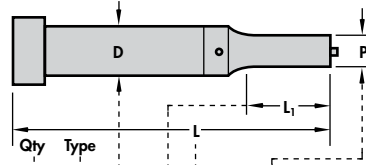

20 AJX 16 19 80 P8.3, A2  
49 AJR 16 25 80 P8.5, W8.0, A2, X2  
7 APL 16 19 71 P8.2, W7.2, M2, X2

See page 25 for coatings/treatments and shear angles.

### Key Flats

The standard location for a key flat is Parallel to the P dimension.  
See page 24 for additional Locking Devices.

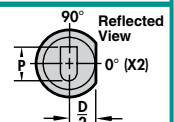

# Press Fit Center Dowel Punches

Steel	HRC
A2, M2	60-63

Heads Drawn to HRC 40-55  
Through D25

Jektol®

Type  
**SJ\_**

Shape

① Sharp corners are typical. To assure proper clearance, Dayton will provide standard broken corners if die button is ordered with punch to eliminate interference with button fillet when total clearance is 0.08 or less.

② Check your P&W dimensions to be sure the diagonal G does not exceed the max. shown.

$$G = \sqrt{P^2 + W^2}$$

Shank D	Point Length L <sub>1</sub>		Type & D SJX	Range P	Type & D SJ_	Min. W	Max. P/G	L							Jektol Pin	
	Std.	Alt.						71	80	90	100	110	120	130		
10	19	25	SJX 10	4.50- 9.95	SJ_ 10	4.50- 9.95		•	•	•	•	•	•	•	•	J6M
13	19	25	SJX 13	6.00-12.95	SJ_ 13	6.00- 12.95		•	•	•	•	•	•	•	•	J6M
16	19	25	SJX 16	8.00-15.95	SJ_ 16	7.20- 15.95		•	•	•	•	•	•	•	•	J9M
20	19	25	SJX 20	10.00-19.95	SJ_ 20	8.00- 19.95		•	•	•	•	•	•	•	•	J9M
25	19	25	SJX 25	12.00-24.95	SJ_ 25	9.00- 24.95		•	•	•	•	•	•	•	•	J9M
32	25	30	SJX 32	16.00-31.95	SJ_ 32	10.00- 31.95		•	•	•	•	•	•	•	•	J9M

Tapped Dowel Ø6 x 25 Included

## A new shape for Longer Life

DAYTON'S new standard shape with a constant corner radius of 0.5R puts the clearance where it's needed to prevent rapid wear and unacceptable burrs commonly generated with sharp corners. This reduces maintenance time and the risk of edge breaking during operation. The "L" Long Life punch will reduce maintenance costs while increasing production runs by reducing corner wear.

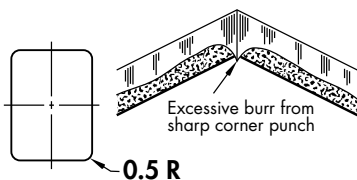

## Standard Alterations for SJ and SP Punches

Standard alterations are the ranges beyond those sizes listed in the catalog which can be manufactured for a slight additional charge.

### XP, XW P & W Dimensions Smaller than Standard

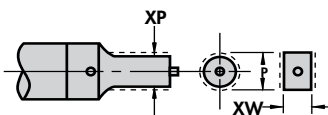

### XBR Point Length Longer than Standard

Specify XBR or XBB and length (see chart)

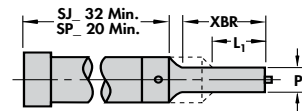

L <sub>1</sub> Max. D	XBR						XBB	XBR						XBB	Jektol Pin
	8	13	19	25	30	35		8	13	19	25	30	35		
	Min. P (Rounds)														
	Min. W (Shapes)														
10	4.0	4.0	4.0	4.0	4.0	4.0	6.0	4.0	4.0	4.0	4.0	4.0	4.5	6.0	J6M
13	-	4.0	4.0	4.0	4.0	4.0	6.0	-	4.0	4.0	4.0	4.0	4.5	6.0	J6M
16	-	6.0	6.0	6.0	6.0	6.0	6.0	-	6.0	6.0	6.0	6.0	6.0	6.0	J9M
20	-	6.0	6.0	6.0	7.6	7.6	7.6	-	6.0	6.0	6.0	6.0	6.0	6.0	J9M
25	-	8.0	8.0	8.0	10.0	10.0	10.0	-	6.0	6.0	6.0	6.0	6.0	6.0	J9M
32	-	10.0	10.0	10.0	10.0	10.0	10.0	-	7.2	7.2	7.2	7.2	7.2	7.2	J9M

XBB adds 3 days to delivery

### XD Reduced Shank Diameter

Head Diameter does not change with body diameter.

Shank Dia.	10	13	16	20	25	32
Min. XD	-	11.5	14.5	18.5	23.5	30.5

**XK** No Side Hole  
For air ejection. No cost.  
Components not supplied.

**XJ** Smaller Jektol Components

### A DAYTON Difference JEKTOLE

The "Triple Your Production" Punch



Retractable Slug Ejector. See page 14.

Pat. No. 2,917,960 and 3,255,654



Steel	HRC
A2, M2	60-63

Heads Drawn to HRC 40-55  
Through D25

# Press Fit Center Dowel Punches

Regular

Type  
**SP\_**

Shape

SPH SPK SPJ SPN SPV  
SPX SPL SPO SPR SPY SPZ

① Sharp corners are typical. To assure proper clearance, Dayton will provide standard broken corners if die button is ordered with punch to eliminate interference with button fillet when total clearance is 0.08 or less.

② Check your P&W dimensions to be sure the diagonal G does not exceed the max. shown.

$$G = \sqrt{P^2 + W^2}$$

Shank D	Point Length L <sub>1</sub>		Type & D SPX	Range P	Type & D SP_	Min. W	Max. P/G	L								
	Std.	Alt.						71	80	90	100	110	120	130	140	150
10	19	25	SPX 10	4.50– 9.95	SP_ 10	4.50– 9.95		•	•	•	•	•	•			
13	19	25	SPX 13	6.00–12.95	SP_ 13	6.00–12.95		•	•	•	•	•	•	•		
16	19	25	SPX 16	8.00–15.95	SP_ 16	7.20–15.95		•	•	•	•	•	•	•	•	
20	19	25	SPX 20	10.00–19.95	SP_ 20	8.00–19.95		•	•	•	•	•	•	•	•	•
25	19	25	SPX 25	12.00–24.95	SP_ 25	9.00–24.95		•	•	•	•	•	•	•	•	•
32	25	30	SPX 32	16.00–31.95	SP_ 32	10.00–31.95		•	•	•	•	•	•	•	•	•

Tapped Dowel Ø6 x 25 Included

**XL** Overall Length Shortened  
(note limits under "XBR")  
Stock removal from point end which shortens L<sub>1</sub> length.

**XLB** Overall Length Shortened  
L<sub>1</sub> length maintained  
(note limits under "XBR")

**LL** Precision Overall Length  
Same as XL except overall length is held to ±0.02.

**XT** Thinner Head than Standard  
Stock removal from head end which shortens overall length.

**TT** Precision Head Thickness  
Same as XT except Head thickness tolerance is held to ±0.01.

**XH** Reduced Head Diameter  
Minimum head diameter equals D + 0.00, - 0.03.

**XLD** Alternate Lead Length  
The XLD alteration fixes the punch shank length at 40 measured from the punch head. This eliminates pressing the entire shank through the holder.

## How to Order

Specify: Quantity  
Type  
Shank Diameter  
Point & Overall Length  
P or P & W Dimensions  
Steel  
Standard Alterations

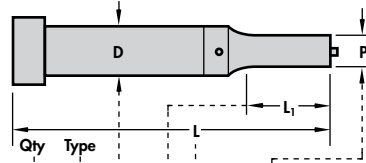

20 SJX 16 19 80 P8.3, M2  
49 SJR 16 25 80 P8.5, W8.0, A2, X2  
7 SPL 16 19 71 P8.2, W7.9, M2, X2

See page 25 for coatings/treatments and shear angles.

## Key Flats

The standard location for a key flat is Parallel to the P dimension.  
See page 24 for additional Locking Devices.

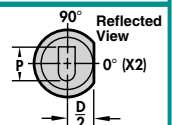

# Press Fit Positive Pick-Up Pilots

Steel	HRC
M2	60-63

Heads Drawn to HRC 40-55  
Through D25

Order any length from 65 through 142MM.

Type  
**APA Regular**  
**SPA Center Dowel**

When P = D shank tolerance applies to full length.

Shank D	Point Length L <sub>1</sub>		Type & D APA/SPA	Range P	Nose Lgth. N	L								
	Std.	Alt.				65	72	73	82	92	102	112	127	142
10	21	27	APA/SPA 10	4.85-10.00	8	•	•	•	•	•	•	•		
13	21	27	APA/SPA 13	6.30-13.00	10	•	•	•	•	•	•	•		
16	21	27	APA/SPA 16	9.95-16.00	15		•	•	•	•	•	•	•	•
20	21	27	APA/SPA 20	13.60-20.00	20		•	•	•	•	•	•	•	•
25	21	27	APA/SPA 25	17.25-25.00	25		•	•	•	•	•	•	•	•
32	27	32	APA/SPA 32	20.85-32.00	30		•	•	•	•	•	•	•	•

Tapped Dowel Ø6 x 25 included for SPA

## Standard Alterations for APA, SPA, APT Pilots

Standard alterations are the ranges beyond those sizes listed in the catalog which can be manufactured for a slight additional charge.

### XBR Point Length Longer than Standard

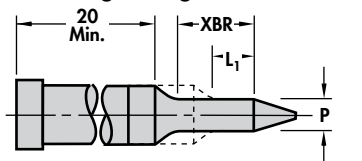

XBB and X3B adds 3 days to delivery

L <sub>1</sub> Max	APA/SPA APT	XBR								
		15	21	27	32	37	42	50	60	70
D		Minimum P								
04		1.55	1.55	1.85	2.45	—	—	—	—	—
05		1.55	1.55	1.85	2.45	—	—	—	—	—
06		1.55	1.55	1.95	2.45	2.95	—	—	—	—
08		1.55	1.55	2.35	2.45	3.15	5.95	—	—	—
10		1.55	1.55	2.45	3.15	3.15	5.95	5.95	5.95	7.95
13		3.15	3.15	3.15	3.15	3.95	5.95	5.95	5.95	7.95
16		5.95	5.95	5.95	5.95	5.95	5.95	5.95	5.95	7.95
20		5.95	5.95	5.95	7.55	7.55	7.55	7.55	7.55	7.95
25		7.95	7.95	7.95	9.95	9.95	9.95	9.95	9.95	9.95
32		9.95	9.95	9.95	9.95	9.95	9.95	9.95	9.95	9.95

Shaded Area for APA/SPA-Only

### XP P Smaller than Standard

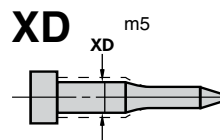
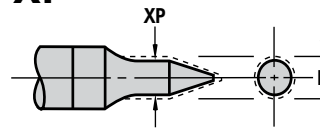

**Reduced Shank Diameter**  
Head Diameter does not change with body diameter.

Shank Dia.	5	6	8	10	13	16	20	25	32
Min. XD	3.5	4.5	6.5	8.5*	11.5	14.5	18.5	23.5	30.5

\*Not available on SPA



Steel	HRC
A2, M2	60-63
PS	63-65

Heads Drawn to HRC 40-55  
Through D25

# Press Fit Pilots

ISO 8020

Type  
**APT**

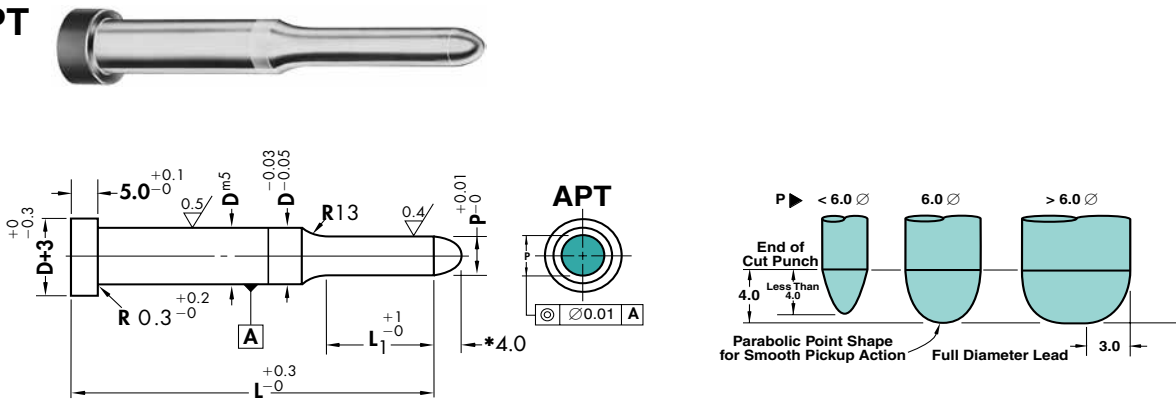

The drawing shows a side view and a cross-section of the APT pilot. Key dimensions include: Shank diameter  $D \pm 0.03$ , Point length  $L_1 \pm 0.1$ , Head diameter  $D \pm 0.03$ , Head radius  $R13$ , and Head thickness  $P \pm 0.01$ . A detail view shows a parabolic point shape with a lead of 3.0. The diagram also shows three variations of the point shape based on the range  $P$ :  $P < 6.0 \varnothing$ ,  $6.0 \varnothing$ , and  $P > 6.0 \varnothing$ . The end of the cut punch is 4.0 units from the tip, with a lead of less than 4.0. The full diameter lead is 3.0 units.

\*Length slightly less for under 6.0  $\varnothing$

When  $P = D$  shank tolerance applies to full length.

Shank D	Point Length $L_1$		Type & D APT	Range P	L									
	Std.	Alt.			42	52	58	62	65	72	73	82	92	102
04	10	15	APT 04	1.55- 4.00	•	•	•	•	•	•	•	•	•	•
05	15	21	APT 05	1.55- 5.00	•	•	•	•	•	•	•	•	•	•
06	15	21	APT 06	1.55- 6.00	•	•	•	•	•	•	•	•	•	•
08	21	27	APT 08	2.45- 8.00		•	•	•	•	•	•	•	•	•
10	21	27	APT 10	3.15-10.00		•	•	•	•	•	•	•	•	•
13	21	27	APT 13	4.95-13.00		•	•	•	•	•	•	•	•	•
16	21	27	APT 16	7.95-16.00		•	•	•	•	•	•	•	•	•
20	21	27	APT 20	9.95-20.00			•	•	•	•	•	•	•	•
25	21	27	APT 25	11.95-25.00				•	•	•	•	•	•	•
32	27	32	APT 32	15.95-32.00						•	•	•	•	•

Alternate point length not available

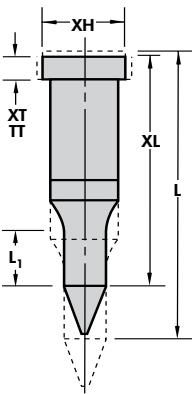

**XL Overall Length Shortened**  
(note limits under "XBR")  
Stock removal from point end –  $L_1$  maintained APA & SPA only.

**XLB Overall Length Shortened**  
 $L_1$  length maintained  
(note limits under "XBR")  
(APT only)

**XT Thinner Head than Standard**  
Stock removal from head end which shortens overall length.

**TT Precision Head Thickness**  
Same as XT except Head thickness tolerance is held to  $\pm 0.01$ .

**XH Reduced Head Diameter**  
Minimum head diameter equals  $D + 0.00, - 0.03$ .

**XLD Alternate Lead Length**  
The XLD alteration fixes the punch shank length at 40 measured from the punch head. This eliminates pressing the entire shank through the holder. Standard on APA, SPA.

## How to Order

Specify: Quantity  
Type  
Shank Diameter  
Point & Overall Length  
P or P & W Dimensions  
Steel  
Standard Alterations

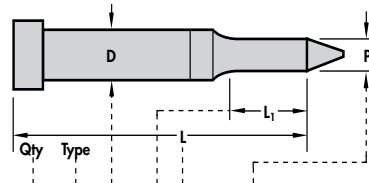

6 APA 13 27 112 P12.90, M2, XL = 105  
4 APT 16 21 82 P8.70, M2

See page 25 for coatings/treatments and shear angles.

# Extended Range Punches

Steel	HRC
A2, M2	60-63

Jektole® & Regular For Larger Dia. Holes

Type  
**AJ**\_\_\_\_\_



Type  
**AP**\_\_\_\_\_



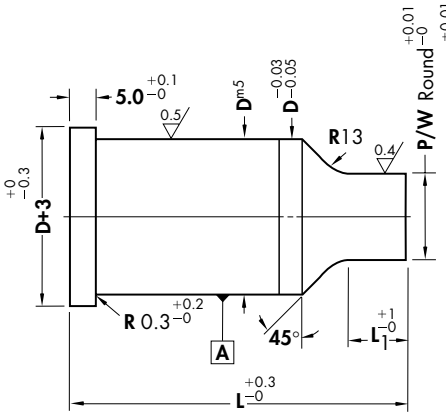

When D minus P or W exceeds 10 a step will exist.

**A\_H**

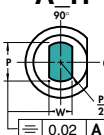

**A\_K**

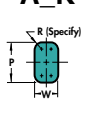

**A\_J**

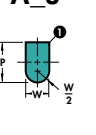

**A\_N**

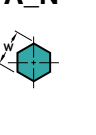

**A\_V**



**A\_X**

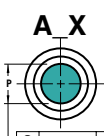

**A\_O**

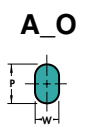

**A\_R**

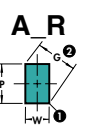

**A\_Y**

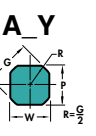

**A\_Z**



① Sharp corners are typical. To assure proper clearance, Dayton will provide standard broken corners to eliminate interference with die button fillet when total clearance is 0.08 or less.

② Check your P&W dimensions to be sure the diagonal G does not exceed the max. shown.

$$G = \sqrt{P^2 + W^2}$$

Type	Shank D	Point Length L <sub>1</sub>		Round Range P	Shape Min. W Max. P/G	L					
		Std.	Alt.			63	70	71	80	90	100
<b>AJ</b> <b>AP</b> _____	40.0	25	30	20.0-39.95	8.0-39.95	•	•	•	•	•	•
	45.0	25	30	25.0-44.95	9.0-44.95	•	•	•	•	•	•
	50.0	25	30	30.0-49.95	10.0-49.95	•	•	•	•	•	•
	56.0	25	30	35.0-55.95	11.0-55.95	•	•	•	•	•	•
	63.0	25	30	40.0-62.95	12.0-62.95	•	•	•	•	•	•

Alternate point lengths not available

### How to Order

Specify: Quantity  
Type  
Shank Diameter  
Point & Overall Length  
P or P & W Dimensions  
Steel

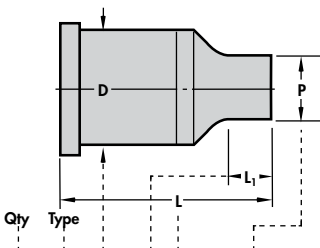

3 APR50- 30 100 P36.5, W15.5, X2

## Straight Punches

Steel	HRC
A2, M2	60-63

All Heads Drawn to HRC 40-55

Type  
**AYX & AUX**



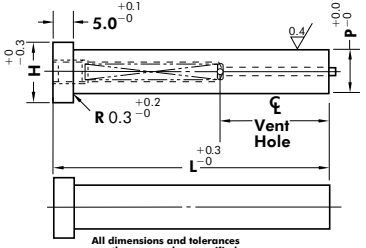

All dimensions and tolerances are the same unless specified.

**AYX**



**AUX**



## Key Flats

The standard location for a key flat is Parallel to the P dimension. See page 24 for additional Locking Devices.

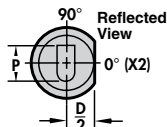

### How To Order

#### Straight Punches, Blanks, Clospace Punches

Qty	Type	L	P	Qty	Type	D	L
18	AUX	63	P7.0, A2	10	ACX	06	80, M2
10	AWX	71	P2.5, M2	5	APB	13	71, M2
25	AXX	80	P3.5, M2				

Type	Range P	H	Vent Hole	L						Jektole Pin		
				50	56	60	63	70	71		80	90
<b>AYX</b>	5.00- 6.00	9.0	14.0	•	•							J2M
	6.01- 8.00	11.0	21.3	•	•	•	•	•	•	•	•	J3M
	8.01-10.00	13.0	22.5	•	•	•	•	•	•	•	•	J4M
	10.01-13.00	16.0	22.5	•	•							J6M
	13.01-16.00	19.0	27.9	•	•							J9M
<b>AUX</b>	3.00- 4.00	7.0		•	•	•	•	•	•	•	•	
	4.01- 5.00	8.0		•	•	•	•	•	•	•	•	
	5.01- 6.00	9.0		•	•	•	•	•	•	•	•	
	6.01- 8.00	11.0		•	•	•	•	•	•	•	•	
	8.01-10.00	13.0		•	•	•	•	•	•	•	•	
	10.01-13.00	16.0		•	•	•	•	•	•	•	•	
	13.01-16.00	19.0		•	•	•	•	•	•	•	•	

Steel	HRC
A2, M2 (all blanks)	60-63
PS (AJB, APB)	63-65

# Press Fit Punch Blanks

ISO 8020

Heads Drawn to HRC 40-55  
Through D25

Type  
**AJB/SJB Jektole**  
**APB/SPB Regular**

SJB & SPB are Center Dowel Punch Blanks.

Tapped Dowel Ø6x25 Included

All dimensions and tolerances are the same unless specified.

Shank D	Type	L										Jektole Pin	
		40	50	56	60	63	70	71	80	90	100		
04	APB	•	•	•	•	•	•	•	•	•	•	•	—
05	AJB/APB	•	•	•	•	•	•	•	•	•	•	•	J2M
06	AJB/APB	•	•	•	•	•	•	•	•	•	•	•	J3M
08	AJB/APB	•	•	•	•	•	•	•	•	•	•	•	J4M
10	AJB/APB	•	•	•	•	•	•	•	•	•	•	•	J6M
13	AJB/APB	•	•	•	•	•	•	•	•	•	•	•	J6M
16	AJB/APB	•	•	•	•	•	•	•	•	•	•	•	J9M
20	AJB/APB	•	•	•	•	•	•	•	•	•	•	•	J9M
25	AJB/APB	•	•	•	•	•	•	•	•	•	•	•	J9M
32	AJB/APB	•	•	•	•	•	•	•	•	•	•	•	J12M*

Shank D	Type	L										Jektole Pin	
		71	80	90	100	110	120	130	140	150			
10	SJB/SPB	•	•	•	•	•	•	•	•	•	•	•	J6M
13	SJB/SPB	•	•	•	•	•	•	•	•	•	•	•	J6M
16	SJB/SPB	•	•	•	•	•	•	•	•	•	•	•	SPB SPB J9M
20	SJB/SPB	•	•	•	•	•	•	•	•	•	•	•	SPB SPB J9M
25	SJB/SPB	•	•	•	•	•	•	•	•	•	•	•	SPB SPB J9M
32	SJB/SPB	•	•	•	•	•	•	•	•	•	•	•	SPB SPB J12M*

Jektole Side-hole position allows room for alternate point lengths shown on pages 2 & 4.

\*J9M for SJB

\*\*Not available for AJB

# CloSPACE Punches

Steel	HRC
A2, M2	60-63

Heads Drawn to HRC 40-55 (except AWX)

Type  
**AWX**  
(M2 only)

Type  
**AXX**

Pointed Punches  
Type  
**ACX**  
A2, M2

Punch Blanks  
Type  
**ACB**  
A2, M2

All dimensions and tolerances are the same unless specified.

Range P	L										AXX H	
	40	45	50	56	60	63	70	71	80	90		100
0.800-1.275	•	•	•	•	•	•	•	•	•	•	•	3
1.276-1.600	•	•	•	•	•	•	•	•	•	•	•	3
1.610-2.000	•	•	•	•	•	•	•	•	•	•	•	4
2.010-3.000	•	•	•	•	•	•	•	•	•	•	•	5
3.010-4.000	•	•	•	•	•	•	•	•	•	•	•	6
4.010-5.000	•	•	•	•	•	•	•	•	•	•	•	7
5.010-6.000	•	•	•	•	•	•	•	•	•	•	•	8
6.010-7.000	•	•	•	•	•	•	•	•	•	•	•	9

Type	Body D	Head Dia. H	Point Length L <sub>1</sub>	ACX Range P	L												
					40	45	50	56	60	63	70	71	80	90	100		
<b>ACX</b> <b>ACB</b>	2.0	4.0	5.0	0.81-2.00	•	•	•	•	•	•	•	•	•	•	•	•	•
	3.0	5.0	7.0	2.01-3.00	•	•	•	•	•	•	•	•	•	•	•	•	•
	4.0	6.0	8.0	3.01-4.00	•	•	•	•	•	•	•	•	•	•	•	•	•
	5.0	7.0	8.0	4.01-5.00	•	•	•	•	•	•	•	•	•	•	•	•	•
	6.0	8.0	8.0	5.01-6.00	•	•	•	•	•	•	•	•	•	•	•	•	•
	7.0	9.0	8.0	6.01-7.00	•	•	•	•	•	•	•	•	•	•	•	•	•

# Die Buttons

Steel	HRC
A2, M2	60-63

## Headless/Headed — ISO 8977 (Round Only)

Type **AD\_**  
Headless

Type **AH\_**  
Headed

Check your P&W dimensions to be sure the diagonal G does not exceed the max. shown.  
 $G = \sqrt{P^2 + W^2}$

Body D	B			Type & D	Round Range P	Type & D	Shape		R	L							
	Std. S	Alt. A	Alt. B				Min. W	Max. P/G		20	22	25	28	30	32	35	40
08	4	—	—	A_X08	1.50- 2.40	—	—	—	3.5	•	•	•	•	•	•	•	•
	4	—	—	A_X08	2.41- 3.00	—	—	—	4.0	•	•	•	•	•	•	•	•
	4	8	—	A_X08	3.01- 3.20	—	—	—	4.0	•	•	•	•	•	•	•	•
10	4	—	—	A_X10	1.50- 2.40	A_10	—	—	3.5	•	•	•	•	•	•	•	•
	4	—	—	A_X10	2.41- 3.00	A_10	—	—	4.0	•	•	•	•	•	•	•	•
	4	8	—	A_X10	3.01- 3.20	A_10	1.20- 3.20	—	4.0	•	•	•	•	•	•	•	•
	4	8	—	A_X10	3.21- 5.00	A_10	1.20- 5.00	—	6.0	•	•	•	•	•	•	•	•
13	5	—	—	A_X13	1.50- 2.40	A_13	—	—	3.5	•	•	•	•	•	•	•	•
	5	—	—	A_X13	2.41- 3.00	A_13	—	—	4.0	•	•	•	•	•	•	•	•
	5	8	—	A_X13	3.01- 3.20	A_13	—	—	4.0	•	•	•	•	•	•	•	•
	5	8	—	A_X13	3.21- 5.00	A_13	2.00- 5.00	—	6.0	•	•	•	•	•	•	•	•
	5	8	—	A_X13	5.01- 7.20	A_13	2.00- 7.20	—	8.0	•	•	•	•	•	•	•	•
16	5	8	—	A_X16	5.00- 7.20	A_16	2.40- 7.20	—	8.0	•	•	•	•	•	•	•	•
	5	8	—	A_X16	7.21- 8.80	A_16	2.40- 8.80	—	9.5	•	•	•	•	•	•	•	•
20	5	12	20	A_X20	7.00- 8.80	A_20	3.20- 8.80	—	9.5	•	•	•	•	•	•	•	•
	5	12	20	A_X20	8.81-11.00	A_20	3.20-11.00	—	12.0	•	•	•	•	•	•	•	•
22	6	12	20	A_X22	9.00-14.00	A_22	4.00-14.00	—	15.0	•	•	•	•	•	•	•	•
25	6	12	20	A_X25	11.00-14.00	A_25	4.80-14.00	—	15.0	•	•	•	•	•	•	•	•
	6	12	20	A_X25	14.01-16.50	A_25	4.80-16.50	—	17.5	•	•	•	•	•	•	•	•
32	6	12	20	A_X32	13.00-16.50	A_32	5.50-16.50	—	17.5	•	•	•	•	•	•	•	•
	6	12	20	A_X32	16.51-20.00	A_32	5.50-20.00	—	21.0	•	•	•	•	•	•	•	•
38	8	12	20	A_X38	16.00-20.00	A_38	6.40-20.00	—	21.0	•	•	•	•	•	•	•	•
	8	12	20	A_X38	20.01-26.00	A_38	6.40-26.00	—	27.0	•	•	•	•	•	•	•	•
40	8	12	20	A_X40	16.00-20.00	A_40	6.40-20.00	—	21.0	•	•	•	•	•	•	•	•
	8	12	20	A_X40	20.01-26.00	A_40	6.40-26.00	—	27.0	•	•	•	•	•	•	•	•

### Standard Alterations for AD, AH Die Buttons

Standard Alterations are beyond those sizes listed above and can be manufactured for a slight additional charge.

AD, AH					AD only				
D	Min. P	Min. W	Max. P/G	R	D	Min. P	Min. W	Max. P/G	R
10	1.5*	1.2	5.5	6.0	45	16.0	6.4	35.0	36.0
13	1.5*	1.2	7.5	8.0	50	19.0	8.0	40.0	41.0
16	3.0	2.0	9.0	9.5	56	22.0	9.0	45.0	46.0
20	5.0	2.4	11.5	12.0	63	25.0	10.0	50.0	51.0
22	7.0	3.2	14.5	15.0	71	28.0	11.0	56.0	57.0
25	9.0	4.0	17.0	17.5	76	31.0	12.0	60.0	61.0
32	11.0	4.8	20.5	21.0	85	39.0	15.0	66.0	67.0
38	13.0	5.5	26.5	27.0	90	43.0	21.0	70.0	71.0
40	13.0	5.5	26.5	27.0	100	45.0	25.0	78.0	79.0

\*3.00 min. P at 8mm Land Length

### XP, XW P or W Dimensions Larger or Smaller than Standard

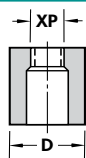

**XL Overall-Length Shortened**  
On AH\_ material is removed from top. Shortens B length. Minimum overall length = 6.35

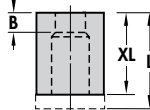

**LL Precision Overall-Length**  
Same as XL except overall length is held to ±0.02.

**XT Thinner Head than Standard**  
Stock removal from Head end which shortens overall length.

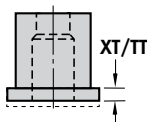

**TT Precision Head Thickness**  
Same as XT except head thickness is held to ±0.01.

Body D	Std. S	B		Type & D	Round Range P	Type & D	Shape		R	L							
		Alt. A	Alt. B				Min. W	Max. P/G		22	25	28	30	32	35	40	45
45	8	12	20	A_X45	19.00-26.00	A_45	8.00-26.00	27.0	.	.	.	.	.	.	.	.	.
	8	12	20	A_X45	26.01-35.00	A_45	8.00-35.00	36.0	.	.	.	.	.	.	.	.	.
50	8	12	20	A_X50	22.00-26.00	A_50	—	27.0	.	.	.	.	.	.	.	.	.
	8	12	20	A_X50	26.01-35.00	A_50	9.00-35.00	36.0	.	.	.	.	.	.	.	.	.
	8	12	20	A_X50	35.01-40.00	A_50	9.00-40.00	41.0	.	.	.	.	.	.	.	.	.
56	8	12	20	A_X56	25.00-35.00	A_56	10.00-35.00	36.0	.	.	.	.	.	.	.	.	.
	8	12	20	A_X56	35.01-40.00	A_56	10.00-40.00	41.0	.	.	.	.	.	.	.	.	.
	8	12	20	A_X56	40.01-45.00	A_56	10.00-45.00	46.0	.	.	.	.	.	.	.	.	.
63	8	12	20	A_X63	28.00-35.00	A_63	—	36.0	.	.	.	.	.	.	.	.	.
	8	12	20	A_X63	35.01-40.00	A_63	11.00-40.00	41.0	.	.	.	.	.	.	.	.	.
	8	12	20	A_X63	40.01-45.00	A_63	11.00-45.00	46.0	.	.	.	.	.	.	.	.	.
	8	12	20	A_X63	45.01-50.00	A_63	11.00-50.00	51.0	.	.	.	.	.	.	.	.	.
71	8	12	20	A_X71	31.00-40.00	A_71	12.00-40.00	41.0	.	.	.	.	.	.	.	.	.
	8	12	20	A_X71	40.01-45.00	A_71	12.00-45.00	46.0	.	.	.	.	.	.	.	.	.
	8	12	20	A_X71	45.01-50.00	A_71	12.00-50.00	51.0	.	.	.	.	.	.	.	.	.
	8	12	20	A_X71	50.01-56.00	A_71	12.00-56.00	57.0	.	.	.	.	.	.	.	.	.
76	8	12	20	ADX76	39.00-45.00	AD_76	15.00-45.00	46.0	.	.	.	.	.	.	.	.	.
	8	12	20	ADX76	45.01-50.00	AD_76	15.00-50.00	51.0	.	.	.	.	.	.	.	.	.
	8	12	20	ADX76	50.01-56.00	AD_76	15.00-56.00	57.0	.	.	.	.	.	.	.	.	.
	8	12	20	ADX76	56.01-60.00	AD_76	15.00-60.00	61.0	.	.	.	.	.	.	.	.	.
85	8	12	20	ADX85	43.00-50.00	AD_85	21.00-50.00	51.0	.	.	.	.	.	.	.	.	.
	8	12	20	ADX85	50.01-56.00	AD_85	21.00-56.00	57.0	.	.	.	.	.	.	.	.	.
	8	12	20	ADX85	56.01-60.00	AD_85	21.00-60.00	61.0	.	.	.	.	.	.	.	.	.
	8	12	20	ADX85	60.01-66.00	AD_85	21.00-66.00	67.0	.	.	.	.	.	.	.	.	.
90	8	12	20	ADX90	45.00-50.00	AD_90	25.00-50.00	51.0	.	.	.	.	.	.	.	.	.
	8	12	20	ADX90	50.01-56.00	AD_90	25.00-56.00	57.0	.	.	.	.	.	.	.	.	.
	8	12	20	ADX90	56.01-60.00	AD_90	25.00-60.00	61.0	.	.	.	.	.	.	.	.	.
	8	12	20	ADX90	60.01-66.00	AD_90	25.00-66.00	67.0	.	.	.	.	.	.	.	.	.
100	8	12	20	ADX90	66.01-70.00	AD_90	25.00-70.00	71.0	.	.	.	.	.	.	.	.	.
	8	12	20	ADX100	50.00-56.00	AD_100	33.00-56.00	57.0	.	.	.	.	.	.	.	.	.
	8	12	20	ADX100	56.01-60.00	AD_100	33.00-60.00	61.0	.	.	.	.	.	.	.	.	.
	8	12	20	ADX100	60.01-66.00	AD_100	33.00-66.00	67.0	.	.	.	.	.	.	.	.	.
100	8	12	20	ADX100	66.01-70.00	AD_100	33.00-70.00	71.0	.	.	.	.	.	.	.	.	.
	8	12	20	ADX100	70.01-78.00	AD_100	33.00-78.00	79.0	.	.	.	.	.	.	.	.	.

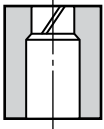

### XSC

**Slug Control eliminates slug pulling**  
Dayton Slug Control is as easy as specifying a catalog number. Add the information that is unique to your application to the die button catalog number. See ordering information. Available on all AD and AH die buttons.

### Dayton Slug Control is Easy to Order

Dayton Slug Control is as easy as specifying a catalog number. Add the information that is unique to your application to the die button catalog number. See the example below:

You must specify **XSC** for alteration, **material thickness** and **clearance per side** as a percent.

Catalog Number				Your Specs		
ADX	13	25	P7.0	XSC	MM0.3	CS5
Type	D	L	P	Alt. Code	Mat'l Th'kness	Clear Per Side (%)

This information will be entered into our computer to generate a program to alter the land of the die button and end your slug pulling problems forever! Call us or contact your Dayton distributor for more information.

### Standard Key Flat Location

Standard Key Flat Location is 0°. Alternative locations of 90°, 180°, or 270° can be specified at **no additional cost**.

### Custom Key Flat Location

Custom Key Flat Locations can be specified as degree required counterclockwise from 0°. **See page 24 for more details.**

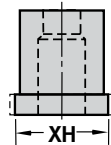
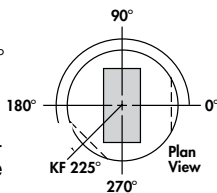

### XH

**Reduced Head Diameter**  
Minimum head diameter equals  $D + 0.00 - 0.03$

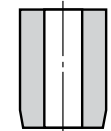

### XBL

**Straight Through Land**  
The land length (B) equals the overall length of the die button. Can be used for bushings, guides and a variety of other applications. Round only.

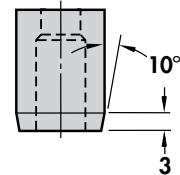

### XAL

**10° Angled Lead on AD\_**  
The angle provides clearance for steps left by CNC machining.

Standard on AN\_ Die Buttons

### How to Order

Specify: Quantity  
Type  
Body Dia. & Length Codes  
P or P & W Dimensions  
Standard Alterations

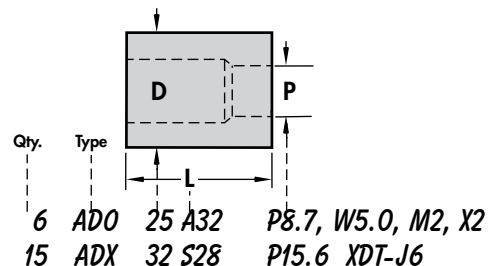

# Tapered Relief Die Buttons

Steel	HRC
A2, M2	60-63

For automotive CNC build applications

Type AN\_ 

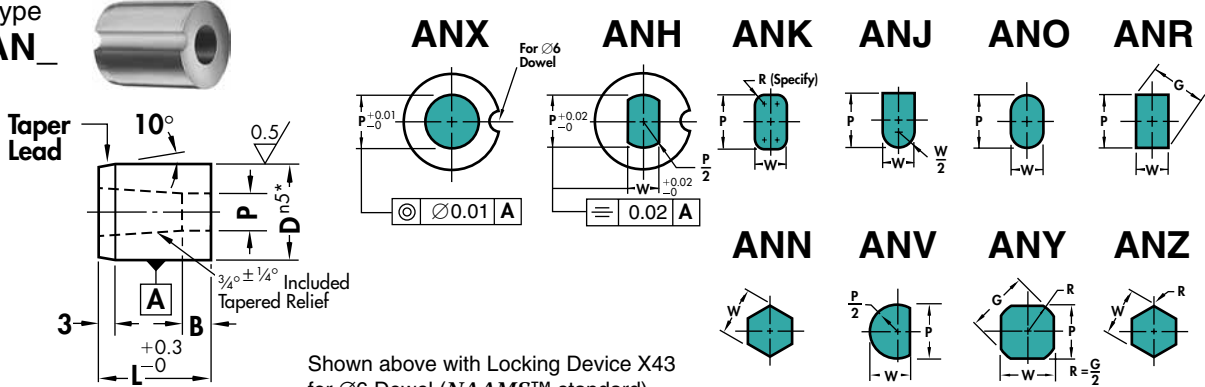

Shown above with Locking Device X43 for  $\varnothing 6$  Dowel (NAAMS™ standard). X43 provided unless otherwise specified.

Check your P&W dimensions to be sure the diagonal G does not exceed the max. shown.

$$G = \sqrt{P^2 + W^2}$$

See page 24 for other Locking Devices (must be specified)

Body D	Std. S	B Alt. A	Alt. B	Type & D	Round Range P	Type & D	Shape		L									
							Min. W	Max. P/G	13	16	20	22	25	28	30	32	35	40
10	4	5	3	ANX10	1.60- 6.80	AN_10	1.30- 6.80	.	.	.	.	.	.	.	.	.	.	.
13	5	8	3	ANX13	3.00- 8.80	AN_13	1.90- 8.80	.	.	.	.	.	.	.	.	.	.	.
16	5	8	3	ANX16	7.40-10.80	AN_16	1.90-10.80	.	.	.	.	.	.	.	.	.	.	.
20	5	10	3	ANX20	9.50-13.60	AN_20	1.90-13.60	.	.	.	.	.	.	.	.	.	.	.
22	6	10	3	ANX22	10.50-15.00	AN_22	1.90-15.00	.	.	.	.	.	.	.	.	.	.	.
25	6	10	3	ANX25	12.00-17.00	AN_25	1.90-17.00	.	.	.	.	.	.	.	.	.	.	.
32	6	12	3	ANX32	16.00-22.00	AN_32	1.90-22.00	.	.	.	.	.	.	.	.	.	.	.
38	8	12	3	ANX38	18.00-27.00	AN_38	1.90-27.00	.	.	.	.	.	.	.	.	.	.	.
40	8	12	3	ANX40	18.00-27.00	AN_40	1.90-27.00	.	.	.	.	.	.	.	.	.	.	.
45	8	12	3	ANX45	18.00-35.00	AN_45	2.40-35.00	.	.	.	.	.	.	.	.	.	.	.
50	8	12	3	ANX50	18.00-40.00	AN_50	4.00-40.00	.	.	.	.	.	.	.	.	.	.	.
56	8	12	3	ANX56	18.00-45.00	AN_56	4.00-45.00	.	.	.	.	.	.	.	.	.	.	.
63	8	12	3	ANX63	18.00-50.00	AN_63	4.00-50.00	.	.	.	.	.	.	.	.	.	.	.
71	8	12	3	ANX71	18.00-56.00	AN_71	4.00-56.00	.	.	.	.	.	.	.	.	.	.	.
76	8	12	3	ANX76	25.00-60.00	AN_76	5.60-60.00	.	.	.	.	.	.	.	.	.	.	.
85	8	12	3	ANX85	25.00-66.00	AN_85	5.60-66.00	.	.	.	.	.	.	.	.	.	.	.
90	8	12	3	ANX90	32.00-70.00	AN_90	5.60-70.00	.	.	.	.	.	.	.	.	.	.	.
100	8	12	3	ANX100	32.00-78.00	AN_100	5.60-78.00	.	.	.	.	.	.	.	.	.	.	.

## Standard Alterations for AN Die Buttons

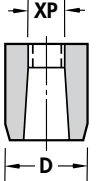
**XP, XW**  P or W Dimensions Larger or Smaller than Standard

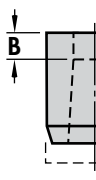
**XL**  Overall-Length Shortened  
Minimum overall length = 6.35

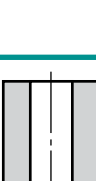
**LL**  Precision Overall-Length  
Same as XL except overall length is held to  $\pm 0.02$ .

**XBL**  Straight Through Land  
The land length (B) equals the overall length of the die button. Can be used for bushings, guides and a variety of other applications. Round only.

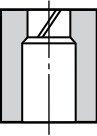
**XSC**  Slug Control eliminates slug pulling  
Dayton Slug Control is as easy as specifying a catalog number. Add the information that is unique to your application to the die button catalog number. See ordering information. Available on all AN die buttons.

### Dayton Slug Control is Easy to Order

Dayton Slug Control is as easy as specifying a catalog number. Add the information that is unique to your application to the die button catalog number. See the example below:

You must specify **XSC** for alteration, **material thickness** and **clearance per side** as a percent.

Catalog Number				Your Specs		
ADX	13	25	P7.0	XSC	MM0.3	CS5
Type	D	L	P	Alt. Code	Mat'l Th'kness	Clear Per Side (%)

This information will be entered into our computer to generate a program to alter the land of the die button and end your slug pulling problems forever! Call us or contact your Dayton distributor for more information.



# Guide Bushings

## For Punch Point Support

Land Length V	
P	V
0.80-1.7	2P
1.71-2.4	P + 1.7
2.41-10.8	.82P + 2.1

Steel	HRC
A2	60-63

Applies to all products on this page

### Guide Bushing Alterations

Product	Round	Shape
XH	.	.
XP	.	.
XT	.	.
TT	.	.

See pages 10 & 11 for an explanation of these alterations. Locking Devices are on page 24.

### How to Order

Specify: Quantity  
Type  
Body & Length Codes  
P or P & W Dimensions  
Steel  
Standard Alterations

4 AEX 06-13 P2.0, XH 7.0  
2 AFO 10-10 XP7.0, W2.9, A2  
3 AGK 16-16 P6.6, W6.1, R1.0, A2

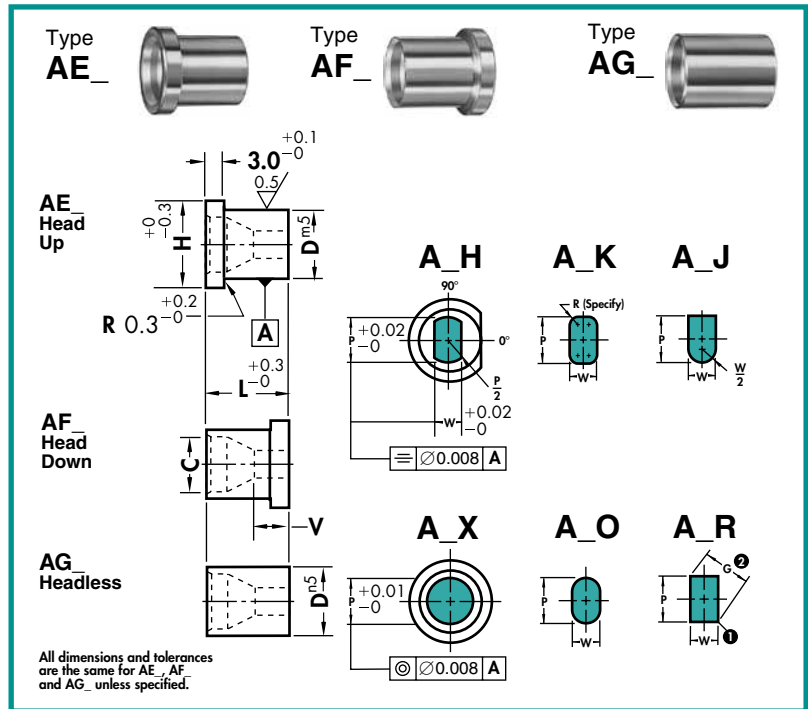

Type	Body D	H	Round Range P	Shape Min. W	Max. P/G	C' Bore Dia. C	L			
							8	10	13	16
AG Headless	05	8	1.6- 3.2	1.3- 3.2		3.6	8			
AF Head Down	06	9	1.6- 3.9	1.3- 3.9		4.6		10		
AE Head Up	08	11	2.4- 5.4	1.3- 5.4		6.6			13	
	10	13	3.2- 6.8	1.3- 6.8		8.2				16
	13	16	5.4- 8.8	1.9- 8.8		11.4				
	16	19	7.4-10.8	1.9- 10.8		Full Taper				

① 0.2 Max. Fillet (Typical)    ② Check your P&W dimensions to be sure the diagonal G does not exceed the max. shown.  $G = \sqrt{P^2 + W^2}$

### How to Order

Specify: Quantity  
Type  
Body Dia. & Length Codes  
P or P & W Dimensions  
Standard Alterations

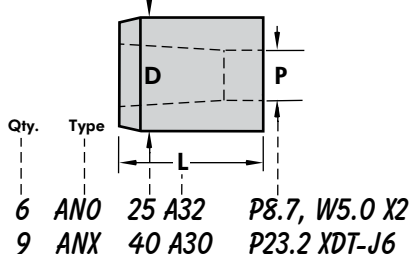

#### Standard Key Flat Location

Standard Key Flat Location is 0°. Alternative locations of 90°, 180°, or 270° can be specified at **no additional cost**.

#### Custom Key Flat Location

Custom Key Flat Locations can be specified as degree required counterclockwise from 0°. See page 24 for more details.

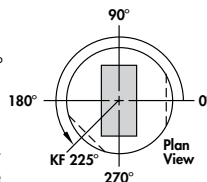

# EDM Button Blanks

Steel	HRC
A2, M2	60-63

## How to Order:

Specify: Quantity  
Type  
Body Dia. & Length Codes  
B&P Dimensions if Required

8	AHE	40-A35	M2
2	ADU	13-30	A2
4	AHE	32-B25	A2

For the fastest delivery use the hole (P) dimensions given in the chart. If another hole is desired simply specify "XP" and give the dimension.

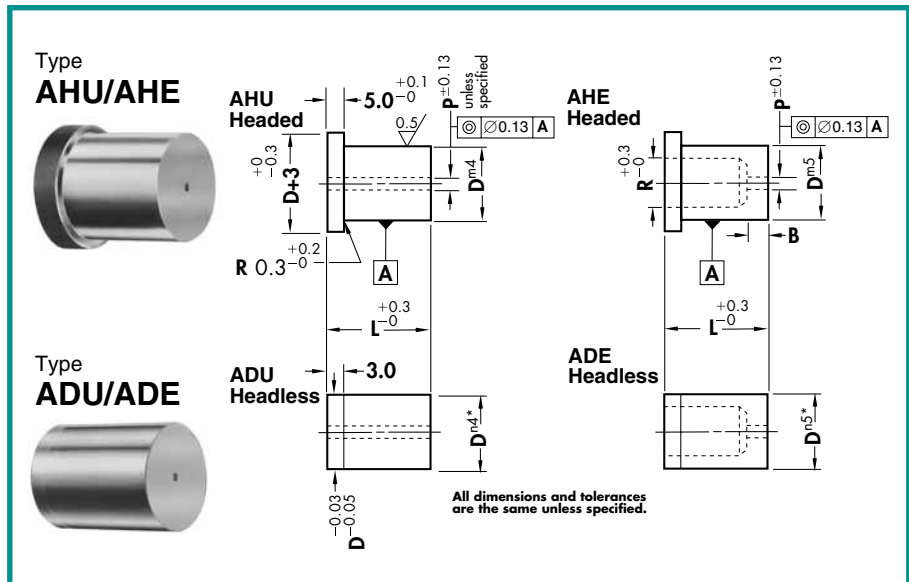

Type	Body D	P	AHE/ADE B			AHE/ADE R	L									
			Std. S	Alt. A	Alt. B		20	22	25	28	30	32	35	40	45	
AD_ AH_	8	0.8	—	—	—	—										
	10	0.8	4	8	—	6.0	•	•	•	•	•	•	•	•	•	
	13	1.6	5	8	—	8.0	•	•	•	•	•	•	•	•	•	
	16	1.6	5	8	—	9.5	•	•	•	•	•	•	•	•	•	
	20	1.6	5	12	20	12.0	•	•	•	•	•	•	•	•	•	
	22	1.6	6	12	20	15.0	•	•	•	•	•	•	•	•	•	
	25	1.6	6	12	20	17.5	•	•	•	•	•	•	•	•	•	
	32	1.6	6	12	20	21.0	•	•	•	•	•	•	•	•	•	
	38	1.6	8	12	20	27.0	•	•	•	•	•	•	•	•	•	
	40	1.6	8	12	20	27.0	•	•	•	•	•	•	•	•	•	
	45	3.2	8	12	20	36.0	•	•	•	•	•	•	•	•	•	•
	50	3.2	8	12	20	41.0	•	•	•	•	•	•	•	•	•	•
	56	3.2	8	12	20	46.0	•	•	•	•	•	•	•	•	•	•
63	3.2	8	12	20	51.0	•	•	•	•	•	•	•	•	•	•	
71	3.2	8	12	20	57.0	•	•	•	•	•	•	•	•	•	•	
AD_ Only	76	3.2	8	12	20	61.0	•	•	•	•	•	•	•	•	•	
	85	3.2	8	12	20	67.0	•	•	•	•	•	•	•	•	•	
	90	3.2	8	12	20	71.0	•	•	•	•	•	•	•	•	•	
	100	3.2	8	12	20	79.0	•	•	•	•	•	•	•	•	•	

# Jektole® Clearance

## The Key to Increased Productivity

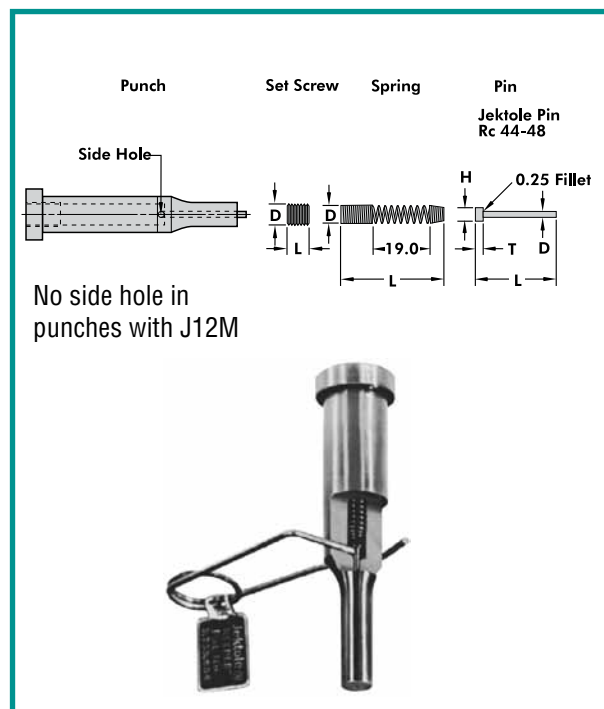

### JEKTOLE® In Production

- Requires less press tonnage
- Reduces pressure required to strip the punch, reduces punch wear
- Produces minimal burr
- Doubles (and often triples) piece output per grind
- Reduces total punch costs

### JEKTOLE® In Maintenance

- Keeper Key—holds pin in retracted position
- Eliminates the need for disassembly before grinding
- Maintains proper pin extension
- Reduces downtime for regrinding

### Universal Jektole Components

		J2M	J3M	J4M	J6M	J9M	J12M
<b>EJECTOR PINS</b>							
Overall Length	L	28.0	35.0	49.4	49.4	56.5	56.5
Pin Diameter	D	0.43	0.68	1.04	1.47	2.26	3.05
Head Diameter	H	1.2	1.8	2.4	3.0	4.0	4.8
Head Thickness	T	0.8	1.2	1.6	1.6	2.4	2.4
<b>SPRINGS</b>							
Outside Diameter	D	2.1	2.4	3.3	4.3	5.0	7.0
Free Length	L	60.3	60.3	81.0	76.2	68.9	65.1
<b>SCREWS</b>							
Screw Size	D	M2.6	M3	M4	M5	M6	M8
Screw Length	L	5	5	5	5	6	6

### Jektole Design Limits

DIMENSION		J2M	J3M	J4M	J6M	J9M	J12M
Min. Shank Dia.	D	4.4	5.0	6.8	8.8	10.4	14.0
Min. Point Dia.	P	1.3	2.0	3.0	4.0	6.0	7.2
Max. Point Lgth.		32	38	41	41	41	41
Max. Shank Lgth.	S	87	87	84	84	84	70

# Shear Angles

## For Round Punches Only

**XS19**  
Nail Point

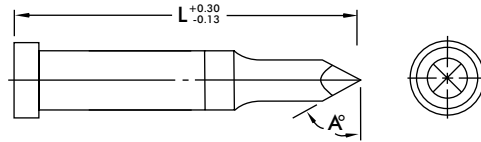

**XS20**  
Chamfer

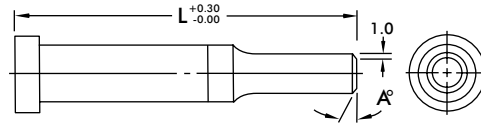

## For Round & Shape Punches

Shown as reflected view.

**XS21**  
Conical

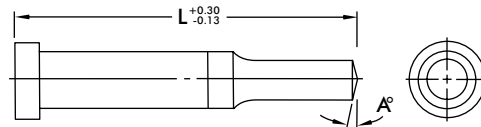

**XS22**  
Double Shear

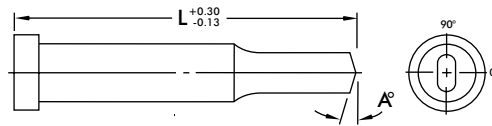

**XS23**  
Single Shear

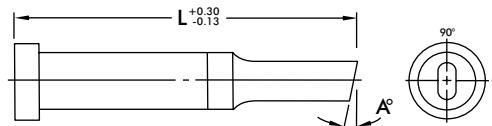

**XS24**  
Single Shear  
Angle with Flat

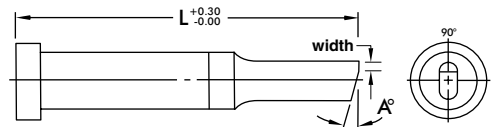

Shear Angles can be applied to all punch points. These angles are used primarily to reduce slug pulling. Single and Double Shears can be used to reduce the punching force as well as minimize slug pulling. These alterations are pre-priced and do not add to the standard delivery of the product.

Shear Angles are also available on Classified Shapes, but are available as special order only.

For your reference standard head flat and dowel locations are at 0°.

Simply add the alteration code shown next to the drawings, and the angle desired, to your punch catalog number. Tolerance on all angles is ±15 minutes.

LL not available on XS19, XS21, XS22, and XS23.

## How to Order:

Specify: Quantity  
Product  
Alteration

5 AJB 20 100 PS XS23 A3°

# Change Retainers

## Air Cylinder Type — For Headed Punches

### Engage or disengage punches in seconds

Change retainers are used where different hole patterns are required. Various hole patterns can be accomplished without the need for multiple dies. Different parts, such as right and left hand can be run in one die.

Changing hole patterns takes only minutes, sometimes only seconds. A bar holding the punch in position is released to allow the punch to retract up far enough to avoid contact with the material.



Type  
**ARA**  
For Round  
Punches

Type  
**ARAS**  
For Shape  
Punches

Head flat orientation for shape punches

Dowel Hole  
(D=10~25) 2-Ø5.8  
(D=32,40) 2-Ø7.8

5  
8  
T

ØD

Punch  
Retractable Length

Air cylinder can be removed and remounted 90° or 180° from location shown  
Recommended air pressure is 65 – 75 PSI (450 – 520 kPa/cm<sup>2</sup>)  
Minimum pressure: 45 PSI (315 kPa/cm<sup>2</sup>)  
Maximum pressure: 145 PSI (1000 kPa/cm<sup>2</sup>)

Change Retainer includes all necessary screws and dowels, air cylinder and fittings. The fittings supplied are for 6mm tubing and 1/4" tubing. The metric fittings are blue and the inch fittings are orange. Tubing is not included.

Tubing Not Included

### How To Order:

Quantity	Catalog No.
6	ARA16

Catalog Number			L	A	B	C	E	F	θ	T	U	Screw Size
Round	Shape	D										
ARA	ARAS	10		46								M8
ARA	ARAS	13	128	49	30	73	18	25	45	45	41	M10
ARA	ARAS	16										M10
ARA	ARAS	20										M10
ARA	ARAS	25	155	58	38	90	23	29	30	45	45	M10
ARA	ARAS	32										M12
ARA	ARAS	40	208	80	56	125	33	38	30	55	60	M12

Type  
**ART**  
For  
Round  
Punches

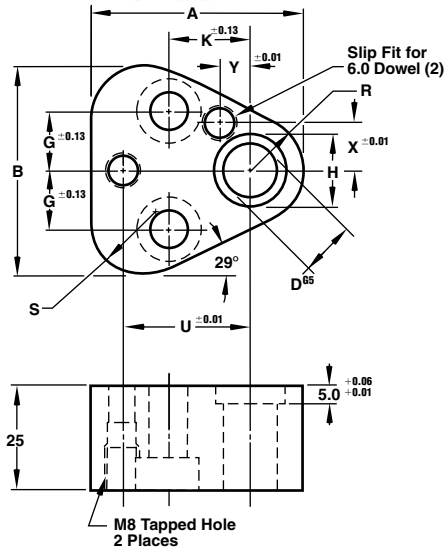

Type  
**ARTS**  
For  
Shaped  
Punches

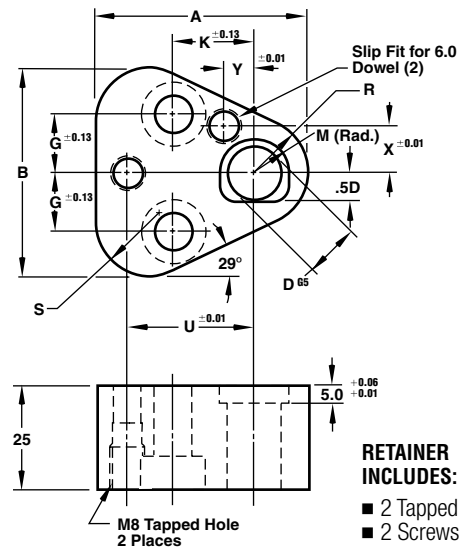

Don't waste time and money building a retainer for just one punch. TRUE LOCATION Retainers offer precise dowel locations allowing CNC machining of the punch and die plates. The dimensional accuracy also permits interchangeability of retainers that before could not have been done without plugging holes and re-machining for dowels.

Use Dayton's Center Dowel Punches and Pilots for the best accuracy. With the dowel located directly over the center-line of the

punch, accumulation of tolerances is eliminated. This provides the best possible alignment. In addition, only one dowel is needed for a round punch, a shaped punch requires a second dowel for radial location. An additional dowel hole is provided for use with die buttons.

- Ground top and bottom
- Case-Hardened to approximately Rc 42

Catalog No.		ART			ARTS			Screw Size						
Type	Code	D	A	B	H	G	K	M	R	S	U	X	Y	
ART/ARTS	10	10.00	44.5	43.7	14.0	11.1	19.0	7.0	9.5	12.0	26.925	9.0	7.5	M8
ART/ARTS	13	13.00	50.8	50.0	17.0	14.3	19.0	8.5	12.7	15.2	29.970	12.0	6.5	M8
ART/ARTS	16	16.00	54.0	53.2	20.0	15.9	19.0	10.0	14.3	16.8	31.750	13.5	6.0	M8
ART/ARTS	20	20.00	60.3	59.5	24.0	17.5	19.0	12.0	17.5	20.0	33.530	16.5	5.0	M10
ART/ARTS	25	25.00	69.9	69.1	29.0	19.8	23.8	14.5	22.2	24.7	40.640	22.0	7.0	M12
ART/ARTS	32	32.00	69.9	69.1	36.0	19.8	23.8	18.0	22.2	24.7	40.640	22.0	7.0	M12

## Shim Plates

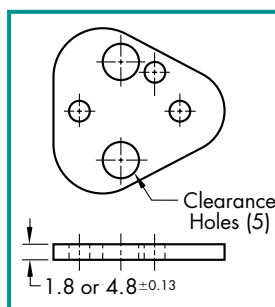

D	1.8 (soft)	4.8 (Rc55)
10	URSP 10 18	URBP 10 48
13	URSP 13 18	URBP 13 48
16	URSP 16 18	URBP 16 48
20	URSP 20 18	URBP 20 48
25	URSP 25 18	URBP 25 48
32	URSP 32 18	URBP 32 48

## How To Order:

Quantity Catalog No.

10 ART10

12 ARTS25

10 URBP 10 48

# Multi-Location Retainers

## Multiple Head Type Punch Retainers

Dayton's innovative Multi-Location retainers provide a simple, low-cost solution to building new dies. These retainers reduce the need for special detailing, saving both design and build time.

Multi-Location retainers are easy to order. Simply specify type, thickness, width and length. (For more information, see How to Order example on the next page.) Order forms are available on request.

Type  
**ARP**

Available In Two Thicknesses  
For Headed Punches

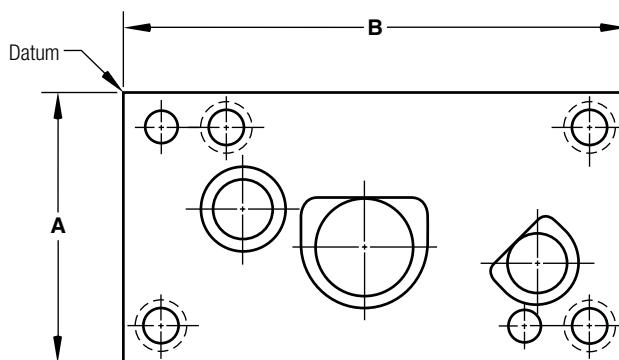

Note:  
Looking at retainer from punch head side.

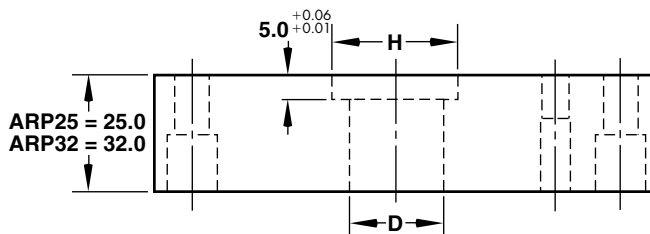

Specify screw and dowel size and location

### Punch Hole Sizes

D	H
4.0	8.0
5.0	9.0
6.0	10.0
8.0	12.0
10.0	14.0
13.0	17.0
16.0	20.0
20.0	24.0
25.0	29.0
32.0	36.0

### Hole Locations From Datum

Dowel Holes	±0.01
Screw Holes	±0.13
Component Holes	±0.01

Standard hardness on ARP retainers is Rc 26-32. They are available hardened to Rc 47-52 by specifying X11 at the end of the catalog number.

Ex: ARP32 70200 X11

Catalog No.		B											
Type	A	60	70	80	90	100	125	150	175	200	225	250	300
ARP	50	5060	5070	5080	5090	50100	50125	50150	50175	50200	50225	50250	50300
	60	6060	6070	6080	6090	60100	60125	60150	60175	60200	60225	60250	60300
	70		7070	7080	7090	70100	70125	70150	70175	70200	70225	70250	70300
	80			8080	8090	80100	80125	80150	80175	80200	80225	80250	80300
	100					100100	100125	100150	100175	100200	100225	100250	100300
	125						125125	125150	125175	125200	125225	125250	125300
	150							150150	150175	150200	150225	150250	150300
	200								200175	200200	200225	200250	200300



# Locking Devices

## Single Flats for Locating Punch Head

Standard key flat locking device is located at 0°. Specify **X2** as shown on the order form example shown below.

Alternate locations of 90°, 180° or 270° may be specified at no additional cost. Specify **X2** and the angle required.

Example: **X2 90°**

## Custom Location

Custom key flat locking device can be located at any angle. Specify **X5** and the angle required counterclockwise from 0°.

Example: **X5 135°**

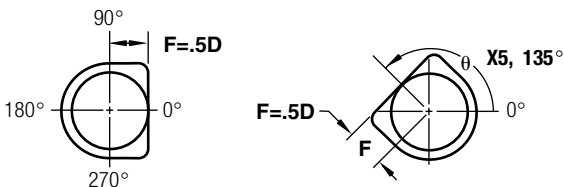

Standard Location

Custom Location

## Flat Tolerances

FLAT	
F	RADIAL
+0.025	0.03/
-0	25.0

# Alterations

## Standard Jackscrew Hole

Jackscrews make it easier to pull retainer off the dowels.

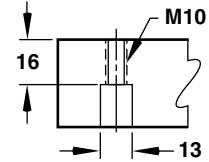

## Special Size

For a custom size, we can remove any amount of material from the side(s) of the retainer. Edges are sawcut ( $\pm 0.8$ ).

## Clearance Holes

Clearance holes or tapped holes can either be detailed or specified on the order as in the How to Order example shown below.

Holes are drilled through the retainer unless otherwise specified.

Location	$\pm 0.3$
Diameter	+0.4 -0

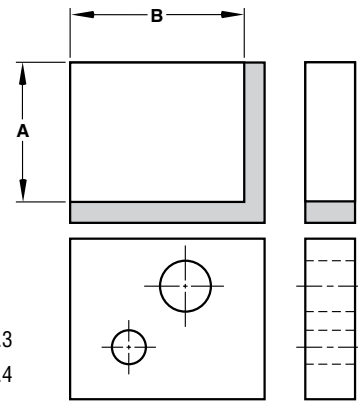

## The following alterations require detail drawings

### Notches

Saw cut notches ( $\pm 0.8$ ) can be cut into any retainer side to clear other tooling.

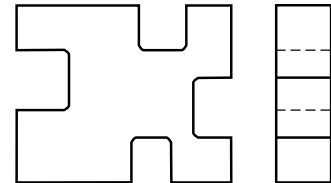

### Angles

Saw cut angles ( $\pm 0.8$ ) can be specified to clear other tooling.

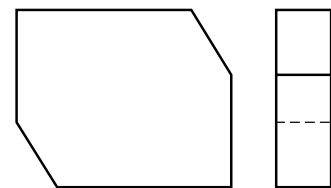

## How To Order:

Furnish the necessary information as indicated below. Order forms for Multi-Location Retainers are available upon request.

Retainer	Catalog No.	Special Size				
ARP 32	70200	A	B			
Multi-Location Retainers						
Hole No.	Component		Location		Locking Device	
	Type	Size	X Axis	Y Axis	Location	Type
1	DOWEL	10.0 S.F.	13.0	-13.0	—	—
2	S.H.C.S.	M10	35.0	-13.0	—	—
3	AJR	16	53.5	-35.5	90°	X2
4	CLEAR	Ø33	108.0	-27.0	—	—
5	JACKSCR.	STD.	25.0	-25.0	—	—

S.F. = Slip Fit

You must specify all dimension from Datum.

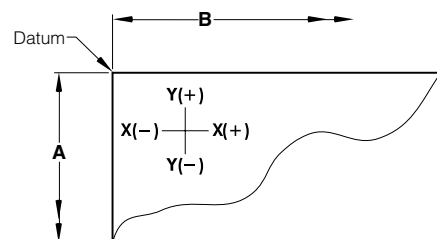

# Urethane Strippers

Strip-Shape Urethane Strippers assure positive stripping and they guard against punch failure by dampening punch vibration by gripping the punch point. The closed end design holds thin stock flat during the stripping cycle, reducing the potential of rejected parts.

Made from specially formulated urethane resins, these rugged strippers are guaranteed to meet your need for clean, fast precise stripping action—with all types of punches. Because of Dayton's unique curing agent, Strip-Shape urethane provides greater load bearing capacity than ordinary urethanes. Lot-to-lot pressure ratings are also much more consistent.

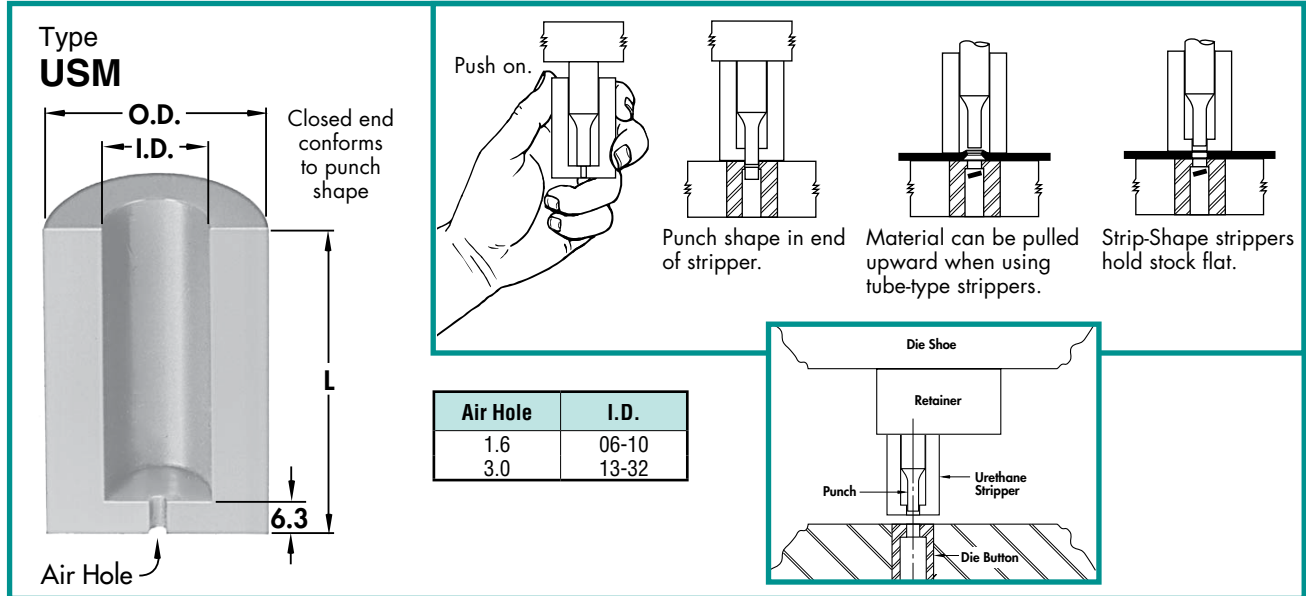

I.D.	O.D.	L	Catalog Number	Pressure at Deflection of		
				3.0	6.5	9.5
06	19	45	<b>USM-06-45</b>	1324	2256	—
		53	<b>USM-06-53</b>	1079	1863	2354
		71	<b>USM-06-71</b>	686	1079	1765
08	21	45	<b>USM-08-45</b>	1471	2207	—
		53	<b>USM-08-53</b>	1324	1961	2942
		71	<b>USM-08-71</b>	981	1618	2648
10	23	45	<b>USM-10-45</b>	1716	2795	—
		53	<b>USM-10-53</b>	1422	2452	3187
		56	<b>USM-10-56</b>	1422	2452	3187
		71	<b>USM-10-71</b>	1128	2010	2697
13	26	45	<b>USM-13-45</b>	2109	3334	—
		53	<b>USM-13-53</b>	1471	2354	3432
		56	<b>USM-13-56</b>	1471	2354	2942
		71	<b>USM-13-71</b>	1275	1961	2452

I.D.	O.D.	L	Catalog Number	Pressure at Deflection of		
				3.0	6.5	9.5
16	30	45	<b>USM-16-45</b>	2354	3825	—
		53	<b>USM-16-53</b>	2158	3531	4511
		56	<b>USM-16-56</b>	2158	3531	4511
		71	<b>USM-16-71</b>	1814	2942	3825
20	38	45	<b>USM-20-45</b>	2452	3923	—
		53	<b>USM-20-53</b>	2158	3629	5590
		71	<b>USM-20-71</b>	1618	2942	4658
25	50	45	<b>USM-25-45</b>	9317	14318	—
		53	<b>USM-25-53</b>	7355	11572	15985
		71	<b>USM-25-71</b>	4904	8336	13485

Urethane Hardness: 95 ± 5 Shore A  
 Max. Recommended Deflection: 15% of Overall-Length.  
 (Pressure Ratings shown in Newtons)

## How To Order:

Qty.      Catalog No.  
 10      **USM 08 71**

# Urethane Stripping Units

Fits retainers with tapped dowel holes only, such as DAYTON retainers: ART, ARTS, BRT, CRT.

When using DAYTON Ball Lock retainers these strippers fit Light Duty punch lengths 71, 80, 90, 100 and Heavy Duty punch lengths 80, 90, 100, 110. On DAYTON Head Type retainers they fit punch lengths 71, 80, 90, 100.

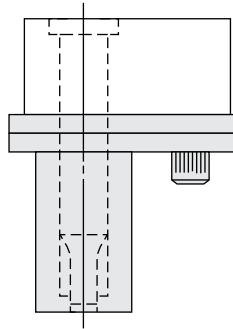

## Urethane Strippers UHM

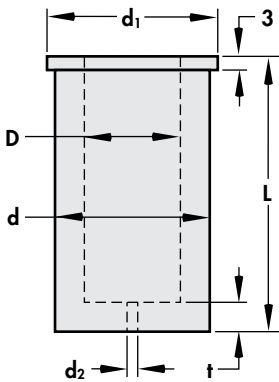

D	d	d <sub>1</sub>	t	d <sub>2</sub>
10	18	21	6	1.6
13	23	26	6	3.0
16	28	31	6	
20	33	36	7	
25	40	43	7	
32	50	55	7	
38	60	65	8	
40	60	65	8	

Catalog Number	D	L	Pressure at Deflection of		
			3	6	9
UHM10-43	10	43	1060	1820	—
UHM10-52		52	900	1650	2170
UHM10-63		63	720	1450	1860
UHM10-72		72	570	1280	1610
UHM13-43	13	43	1700	2850	—
UHM13-52		52	1460	2610	3410
UHM13-63		63	1170	2320	2910
UHM13-72		72	930	2080	2500
UHM16-43	16	43	2310	3900	—
UHM16-52		52	1990	3560	4640
UHM16-63		63	1590	3150	3980
UHM16-72		72	1270	2810	3440
UHM20-43	20	43	2900	4900	—
UHM20-52		52	2500	4470	5820
UHM20-63		63	2000	3950	5000
UHM20-72		72	1590	3420	4330
UHM25-43	25	43	4440	7520	—
UHM25-52		52	3810	6860	8780
UHM25-63		63	3050	6050	7680
UHM25-72		72	2420	5390	6780
UHM32-43	32	43	6840	11390	—
UHM32-52		52	5880	10450	13300
UHM32-63		63	4700	9310	11640
UHM32-72		72	3740	8370	10280
UHM38-52	38	52	9480	19330	29720
UHM38-72		72	5950	11630	18160
UHM40-43	40	43	10100	20190	—
UHM40-52		52	8650	17300	25960
UHM40-63		63	6890	13780	20670

Urethane Hardness: 95 ± 5 Shore A  
 Max. Recommended Deflection: 15% of Overall Length.  
 (Pressure Ratings shown in Newtons)

## Backing Plates UBP

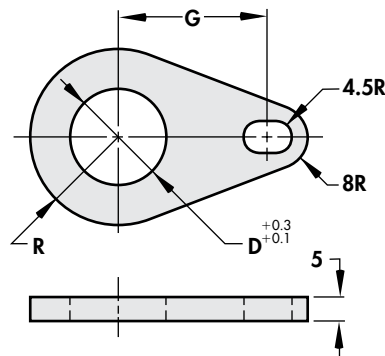

## Retaining Plates URP

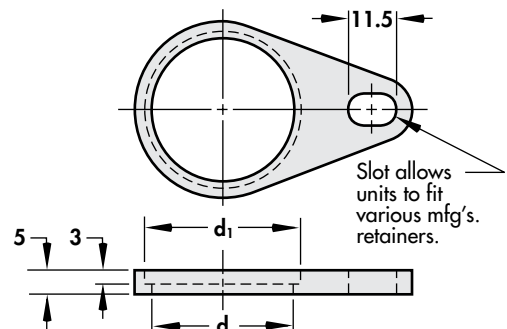

Catalog No. Back Plate	Catalog No. Ret. Plate	D	d	d <sub>1</sub>	R	G	UBP, URB Set EDP No.
UBP10	URP10	10	19	22	13.0	28.0	748579
UBP13	URP13	13	24	27	15.5	31.0	748587
UBP16	URP16	16	29	32	18.0	32.9	748595
UBP20	URP20	20	34	37	20.5	34.8	748609
UBP25	URP25	25	41	44	24.0	39.8	748617
UBP32	URP32	32	51	56	31.0	41.3	748625
UBP38	URP38	38	61	66	36.0	45.0	748633
UBP40	URP40	40	61	66	36.0	45.0	748641

## How to Order:

Qty. Catalog No.  
 12 UHM-16-63  
 12 748595

Set consists of: Backing Plate, Retaining Plate and M8 x 20 Socket Head Cap Screw.

UBP, URP and UHM conform to NAAMS™ standard for Urethane Strippers and Backing/Retaining Plate Set.

# Classified Shapes

## Orientation & Locking

The Locking Device orientation is standard at 0°.

### X2 Standard Location:

Standard location of key flat is at 0°. Alternate locations of 90°, 180° or 270° can be specified at no extra cost.

### X5 Custom Location:

Custom Location of key flat can be specified as X5 and degrees from 0°.

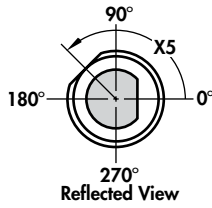

## Views

Views are: reflected view of punch and plan view of die button.

## Corner Dimensions

Dimensions should be to the theoretical sharp corners for C22, C24, C25, C34, C61 and C88. Some reduction of these dimensions will result from fitting the punch and die button under conditions where clearance is 0.04 or less per side.

Fillets matched with sharp corners reduces the clearance per side ( $\Delta$ ). If the clearance is  $0.04\Delta$  or less, DAYTON will break sharp corners when the punches and die buttons are ordered together. This reduces assembly time and the risk of the edge breaking during operation. All back-holes are counterbored.

### Shape centers

Shapes are centered on punch shanks as shown. Shapes in die buttons are also centered as shown with the exception of shapes **C22** and **C34**. Due to the clearance, the P dimension on these shapes will not be centered.

## How to Order:

Specify: Quantity  
Catalog Number  
Classified Shape  
Code  
Point or Hole Dimensions

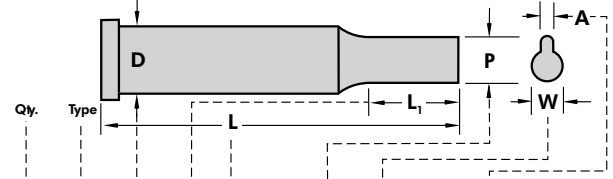

10 APC 10 19 90 C13 P9.5, W8.8 A2.8 X43  
Example: Die Buttons

10 ADC 20 30 C13 P9.5 W8.8 A2.8  $\Delta 0.1$  X43

## Clearance

To assure proper relationship with punches, it is necessary to specify punch dimensions and clearance per side ( $\Delta$ ) when ordering die buttons.

DAYTON will assure the proper clearance of die buttons to the punch when ordered in this manner.

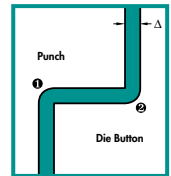

### Notes 1 and 2 — Fillets and Sharp Corners

Normal Grinding methods produce:

- 1 0.2 max fillet on the punch...matching corner sharp on the die button.
- 2 0.2 max fillet on the die button...matching corner sharp on the punch.

## Simplified Specifications...83 Common Shapes — No Detailing Required

90°

<h3>Flatted Rounds</h3> <p>C10**</p> <p>C11**</p> <p>C33**</p>			<h3>Mono Lobes</h3> <p>C13</p> <p>C53</p> <p>C54</p> <p>C55</p> <p>C14</p> <p>C56</p> <p>C57</p> <p>C58</p>			
--	--	--	---	--	--	--

180°

<h3>Miscellaneous</h3> <p>C40</p> <p>C41</p> <p><math>R_1 = .683W - .183P</math> <math>R_2 = 1.183P - .683W</math></p> <p>C42*</p> <p>C43*</p> <p>C93</p> <p>C64*</p> <p>C65*</p> <p>C27</p> <p>C28**</p> <p>C29</p> <p>C16</p> <p>C34*</p>					
---	--	--	--	--	--

0°

<h3>Triangles/Trapezoids</h3> <p>C22*</p> <p>C23</p> <p>C24*</p> <p>C25*</p> <p>C26</p> <p>C36</p> <p>A = 3 sides (equilateral)</p>					
---	--	--	--	--	--

270°

**Keys**

C30

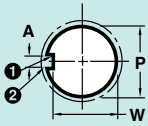

C31

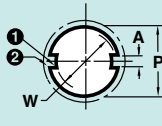

C32

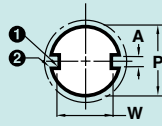

C61

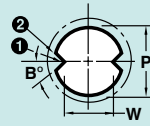

C62

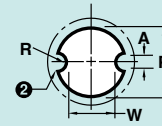

**Polygons**

C12\*\*

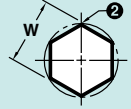

C85\*\*

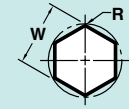

C35

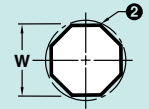

A = Even No. of Sides

C86

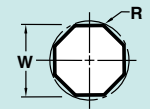

A = Even No. of Sides

C36

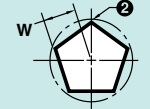

A = Odd No. of Sides

C87

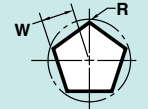

A = Odd No. of Sides

C88

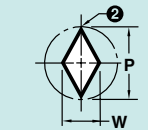

C89

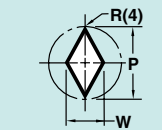

C37

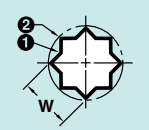

C38

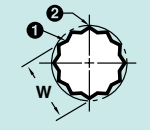

C39

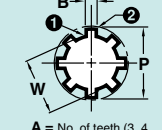

A = No. of teeth (3, 4, 6 or 8 only)

C90\*

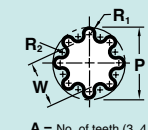

A = No. of teeth (3, 4, 6 or 8 only)

**Multi Lobes**

C19

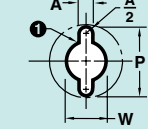

C59

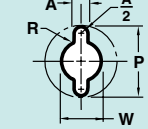

C20

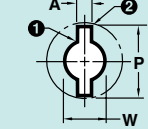

C60

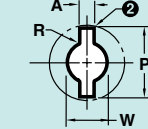

C17

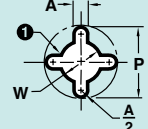

C18

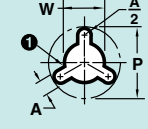

**Duo Tees**

C21\*

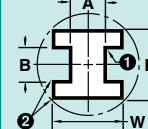

C91\*

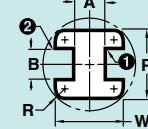

C92

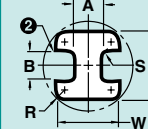

C15\*

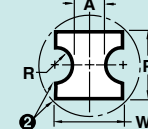

**T's**

C44\*

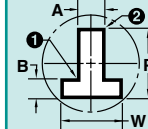

C66\*

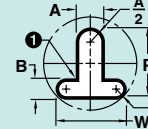

C45\*

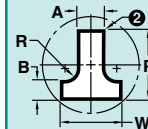

C67\*

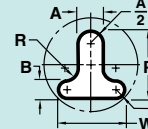

**L's**

C46\*

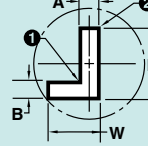

C77\*

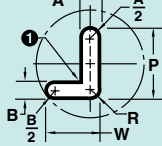

C78\*

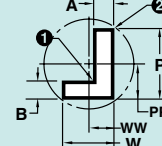

C79\*

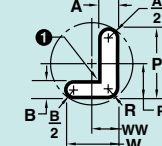

C48\*

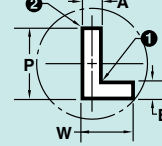

C80\*

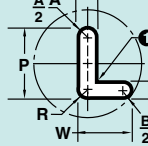

C81\*

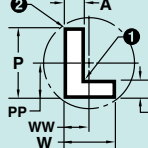

C82\*

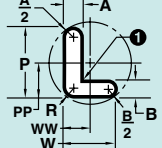

C47\*

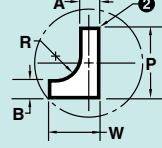

C83\*

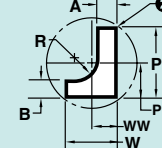

C49\*

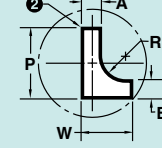

C84\*

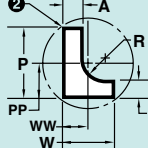

**U's**

C50\*

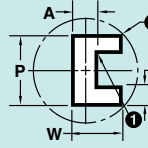

C68\*

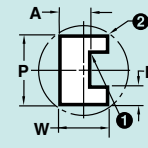

C69\*

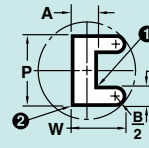

C70\*

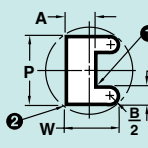

C71\*

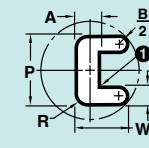

C72\*

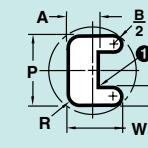

C51\*

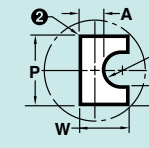

C73\*

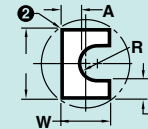

C74\*

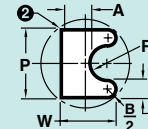

C75\*

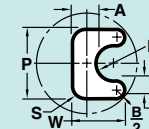

C76\*

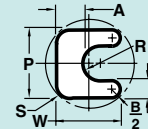

\* Avoid excessive overhang by specifying shaped back-hole on AD\_ and AH\_ or use AN\_ die buttons.

\*\* Now standard. See product pages.

# Locking Devices

## How to Order:

5 ADO 40 30 P16, W6.4, X2  
9 ADR 100 35 P75, W50, X83

## Single and Double Flats

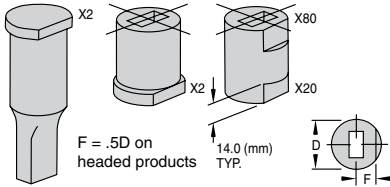

Headless Die Buttons: X20, X80, X50, X90

Body Ø ▶	08	10	13	16	20
F	3.5	4.0	5.5	7.0	8.5
Body Ø ▶	22	25	32	38	40
F	9.5	11.0	14.0	17.0	18.0
Body Ø ▶	45	50	56	63	71
F	20.5	23.0	26.0	29.5	33.5
Body Ø ▶	76	85	90	100	
F	35.5	40.0	42.5	47.5	

## Additional Flats

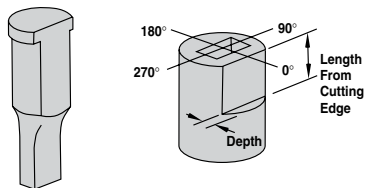

Note: depth of flat is taken from shank, not the head on punches.

## Standard/Alternate Locations

Definitions:

**Standard Location** is at 0°.

**Alternate Location** is 90°, 180° or 270°. Alternate Locations are available at no additional charge.

## Custom Locations

Definition:

**Custom Location** is *any angle other than*: 0°, 90°, 180° or 270°.

## Single Flats: X2, X20, X80

Locking Devices	Punch	Die Button
X2	Top	Bottom
X20	N/A	Bottom
X80		Top

Order Example:

X2 - 90°

## Double Flats: X3

Locking Devices	Punches
X3	Top

Order Example:

X3 - 90°

Second Flat is *always parallel* to the first flat.

## Single Flats: X5, X50, X90

Locking Devices	Punch	Die Button
X5	Top	Bottom
X50	N/A	Bottom
X90		Top

Order Example:

X5 - 135°

## Double Flats: X6

Locking Devices	Punches
X6	Top

Order Example:

X6 - 135°

## Additional Flats

Code	Depth	Length
X81	1.5	13
X82	1.5	16
X83	1.5	20
X84	1.5	Full Length
X85	2.5	13
X86	2.5	16
X87	2.5	20
X88	2.5	Full Length
X89		Specify Dimensions

## Additional Flats

Code	Depth	Length
X91	1.5	13
X92	1.5	16
X93	1.5	20
X94	1.5	Full Length
X95	2.5	13
X96	2.5	16
X97	2.5	20
X98	2.5	Full Length
X99		Specify Dimensions

## Dowel Slots

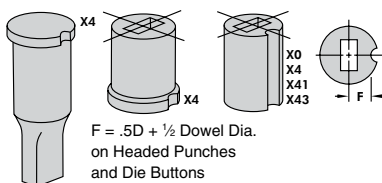

## Dowel Slots: X0\*, X4, X41 & X43

Locking Devices	Dowel Ø
X0*	3
X4	3
X41	4
X43	6

Order Example:

X0 - 180°

## Dowel Slots: X1\*, X7, X71 & X73

Locking Devices	Dowel Ø
X1*	3
X7	3
X71	4
X73	6

Order Example:

X71 - 135°

## Dowel Slot F Dimension for Headless Die Buttons Only

Body Ø ▶	08	10	13	16-25	32-100	
X0/X1	F	.5D	.5D	.5D	.5D	
X4/X7		4.7	5.5	6.7	.5D	.5D
X41/X71		5.2	6.0	7.2	.5D	.5D
X43/X73		6.2	7.0	8.2	.5D+1.0	.5D

## Key Flats vs. Dowel Slots

Maximum hole dimensions in die buttons were designed with key flats in mind. There are instances where, if using a dowel slot, the dowel hole could break into the relief. For this reason there are two ways to specify the location of the dowel. **X0** (standard/alternate location) and **X1**

(custom location) are located .5D from centerline. However, when hole dimensions are approaching the high limit of "P" **X4** (standard/alternate location) or **X7** (custom location) may be specified. This relocates the dowel outward to assure no interference between the dowel and relief.

To determine if you will have an interference problem see Die Button Construction on pages 10 and 11.

\*Available on headless die buttons only



# Surface Treatments and Coatings

Some catalog products can be coated to increase hardness, reduce galling, and improve wear and/or corrosion resistance. These coatings and treatments are available for M2 and PS4 material.

## Surface Treatments

---

**DayKool™ (XCR)**—A cryogenic steel conditioning process used in addition to heat treating. An effective way to achieve optimum toughness, improved strength, and dimensional stability. Used primarily with hard, thick materials.

**DayTride® (XN)**—A low temperature, cost-effective surface application that treats all exposed surfaces. Provides increased dimensional stability. Ideal for punches and die buttons. Approx. hardness: RC65-73.

**XVP**—A thin film coating provides superior hardness (harder than carbide). Super-smooth finish on the point helps reduce galling and maintenance. Ideal for higher-than-normal punching frequency.

**XPS**—Super-smooth polish on the point to reduce galling and improve punch life. Use with the appropriate coating for your application to maximize punch life and reduce maintenance costs. Excellent for extruding applications.

## Abrasive Wear

---

**DayTiN® (XNT)**—Excellent wear resistance and lubricity. Not recommended for stainless steel, copper, or nickel. A good general-purpose coating. Approx. hardness: \*Vickers 2300.

**TiCN (XCN)**—Ultra-hard (harder than carbide), thin coating. Provides superior abrasive wear resistance and lubricity. A very good general-purpose coating for all materials. Upgrade over XNT. Approx. hardness: \*Vickers 3000.

**DayTAN™ (XAN)**—Ultra-hard (harder than carbide), high-aluminum coating. Provides high temperature resistance. Well-suited for applications where surface heat is generated. Ideal for HSLA, dual phase, and TRIP steels. Upgrade over XCN. Approx. hardness: \*Vickers 3400.

**ZertonPlus™ (XNA)**—Superior hardness (harder than carbide); provides superior abrasive wear resistance and excellent lubricity. Provides highest temperature resistance, thermal shock stability, & hot hardness. Approx. hardness: \*Vickers 3200.

## Adhesive Wear

---

**XNM**—A solid lubricant coating. Provides both lubricity and wear resistance not available from other PVD or CVD processes. Ideal for aluminum, copper, pre-painted, and galvanized steels. Approx. hardness: \*Vickers 2000.

**XCD**—Diamond-like carbon coating. Combines high hardness with an extremely low coefficient of friction. Good protection against abrasive and adhesive wear. Ideal for aluminum. Approx. hardness: \*Vickers 5000.

**XCDH**—Super-smooth finish combined with advanced DLC coating for a very low coefficient of friction with extremely high wear resistance. Approx. hardness: \*Vickers 5000.

**XCDP**—Super-smooth finish combined with a DLC coating for a very low coefficient of friction with high wear resistance. Excellent for stamping aluminum. Approx. Hardness: Vickers 2800.

## Extrusion Coatings

---

**XNP**—The ultimate coating for improved resistance to galling; excellent wear resistance, superior surface finish, and high lubricity. Ideal for extruding and forming applications. Tolerance is  $\pm .005$  mm. Approx. hardness: \*Vickers 3100.

**XNAProgress (XNAP)**—Ultra-hard coating that absorbs shear stress; provides excellent high-temperature resistance. Ideal for stamping where tools are exposed to extreme stress profiles. A good alternative to TD coating without the dimensional changes associated with that process. Approx hardness: \*Vickers 3200.

## Miscellaneous Coating

---

**CRN**—Excellent adhesion, high toughness, and good corrosion resistance. Primary applications are metal forming (copper, brass, & bronze), metal die casting, and plastic injection molding. Approx. hardness: \*Vickers 1800-2100.

\* Vickers used when RC exceeds 80.

## Commitment to Quality & Customer Satisfaction

*Dayton Lamina is a leading manufacturer of tool, die and mold components for the metal-working and plastics industries. As a customer-focused, world-class supplier of choice, we provide the brands, product breadth, distribution network and technical support for all your metal forming needs.*

*Our goal is to give our customers the most innovative and value-added products and services.*



# DAYTON Lamina™

a MISUMI Group Company



Lamina® LEMPCO

\*Dayton Lamina's line of Danly products is available only to North America.

[www.daytonlamina.com](http://www.daytonlamina.com)