

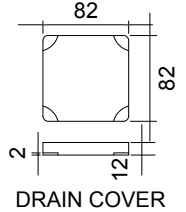

# CUBE-X WM 120L W/DRAWER WALL MOUNT WASHBASIN

ART. NO.: 1031084 | RECTANGLE

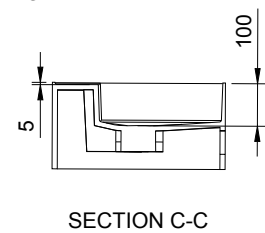
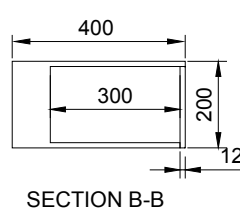
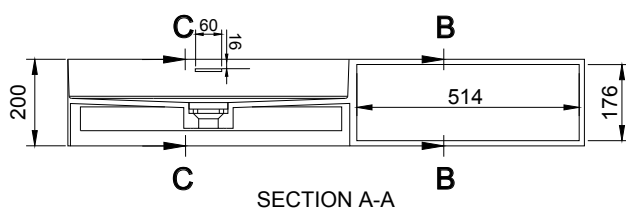
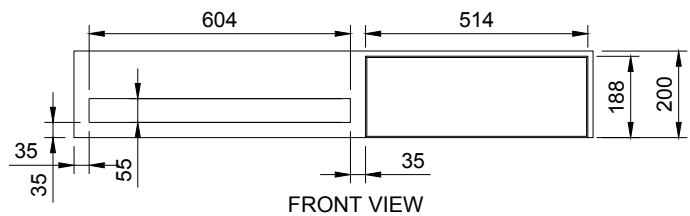
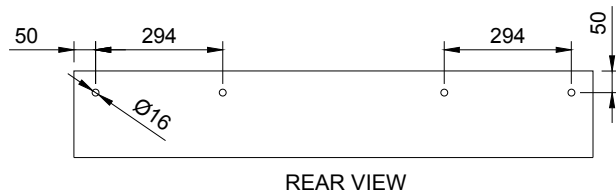
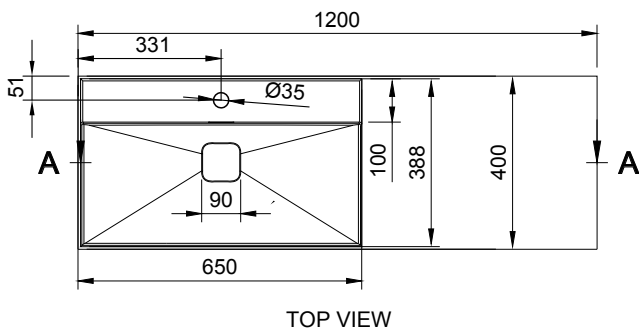

## SPECIFICATIONS

### MATERIAL

INFINITE<sup>®</sup> Solid Surfaces

### AVAILABLE COLORS



### PRODUCT SIZE

L1200 x D400 x H200mm

### GROSS/NET WEIGHT

48.5kg / 43.0kg

### WATER CAPACITY

17.0L

### REMARKS

Not Include Waste Pipe

## ACCESSORIES LIST



9000060  
Pop-Up Drainage



9000090  
Magic Sponge 1pc



9000283  
M8 Screws 4pc

### \*OPTIONAL



9000018  
Chorme Waste Drainage