

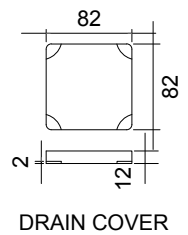

CUBE-X WM 90L W/DRAWER WALL MOUNT WASHBASIN

ART. NO.: 1031083 | RECTANGLE

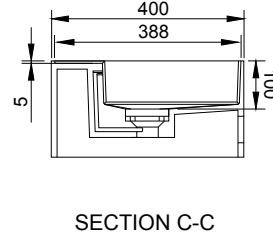
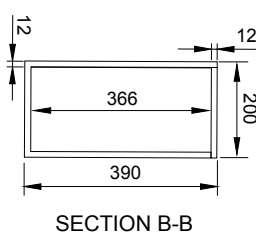
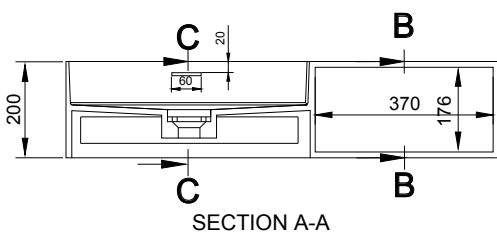
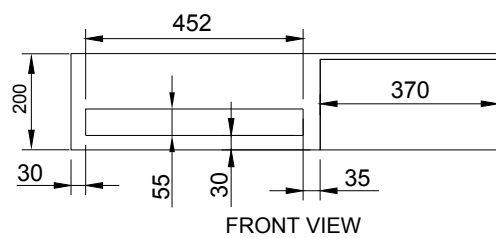
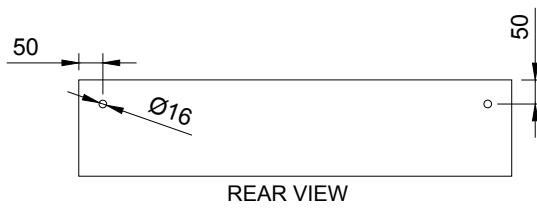
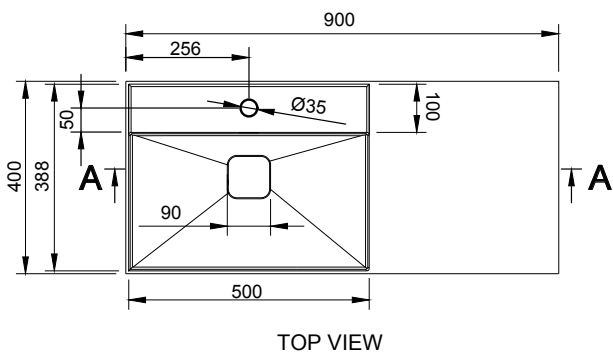

SPECIFICATIONS

MATERIAL

INFINITE[®] Solid Surfaces

AVAILABLE COLORS



PRODUCT SIZE

L900 x D400 x H200mm

GROSS/NET WEIGHT

35.0kg / 31.0kg

WATER CAPACITY

13.0L

REMARKS

Not Include Waste Pipe

ACCESSORIES LIST



9000060
Pop-Up Drainage



9000090
Magic Sponge 1pc



9000283
M8 Screws 4pc

*OPTIONAL



9000018
Chorme Waste Drainage