

8 7 6 5 4 3 2 1

OUTLINE FOR ASCO® 300 SERIES TRANSFER SWITCHES (D3ATS/D3NTS) 30-200 AMPERES, TYPE 3R/4/4X/12 ENCLOSURE

GENERAL NOTES

1. TYPE 3R/4/4X/12 WALL MOUNTED ENCLOSURE.
2. STANDARD FINISH – LIGHT GRAY, ANSI 61.
3. SINGLE DOOR, RIGHT SIDE HINGE, SIDE PADLOCK HASP AND PLATED DOOR CLAMPS ON LEFT SIDE.
4. TERMINALS – SCREW TYPE LUGS FOR EXTERNAL POWER CONNECTIONS.
5.  = CENTER OF GRAVITY.
6. THREE POLE SWITCH WITH SOLID NEUTRAL SHOWN FOR REFERENCE.
7. NEUTRAL CONFIGURATIONS:

AN OPTIONAL FULL RATED NEUTRAL CONFIGURATION FOR EACH SOURCE AND THE LOAD MAY BE PROVIDED. WHEN EQUIPPED IT IS IN ONE OF THE FOLLOWING FORMATS AS SPECIFIED BY THE CATALOG NUMBER NO. NEUTRAL TYPE:

- (A) SOLID (COPPER BUS) NEUTRAL
- (B) SWITCHED NEUTRAL POLE

SWITCH RATING (AMPS)	RANGE OF WIRE
30-150	(1) #14 TO 4/0 AWG AL-CU WIRE
200	(1) #14 TO 4/0 AWG COPPER WIRE

APPROXIMATE SHIPPING WEIGHT, LBS (KG)

AMP SIZE	POLES	WEIGHT
30-200	A2 & B2	87 (39)
	A3 & B3	90 (40)

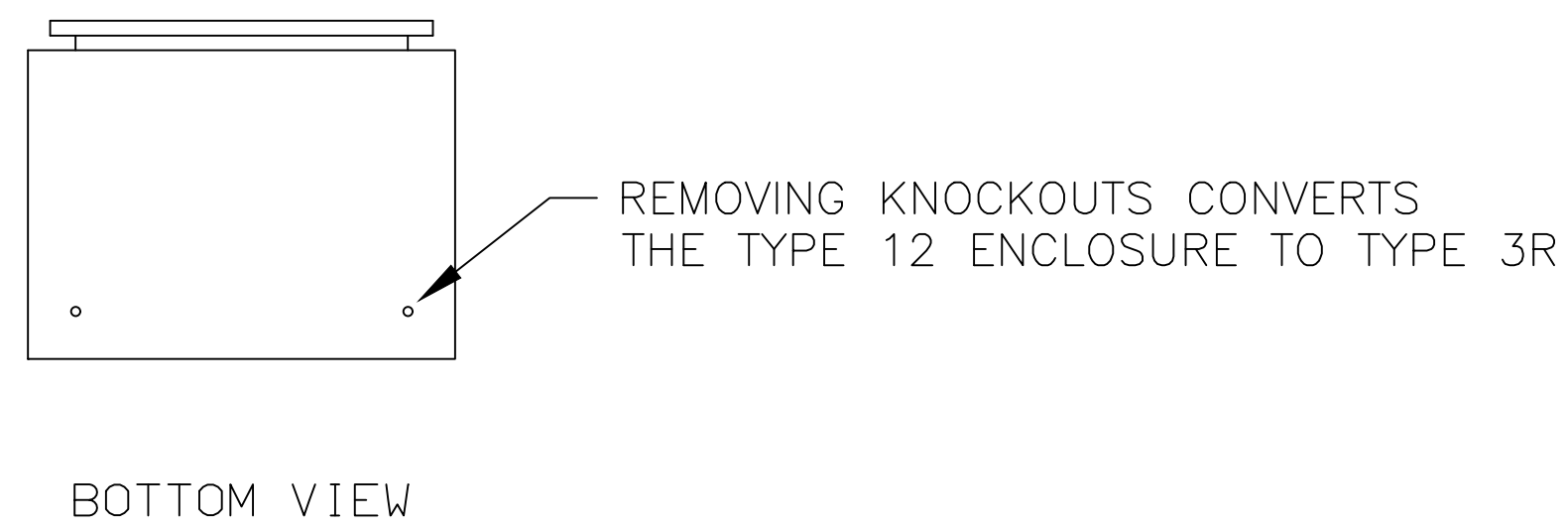
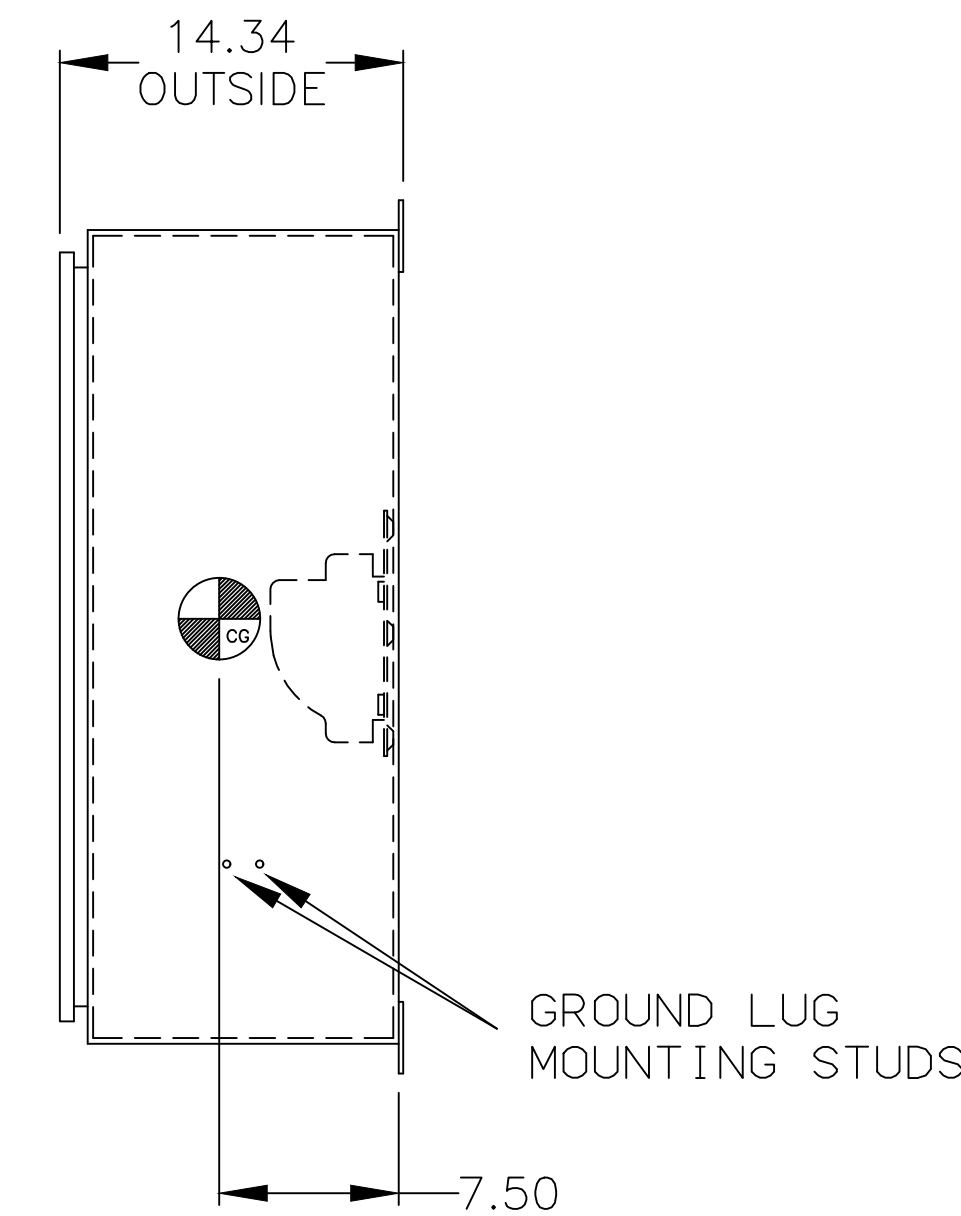
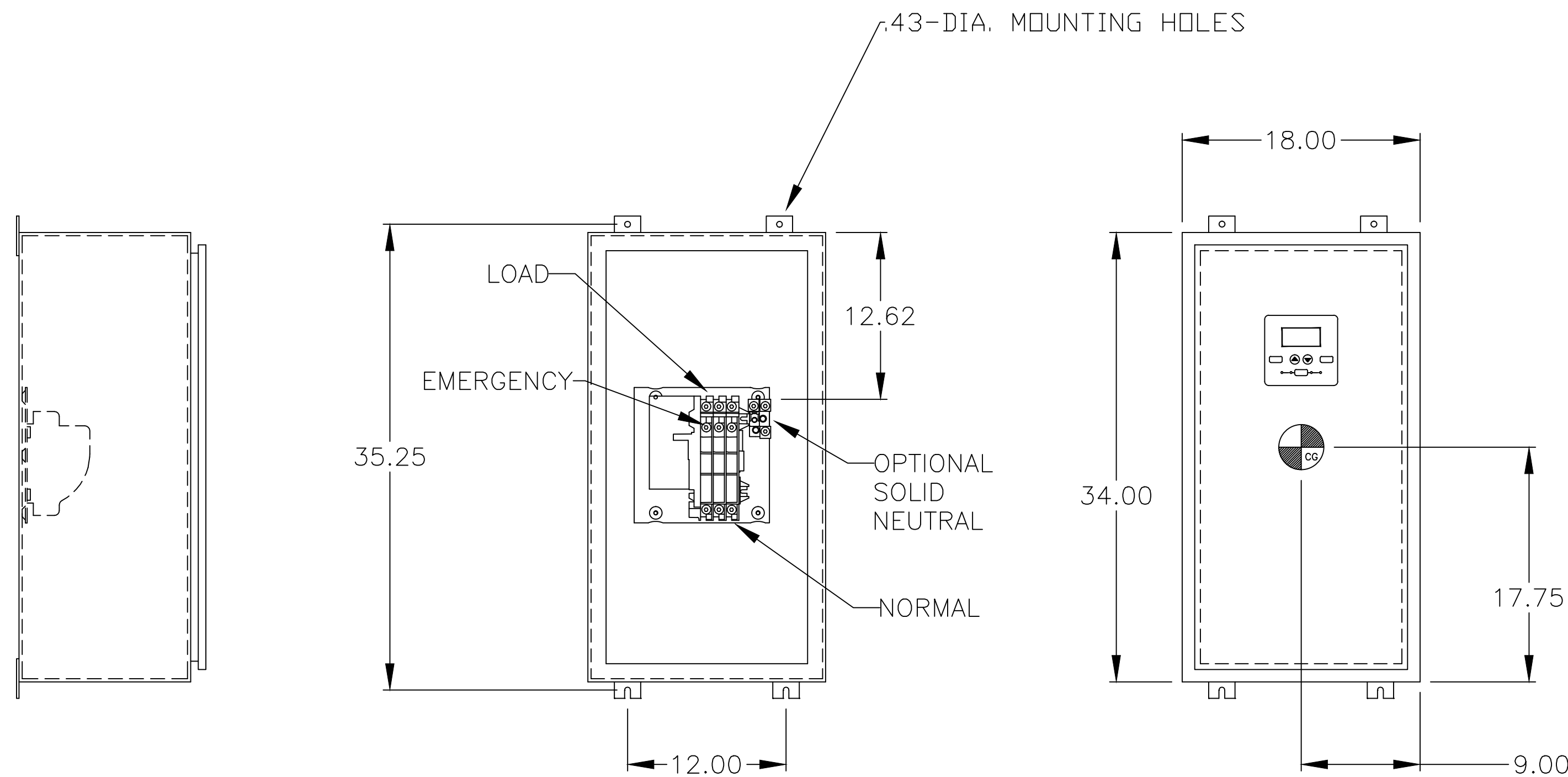

BIG LAKE SUPPLY LLC
 (866)321-6855
sales@biglakesupply.com
www.transferswitch4less.com

B	252058	WK	BK	12/03/14
SEE ECN				
A	248677	BWM	SDH	5/30/14
SEE ECN				
—	245266	BWM	SDH	11/6/13
ISSUE				

PROJECT NAME:		REV. TO SHEET	ECN NO.	BY	APP.	DATE
COMPOSITE OUTLINE						
300 SERIES, D3ATS/D3NTS RATED 30-200 AMPERES						
TYPE 3R/4/4X/12 ENCLOSURE						
BY	DATE	MANUFACTURING TOLERANCES TO BE IN ACCORDANCE WITH ASCO PROCEDURE MP-1-003. FOR PLASTIC PARTS SEE MP-1-055	ASSEM. REF. NO.	COMPUTER GENERATED DRAWING		
DRAWN BY	BWM	11/6/13		SCALE	NONE	SIZE DS
CHECKED				PROPERTY OF ASCO POWER TECHNOLOGIES. USE PERMITTED FOR OUR WORK ONLY. ALL RIGHTS OF DESIGN OR INVENTION ARE RESERVED.		
PROJECT APPROVAL	SDH	11/6/13		DWG. NO.	978723-002	
FINAL APPROVAL				DRAWING B	ECN NO. 252058	SHEET 1 OF 1