

Manual Thermion 2



Description

Thermion 2 thermal imaging riflescopes are designed for use with hunting weapons both at night-time and during the day in adverse weather conditions (fog, smog, rain) as well as having the obstacles (branches, tall grass, dense bushes etc.) hindering the target detection.

Unlike the riflescopes based on electrical-to-optical converters, thermal imaging riflescopes do not require an external light source and are resistant to high illumination level.

Application areas of the riflescopes are as follows: hunting, observation and orientation under conditions of limited visibility.

Package Contents

- Thermal imaging riflescope Thermion 2
- APS2 Battery Pack (APS2 and APS3 for XP50 model)
- APS battery charger
- Mains charger
- USB cable
- Case
- Cloth for cleaning optics
- Quick start guide
- Warranty card
- APS3 battery cover

Specifications

Model	XQ38	XQ50	XP50
-------	------	------	------

SKU	76545	76546	76544
Microbolometer			
Type	uncooled		
Resolution, pixels	384x288		640x480
Pixel size, microns	17		
Frame refresh rate, Hz	50		
Optical Specifications			
Lens, mm	F35 F/1.0	F50 F/1.0	
Magnification, x	2.5-10	3.5-14	2-16
Eye relief, mm/inch	50/1.96		
Field of view (H), °/m@100	10,7/18,7	7.5/13.1	12.4/21.8
Diopter adjustment, D	-3/+5		
Detection distance (Object of "deer" type), m/y	1350/1475	1800/1970	
Aiming Reticle			
Click value (H/V), mm@100 m – when magnifying, x	18 – 2.5x 9 – 5x 4.5 – 10x	13 – 3.5x 6.5 – 7x 3.25 – 14x	21 – 2x 10.5 – 4x 5.25 – 8x 2.6 – 16x
Click range, mm@100 m (H/V)	3600/3600	2600/2600	4200/4200
Display			
Type	AMOLED		
Resolution, pixels	1024x768		
Operating Features			
Diameter of the riflescope body to assemble the mounting rings, mm	30		
Power Supply, V	3–4.2		
Battery type / Capacity / Rated Output Voltage	Li-Ion Battery Pack APS2 / 2000 mAh / DC 3.7 V (removable) or		

	Li-Ion Battery Pack APS3 / 3200 mAh / DC 3.7 V (removable)*		
	Li-Ion Battery Pack APS3 / 3200 mAh / DC 3.7 V (built-in)		
External Power Supply	Micro USB type B (5 V)		
Battery Packs (built-in APS3 and removable APS2) operating time at temp. = 22 °C (Wi-Fi off), hrs	7		
Max. recoil power on rifled weapon, Joules	6000		
Max. recoil power on smoothbore weapon, caliber	12		
Degree of protection IP code (IEC60529)	IPX7		
Operating temperature, °C / °F	-25 – +50 / -13 – +122		
Dimensions with an eyecup, mm/inch	399x78x83 / 15.7x3.07x3.27	412x78x83 / 16.22x3.07x3.27	416x78x83 / 16.38x3.07x3.27
Weight (without removable battery), kg/oz	0.9 / 31.75		
Video Recorder			
Photo / video resolution, pixels	1024x768		
Video / photo format	.mp4 / .jpg		
Built-in memory	16 GB		
Wi-Fi Channel**			
Frequency	2.4 GHz		
Standard	802.11 b/g		

*Available separately for XQ models

**The reception range may vary depending on various factors: obstacles, other Wi-Fi networks.

Features

- Stadiametric rangefinder (estimate distance to object)
- Built-in 3-axis accelerometer gyroscope (slope angle indication)
- Four observation modes: Forest, Rocks, Identification and User

- Three calibration modes: manual, semi-automatic and automatic
- Smooth Digital Zoom
- A large number of electronic reticles
- Scalable reticles (reticle graduation changes proportional to Zoom)
- 5 zeroing profiles (10 distances per profile)
- One-shot “Freeze Zeroing” function
- Precise “Zoom zeroing” (reducing the minute of angle click when zooming in)
- 8 color modes
- Defective microbolometer pixel removal function
- “Display off” function
- “Image Detail Boost” function, which increases the sharpness and overall image detail.
- Wi-Fi. Remote control and observation with a smartphone
- Heavy caliber shock resistance: 12-gauge, 9.3x64, .375H&H

Video Recording

- Built-in photo and video recorder with sound recording
- 16 GB internal memory
- Integration with iOS and Android devices.
- Youtube. Live video streaming and recording in the Internet via smartphone and using a free Stream Vision application

Battery Pack



- Built-in 3200 mAh Battery Pack APS3
- Quick Change Li-Ion Battery Packs APS2/APS3
- You can charge the built-in and external Battery Packs APS2 and APS3 via micro USB port

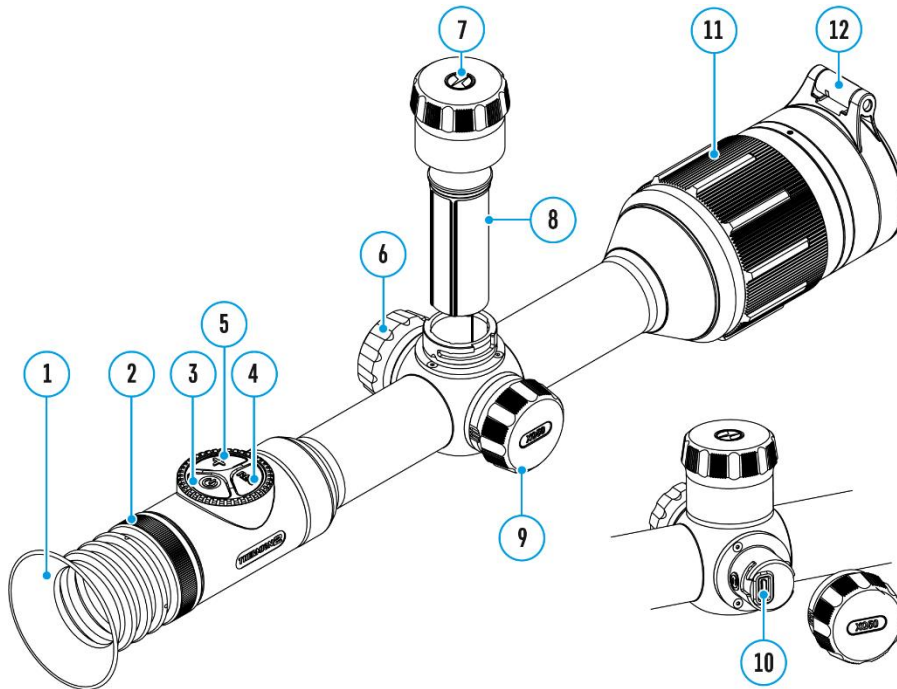















Components and Controls



1. Eyecup
2. Eyepiece diopter adjustment ring
3. ON/OFF button
4. REC button
5. ZOOM button
6. Controller
7. Battery compartment cover
8. Battery Pack APS2
9. Micro-USB cover
10. Micro-USB port
11. Lens focus ring
12. Lens cover

Button Operation

Operation	Button
Power device on	 short press
Power device off	 long press for 3 secs

Turn display off	 long press for less than 3 secs
Turn display on	 short press
Calibrate the microbolometer	 short press
Control discrete digital zoom	 short press
Smooth Zooming	 rotation
PiP on/off	 long press
Video Recorder	Button
Start/pause/resume video recording	REC short press
Stop video recording	REC long press
Switch to video / photo mode	REC long press
Capture Photo	REC short press
Main Menu	Button
Enter main menu	 long press
Navigation through menu	 rotation
Enter menu items	 short press
Confirm value	 short press
Exit menu items	 long press
Exit main menu	 long press
Quick Menu	Button
Enter quick menu	 short press
Switch between quick menu options	 short press
Parameter change	 rotation
Exit quick menu	 long press

Using the Battery Pack

Battery Charging

Thermion 2 thermal imaging riflescopes come with a built-in rechargeable lithium-ion Battery Pack APS3 and a removable rechargeable lithium-ion APS2 Battery Pack (APS2 and APS3 for XP50 model). The batteries should be charged before first use.

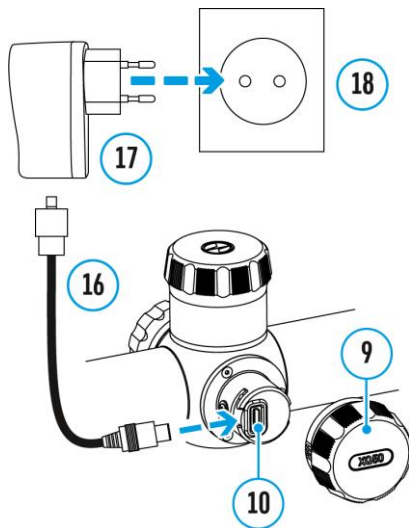

1. Open the microUSB cover (9) by turning it counter clockwise.
2. Attach the microUSB plug of the USB cable (16) to the microUSB socket (10) in the body of the riflescope.
3. Attach the second plug of the USB cable (16) to the USB port on the mains adapter (17). Plug the device into a 100–240 V power outlet (18).

Attention! When charging batteries via the microUSB connector (10) in the body casing of the riflescope, the built-in Battery Pack is the first to be charged. Once it is fully charged, the removeable Battery Pack begins charging. When the device is in use, power consumption occurs in reverse order.

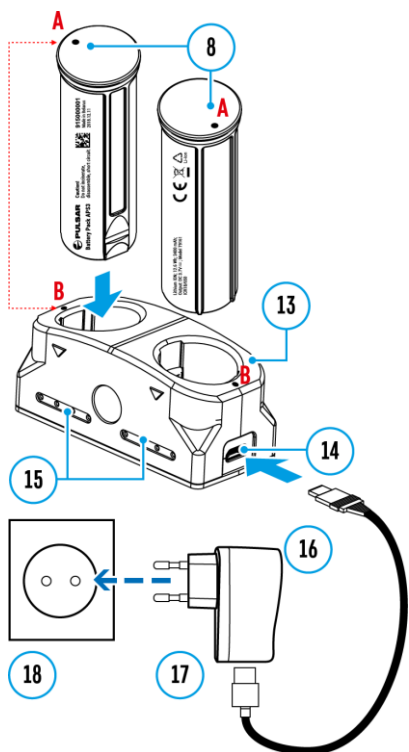

The rechargeable lithium-ion APS2 and APS3* Battery Packs may be recharged using the APS charger:**

1. Fully insert the rechargeable Battery Pack (8) supplied with your device, or purchased separately, along the guide rail into the APS charger slot (13).

2. Point A on the battery and Point B on the charger should be aligned.
3. Two batteries* can be charged at the same time – a second slot is provided for this.
4. Attach the microUSB plug of the USB cable (16) to the socket (14) of the battery charger (13). Plug the adapter into a 100–240 V power outlet (18).
5. Attach the second plug of the USB cable (16) to the USB port on the mains adapter (17).

The LED indicator (15) will display the battery charge status:

LED Indicator***	Battery Charge Status
●	Battery charge from 0 to 10%. Charger not connected to the mains power supply
✶	Battery charge from 0 to 10%. Charger connected to the mains power supply
●●●●	Battery defective. Do not use the battery!
●	Battery charge from 10 to 20%
●●	Battery charge from 20 to 60%
●●●	Battery charge from 60 to 95%
●●●●	Battery completely charged. Can be disconnected from the charger

* Available separately for XQ models

** Included in the delivery package.

*** The LED indicator displays the current level of charge of the battery for 30 seconds when the APS charger is not plugged in. When the power is connected, the display shows the current status of the battery constantly, the LEDs additionally flickering to indicate the battery charging process.

Battery Installation

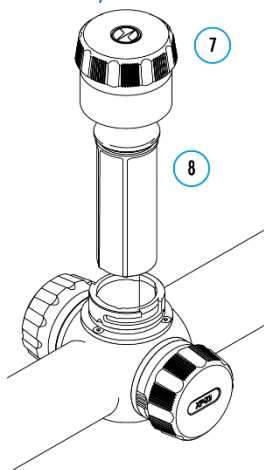

1. Turn the battery cover **(7)** counter clockwise and remove.
2. Install the battery **(8)** into the battery compartment along the special guides in the device casing designed for it.
3. When properly installed, the battery is locked into the slot with a special clip.
4. Replace the battery compartment cover **(7)**, turning it clockwise

Switching and Changing the Batteries

Thermion 2 devices are powered by 2 batteries: built-in Battery Pack APS3 and removable Battery Pack APS3/APS2.



1. If there are two batteries in the device, two battery icons are displayed in the status bar (1 - built-in battery, 2 - removable battery). The battery from which the device is powered is displayed in blue, inactive - in gray.
2. If there is no removable battery in the device, only one blue icon of the internal battery is displayed in the status bar.
3. When both batteries are fully charged, the device is powered by the removable battery. If there is low removable battery level, the device will switch to the built-in battery.
4. When charging the batteries using the micro USB port **(10)**, the built-in battery is charged first. When the built-in battery charge level reaches 100%, the device switches to charging the removable battery. The battery level is displayed in percentage above the icons in the status bar.
5. It is possible to replace removable battery with device turned on when it is powered by built-in battery (the device will continue to work properly).

Attention! When removing the removable battery from the device, if the device is powered by it, the device will reboot and switch to operation from the built-in battery. When installing a removable battery with a sufficient charge level, the device will automatically switch to it.

Precautions

- Always use the APS charger supplied with the device (or purchased separately) to charge APS batteries. Using an unsuitable charger can cause irreparable damage to the battery and fire.
- Do not charge the battery immediately after bringing it from cold to warm. Wait at least 30 minutes for the battery to warm up.
- Do not leave the battery unattended while charging.
- Do not use the charger if it has been modified or damaged.
- Do not leave the battery in a charger connected to the mains after charging is complete.
- Do not expose the battery to high temperatures or naked flames.
- Do not use the battery as a power source for devices that do not support APS 5 batteries.
- Do not disassemble or deform the battery or charger.

- Do not drop or strike the battery or charger.
- The battery and charger must not be immersed in water.
- Keep the battery out of the reach of children.

Recommendations for Use

- The batteries should be partially charged (50 to 80 %) for long-term storage.
- The battery is to be charged at an ambient temperature of 0°C to +35°C or the lifespan of the battery will decrease significantly.
- When using the battery at sub-zero ambient temperatures, the battery capacity decreases. This is normal and not a defect.
- Do not use the battery at temperatures outside the range of -25°C to +50°C or it may reduce battery life.
- The battery is short circuit protected. However, any situation that may cause short-circuiting should be avoided.

External Power Supply

External power can be supplied from an external source, such as a Power Bank (5 V).

1. Connect the external power supply to the micro USB port **(10)** of the riflescope.
2. The riflescope switches to external power source, while built-in Battery Pack APS3 and removable Battery Pack APS2 (or APS3*) will gradually recharge.
3. A rechargeable battery icon  indicating a percentage of the battery life will appear in the status bar.
4. When you turn off external power source, the riflescope switches over to the removable battery without turning off. When there is no removable battery or low power level the device switches to the built-in battery.

Attention! Charging Power Bank APS2 / APS3 batteries at air temperatures below 0 °C can result in reduced battery life. When using external power, connect Power Bank to the switched-on riflescope, which have worked for several minutes.

* Available separately for XQ models.

Operation

Mounting On the Weapon

To ensure accurate shooting the **Thermion 2** riflescope should be properly mounted on the weapon.

- The riflescope is fixed using the mount, which is purchased separately. Use only high-quality mounts and rings that are designed especially for your weapon. Follow the mounting manufacturer's recommendations on the installation procedure and use the proper tool.

- When mounting the riflescope, adjust the position on the weapon so that proper (comfortable) holding of weapon ensures the distance between the riflescope and eye (eye relief) specified by the [Technical Specifications](#). Failure to comply with this recommendation may result in injury to the shooter by the parts of the riflescope eyepiece when shooting.
- It is recommended to install the riflescope as low as possible, at the same time it should not be in contact with barrel or receiver.
- In order to avoid pinching the riflescope body, a tightening torque for the screws of the mounting rings must be not more than 2.5 Nm. A torque wrench is recommended to control the tightening torque.
- Before using the riflescope when hunting, follow instructions in the [Zeroing](#) section.
- It is recommended to use an eyecup while using the riflescope in the dark in order to avoid detection of camouflage. Mounting the eyecup on the riflescope eyepiece is carried out using built-in magnets.

Powering On and Image Setting

1. Remove the lens cover **(12)**.
2. Turn the unit on with a short press of the **ON/OFF (3)** button.
3. Adjust the resolution of the icons on the display by rotating the diopter adjustment ring on the eyepiece **(2)**.
4. Rotate the lens focus ring **(11)** to focus on the object being observed.
5. Enter the main menu with a long press of the controller button **(6)** and select the desired calibration mode: **manual (M)**, **semi-automatic (SA)** or **automatic (A)** (for more details, see the [Microbolometer Calibration](#) section).
6. Calibrate the image with a short press of the **ON/OFF (3)** button (when calibration mode **SA** or **M** has been selected). Close the lens cap before manual calibration.
7. Select the required operating mode (**Forest, Rocks, Identification, User**) in the main menu. User mode allows you to configure and save custom brightness and contrast settings, as well as one of three modes as a base.
8. Activate the quick menu by briefly pressing the controller button **(6)** to adjust the brightness and contrast of the display (see the [Quick Menu Functions](#) section).
9. Press the **ZOOM (5)** button successively to change the magnification ratio of the riflescope.

While the icon  is visible on the screen, rotate the controller ring (6) for smooth digital zooming from the current magnification.
10. Power the device off with a long press of the **ON/OFF (3)** button.

Attention! It is forbidden to point the riflescope lens at intensive energy sources, such as laser radiation emitting devices or the sun. It can disable the riflescope electronic components. Warranty does not cover damage arising from failure to comply with the operating rules.

Zeroing



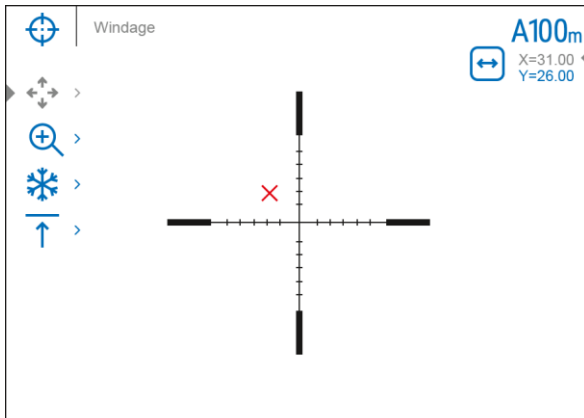



Zeroing is recommended to be done at the temperature close to the riflescope operating temperature.





Step 1. Make a shot

1. Mount the weapon with the riflescope installed on a bench rest.
2. Set a target at a certain distance.
3. Adjust the riflescope according to the [Powering On and Image Setting](#) section.
4. Select the zeroing profile (see [Zeroing Profile](#)  main menu item)
5. Point a weapon at the center of the target and shoot.

Step 2. Align the reticle with the impact point

1. If the impact point does not match the aiming point (center of the riflescope's reticle), press and hold down the controller button **(6)** to enter the main menu.
2. Rotate the controller ring **(6)** to select the **Zeroing**  submenu. To confirm the selection, briefly press the controller button **(6)**.
3. Set the zeroing distance value (see **Zeroing**  menu item => [Add New Distance](#)  submenu).
4. Confirm the selected zeroing distance value by long pressing the controller button **(6)**.
5. The [Zeroing Parameters Settings](#)  additional menu will appear on the screen.
6. Cross hairs appear in the center of the display . X and Y coordinates of the cross hairs are in the upper right corner.
7. Rotate the controller ring **(6)** to select the icon .
8. Press the controller button **(6)** briefly.
9. Holding the reticle in the aiming point, move the cross hairs by rotating the controller ring **(6)** until the cross hairs match the point of impact. To switch the direction, briefly press the controller button **(6)**.

One-shot "Freeze Zeroing" function:

Not to hold the reticle at the aiming point, you can use the [Freeze](#) function – freezing the zeroing screen (refer to **Zeroing**  menu item => **Distance** submenu => **Zeroing Parameters Settings**  submenu => **Freeze**  submenu).

Step 3. Save the coordinates

1. To save the new reticle position, press and hold the controller button **(6)**. The reticle is aligned with the point of impact and the submenu  exits.
2. Press and hold the controller button **(6)** again to exit the zeroing settings menu - the message "Zeroing coordinates saved" appears, confirming the successful operation.
3. Fire a second shot - now the point of impact and the aiming point must be matched.

Smart Reticle Function

When changing the riflescope digital magnification, the reticle that appears on the display is scaled; the reticle appearance will change (enlarge or reduce) proportionally to the magnification. It allows the use of the rangefinder reticles with any digital magnification.

*Only for scalable reticles X51Fi-300, M56Fi, M57Fi

Microbolometer Calibration

Calibration enables to equalize the microbolometer temperature and eliminate the image defects (such as vertical bars, phantom images etc.).

There are three calibration modes: **manual (M)**, **semi-automatic (SA)** and **automatic (A)**. Select the required mode in the [Calibration Mode](#)  item.

M mode (manual)

- Close the lens cover **(12)** and press the **ON/OFF (3)** button briefly.
- Open the cover after the calibration is completed.

SA mode (semi-automatic)

- Press the **ON/OFF (3)** button briefly to activate calibration.
- There is no need to close the lens cover (internal shutter covers the microbolometer).

A Mode (automatic)

- The riflescope is calibrated autonomously according to the software algorithm.
- There is no need to close the lens cover (internal shutter covers the microbolometer).

- In this mode, the riflescope may be calibrated by the user with the **ON/OFF (3)** button.

Note: a display image freezes until the calibration is in progress.

Discrete Digital Zoom

The riflescope functionality allows you to quickly increase the basic magnification (see **Magnification** line in the table of [Technical Specifications](#)) by 2 and 4 times (8 times for XP models), as well as to return to the basic magnification.



- Press the **ZOOM (5)** button successively to change the magnification ratio of the riflescope.
- While the icon  is visible on the screen, rotate the controller ring **(6)** for smooth digital zooming from the current magnification.

Image Detail Boost

The “**Image Detail Boost**”  function increases the sharpness of the contours of heated objects, which increases their detail. The result of the function depends on the selected mode and observation conditions: the higher the contrast of objects, the more noticeable the effect. This option is enabled by default, but can be disabled in the main menu.





The description of enabling/disabling the **Image Detail Boost** function is available [here](#).

Status Bar



The status bar is at the bottom of the display and shows the information on the actual operating status of the riflescope, including:

1. Color Mode (shown only when the Black Hot color mode is selected)
2. Actual zeroing profile (e.g., A)
3. Zeroing distance (e.g., 100 m)
4. Observation mode (e.g., Identification)
5. Calibration mode (a countdown timer  00:03 will appear instead of the calibration icon when in automatic calibration mode with 3 seconds remaining until automatic calibration)
6. Current compound magnification
7. Microphone
8. Wi-Fi connection
9. Auto Shutdown function (e.g., 5 min.)
10. Clock
11. Power supply:

- Battery discharge level   (when riflescope is powered by a built-in or removable battery).
- External battery power indicator  (if the riflescope is powered by an external power supply).
- Battery indicator  with current percentage of charge (when charging from an external power source).

Quick Menu Functions

The basic settings (adjusting brightness and contrast, using the function of smooth digital zoom, a stadiametric rangefinder, information on the current profile and distance) can be changed using the quick access menu.

- Press the controller button **(6)** briefly to enter the quick menu.
- A short press of the controller button **(6)** enables you to switch between functions, as described below.

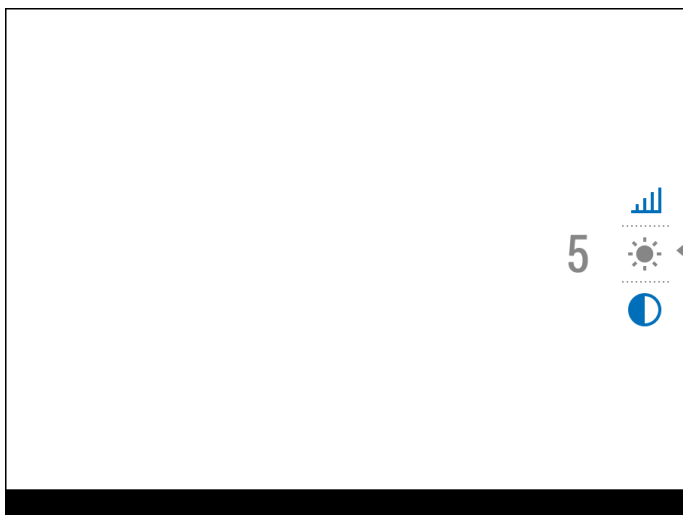

Brightness  – rotate the controller ring **(6)** to change the display brightness value from 00 to 20.

Contrast  – rotate the controller ring **(6)** to change the image contrast value from 00 to 20.

A100  – information on the current profile and zeroing distance in this profile (e.g., profile A, zeroing distance of 100 m). This information is always displayed in the status bar. Rotate the controller ring **(6)** to switch between the zeroing distances in the selected profile. This function is available if there are two or more distances in the profile.

Stadiametric rangefinder  – rotating the controller ring **(6)**, change the distance between the special mark points to determine the distance to the observed object (for more details on the rangefinder, see the [Stadiametric Rangefinder](#) section).

Base mode  – it allows you to select one of the three observation modes as a base for the User mode.

- Press and hold the controller button **(6)** to exit the menu or wait 10 seconds to exit automatically.





Main Menu Functions

Enter the Main Menu







1. Enter the main menu with a long press of the controller button **(6)**.
2. To move through the main menu items, rotate the controller ring **(6)**.
3. Press the controller button **(6)** briefly to open subitems of the main menu.
4. Press and hold the controller button **(6)** to exit from a subitem of the main menu.
5. Automatic exit from the main menu occurs after 10 seconds of inactivity.

General View of the Menu

Tab 1

Menu	Mode
	
	<input checked="" type="checkbox"/> On
	A
	>
	10
	<input checked="" type="checkbox"/> On
	Automatic
	>

Tab 2

Menu	Microphone
	<input checked="" type="checkbox"/> On
	White hot
	>
	>
	>
	>
	

Mode

The devices have three operating modes of the thermal imager: Forest (observation mode of objects within low thermal contrast conditions), Rocks (observation mode of objects within high thermal contrast conditions), Identification (high detailization mode), User (individual brightness and contrast settings).

Each mode has been created to provide the best image quality of a wild nature object being observed within various observation conditions.

1. Press and hold the controller button **(6)** to enter the main menu.
2. Rotate the controller ring **(6)** to select the **Mode**  menu item.
3. Press the controller button **(6)** briefly to enter the Mode submenu.
4. Rotate the controller ring **(6)** to select one of the modes: Forest, Rocks, Identification, User.
5. Press the controller button **(6)** briefly to confirm the selection.

Forest

This is the best mode when searching and observing within field conditions, against the background of leaves, bushes and grass. The mode is highly informative about an object being observed as well as landscape details.

Rocks

This is the best mode when observing objects after a sunny day or within urban conditions.

Identification



This is the best mode when observing objects within adverse weather conditions (fog, mist, rain and snow). It allows you to recognize the characteristics of an object being observed more clearly. Zoom increase may be accompanied by insignificant image graininess.

User

It allows you to configure and save custom brightness and contrast settings, as well as one of the three modes as basic.

Image Detail Boost

Turn on/off **Image Detail Boost**:

1. Press and hold the controller button **(6)** to enter the main menu.
2. Rotate the controller ring **(6)** to select the **Image Detail Boost**  menu item.
3. To turn Image Detail Boost off, briefly press the controller button **(6)**. 
4. To turn Image Detail Boost on, briefly press the controller button **(6)**. 

Zeroing Profile

This item of the main menu allows you to select one of five profiles (A, B, C, D, E) to use. Each profile includes the following parameters:

- A set of zeroed distances
- Reticle color
- Reticle type

Different profiles can be used when using the riflescope on different weapons or when shooting with different bullets.

1. Press and hold the controller button **(6)** to enter the main menu.
2. Rotate the controller ring **(6)** to select the **Zeroing Profile**  menu item.
3. Press the controller button **(6)** briefly to enter the Zeroing Profile submenu.
4. Rotate the controller ring **(6)** to select one of the zeroing profiles (marked with the letters A, B, C, D, E).
5. Confirm your selection with a short press of the controller button **(6)**.
6. The name of the selected profile appears in the status bar at the bottom of the display.

Reticle Setup

This main menu item allows you to select the reticle shape, color and brightness.

1. Press and hold the controller button **(6)** to enter the main menu.
2. Rotate the controller ring **(6)** to select the **Reticle Setup**  menu item.
3. Press the controller button **(6)** briefly to enter the Reticle Setup submenu.

Reticle Type

Selection of the aiming reticle shape.

1. Rotate the controller ring **(6)** to select the **Reticle Type**  submenu.
2. Press the controller button **(6)** briefly to enter the Reticle Type submenu.
3. Rotate the controller ring **(6)** to select the desired aiming reticle shape from the list that appears. The reticle type changes as the cursor goes down the reticle list.
4. Press the controller button **(6)** briefly to confirm the selection.

Reticle Color

Selection of reticle color.

1. Rotate the controller ring **(6)** to select the **Reticle Color**  submenu.
2. Press the controller button **(6)** briefly to enter the Reticle Color submenu.

3. Rotate the controller ring **(6)** to select one of the color options for the reticle: Black/Red, White/Green, Yellow, Black/White, White/Red, Red, Blue, White/Black, Black/Green, Green, Orange
4. Press the controller button **(6)** briefly to confirm the selection.

Reticle Brightness

Adjust the brightness level of the aiming reticle.

1. Rotate the controller ring **(6)** to select the **Reticle Brightness**  submenu.
2. Press the controller button **(6)** briefly to enter the Reticle Brightness submenu.
3. Rotate the controller ring **(6)** to set the desired brightness level (1 to 10).
4. Press the controller button **(6)** briefly to confirm the selection.



Icon Brightness

Adjust the brightness level of the icons and screensavers (Pulsar, Display off) on the display.

1. Press and hold the controller button **(6)** to enter the main menu.
2. Rotate the controller ring **(6)** to select the **Icon Brightness**  menu item.
3. Press the controller button **(6)** briefly to enter the Icon Brightness submenu.
4. Rotate the controller ring **(6)** to set the desired brightness level (1 to 10).
5. Press the controller button **(6)** briefly to confirm the selection.

Wi-Fi Activation

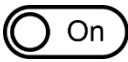
Turn on/off Wi-Fi

1. Press and hold the controller button **(6)** to enter the main menu.
2. Rotate the controller ring **(6)** to select the **Wi-Fi Activation**  menu item.
3. To turn Wi-Fi on, briefly press the controller button **(6)**. 
4. To turn Wi-Fi off, briefly press the controller button **(6)**. 

Calibration Mode

Calibration mode selection.

There are three calibration modes: **manual**, **semi-automatic** and **automatic**. The selected calibration mode is displayed in the status bar (see [Status Bar](#) section).

1. Press and hold the controller button **(6)** to enter the main menu.
2. Rotate the controller ring **(6)** to select the **Calibration Mode**  menu item.

3. Press the controller button **(6)** briefly to enter the Calibration Mode submenu.
4. Rotate the controller ring **(6)** to select one of the calibration modes described below.
5. Press the controller button **(6)** briefly to confirm your selection.

Automatic (A)

The software determines the need for calibration in automatic mode. The calibration process starts automatically.

Semi-automatic (SA)

The user independently determines the need for calibration (according to the image being observed).





Manual (M)

Manual calibration. Close the lens cover before starting calibration.

Zeroing

Add New Distance

To zero your riflescope, you need to set a zeroing distance first in the range of 1 to 910 m (955 yards).

1. Press and hold the controller button **(6)** to enter the main menu.
2. Rotate the controller ring **(6)** to select a menu item  and enter by briefly pressing the controller button.
3. Press the controller button **(6)** briefly to enter the **Add New Distance**  submenu.
4. Rotate the controller ring to select a value for each digit. Press the controller button **(6)** briefly to switch between digits  | 150 m .
5. Having set the desired distance, press and hold the controller button **(6)** to save it.

The distance you set first becomes a **primary distance** – shown with icon  on the right to the distance value.

Note: Maximum number of zeroing distances is ten for each profile.



Zeroing Parameters Settings

1. Press and hold the controller button **(6)** to enter the main menu.
2. Rotate the controller ring **(6)** to select the **Zeroing**  menu item and enter by briefly pressing the controller button **(6)** – the zeroed distances are displayed.
3. The values (e.g., +7.0) shown on the right of the distance values, stand for the number of clicks along the Y axis, at which the reticle position at other distances differs from the reticle position in the primary distance.
4. To zero at any distance again, rotate the controller ring **(6)** to select the required distance and briefly press the controller button **(6)**.

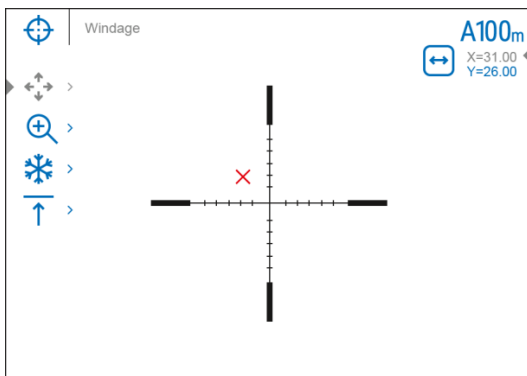
5. Rotate the controller ring **(6)** to select the **Zeroing Parameters Settings**  and enter by briefly pressing the controller button **(6)**.
6. **Zeroing** screen, which allows the change of zeroing coordinates, will appear.





Windage/Elevation

The **Windage/Elevation**  additional menu item in the **Zeroing Parameters Settings**  menu allows you to adjust the reticle position. For a detailed description of the reticle adjusting, refer to the **Zeroing** section.

Magnification





Magnification allows you to magnify a digital zoom of the riflescope when zeroing, which reduces the minute of angle click. It improves the zeroing accuracy.

1. In the **Zeroing Parameters Settings**  menu, rotate the controller ring **(6)** to select the **Magnification**  submenu item and enter by briefly pressing the controller button **(6)**.
2. Rotate the controller ring **(6)** to select a digital magnification value of the riflescope (e.g., x4).
3. Press the controller button **(6)** briefly to confirm your selection.

The minute of angle click when using the Magnification function is indicated in the Table of **Technical Specifications**.



Freeze

The feature of the function is that there is no need to constantly keep the riflescope at the point of aiming.



1. In the **Zeroing Parameters Settings**  menu, rotate the controller ring **(6)** to move the cursor to the **Freeze**  function.
2. Align the reticle with the point of aiming and press the controller **(6)** or **ON/OFF (3)** button. A screenshot will be taken, an icon  will appear.
3. Go to the additional **Windage/Elevation**  submenu and adjust the position of the reticle (see the **Zeroing** section).

4. Select the **Freeze**  submenu item again and briefly press the controller **(6)** or **ON/OFF (3)** button - the image will “unfreeze”.

Name Distance



1. In the **Zeroing Parameters Settings**  menu, rotate the controller ring **(6)** to select the **Name Distance**  submenu item and enter it by briefly pressing the controller button **(6)**.
2. Rotate the controller ring **(6)** to select a value for each digit. Press the controller button **(6)** briefly to switch between digits.
3. Press and hold the controller button **(6)** to confirm the selection.

Change Primary Distance

1. Press and hold the controller button **(6)** to enter the main menu.
2. Rotate the controller ring **(6)** to select the **Zeroing**  menu item and enter by briefly pressing the controller button **(6)** – the zeroed distances are displayed.
3. Select a non-primary distance and enter the submenu for operating the distance with a brief press of the controller button **(6)**.
4. Select **Change Primary Distance**  item.
5. Press the controller button **(6)** briefly.
6. Icon  next to the selected distance confirms the change of primary distance.

The differences of other distances from the new primary distance are recalculated as per clicks.

Delete Distance

1. Press and hold the controller button **(6)** to enter the main menu.
2. Rotate the controller ring **(6)** to select the **Zeroing**  menu item and enter by briefly pressing the controller button **(6)** – the zeroed distances are displayed.
3. Select the distance you wish to delete and enter the submenu for operating the distances with a brief press of the controller button **(6)**.
4. Select **Delete Distance**  item.
5. Press the controller button **(6)** briefly.
6. Select “Yes” in the appeared dialog box to delete a distance. “No” – to cancel deletion.
7. Press the controller button **(6)** briefly to confirm your selection.



Attention! If the primary distance is deleted, the first distance on the list automatically becomes the new primary distance.



Microphone

Turning on/off Microphone.

This item allows you to enable (or disable) the microphone for recording sound during video recording.

1. Press and hold the controller button **(6)** to enter the main menu.
2. Rotate the controller ring **(6)** to select the **Microphone**  menu item.

3. To turn on the microphone, briefly press the controller button **(6)**.  

4. To turn off the microphone, briefly press the controller button **(6)**.  

Color Modes

Color mode selection.

White hot is a default display mode for an observed image. The **Color Modes** menu item allows you to select an alternative palette:

1. Press and hold the controller button **(6)** to enter the main menu.
 2. Select the **Color Modes**  menu item.
 3. Press the controller button **(6)** briefly to enter the Color Modes submenu.
 4. Rotate the controller ring **(6)** to select one of the palettes described below.
 5. Press the controller button **(6)** briefly to confirm your selection.
- White hot – a black and white palette (the black color corresponds to cold temperature, the white color – hot temperature)
 - Black hot – a black and white palette (the white color corresponds to cold temperature, the black color – hot temperature)
 - Red hot
 - Red monochrome
 - Rainbow
 - Ultramarine
 - Violet
 - Sepia

Attention! The device does not measure the temperature of objects being observed. The image is formed based on the temperature differences of the objects.

General Settings

1. Press and hold the controller button **(6)** to enter the main menu.

2. Rotate the controller ring **(6)** to select the **General settings**  menu item.
3. Press the controller button **(6)** briefly to enter the submenu.
4. Rotate the controller ring **(6)** to select the desired menu item.

This menu item allows you to configure the following settings:

Language

Language selection:

1. Press the controller button **(6)** briefly to enter the **Language**  submenu.
2. Rotate the controller ring **(6)** to select one of the available interface languages: English, German, Spanish, French, Italian or Russian.
3. Confirm your selection with a short press of the controller button **(6)**.
4. Press and hold the controller button **(6)** to save your selection and exit from the submenu.

Date

Date Setting:

1. Press the controller button **(6)** briefly to enter the **Date**  submenu. The date is displayed in dd/mm/yyyy format.
2. Rotate the controller ring **(6)** to select the desired year, month and date. Press the controller button **(6)** briefly to switch between digits.
3. Press and hold the controller button **(6)** to save your selected date and exit from the submenu.

Time

Time Setting:

1. Press the controller button **(6)** briefly to enter the **Time**  submenu.
2. Rotate the controller ring **(6)** to select the time format - 24 or AM/PM.
3. Press the controller button **(6)** to proceed to the hour setting.
4. Rotate the controller ring **(6)** to select the hour value.
5. Press the controller button **(6)** to proceed to the minute setting.
6. Rotate the controller ring **(6)** to select the minutes value.
7. Press and hold the controller button **(6)** to save your selected time and exit from the submenu.

Units of Measure

Units of measurement selection:

1. Press the controller button **(6)** briefly to enter the **Units of Measure**  submenu.
2. Rotate the controller ring **(6)** to select the unit of measurement - meters or yards, press the controller button **(6)**.
3. Return to submenu will happen automatically.

Default Settings

1. Press the controller button **(6)** briefly to enter the **Default Settings**  submenu.
2. Rotate the controller ring **(6)** to select “Yes” to restore default settings or “No” to cancel the action.
3. Confirm your selection with a short press of the controller button **(6)**.
 - If “Yes” is selected, display will show “Do you want to restore default settings?” and “Yes” and “No” options. Select “Yes” to restore default settings.
 - If “No” option is selected: the action will be aborted and you will return to the submenu.

The following settings will be returned to their defaults:

Video Recorder Mode – Video	Wi-Fi – off (default password)	Units of Measurement – metric
Observation Mode – Forest	Magnification – initial value	Side Incline – Off
Calibration Mode – automatic	PiP – off	Weapon Profile – A
Interface Language – English	Color Mode – White hot	Reticle selection from the riflescope’s memory – 1

Attention! After restoring default settings, the date, time and user pixel map as well as the zeroing profiles data entered by the user are saved.

Format

This menu option allows you to format the device's memory card. All files will be deleted.

1. Press the controller button **(6)** briefly to enter the **Format**  submenu.
2. Rotate the controller ring **(6)** to select “Yes” to format the memory card, or “No” to return to the submenu.
3. Confirm your selection by pressing the controller button **(6)**.
 - If the “Yes” option has been selected, the "Do you want to format memory?" message and “Yes” and “No” options will appear on the display. Select “Yes” to format the memory card.
 - If “No” option is selected: formatting is cancelled and return to the submenu.

Wi-Fi Settings

This item enables you to set up your riflescope for operation in a Wi-Fi network.

1. Press and hold the controller button **(6)** to enter the main menu.
2. Rotate the controller ring **(6)** to select the **Wi-Fi Settings**  submenu.
3. Press the controller button **(6)** briefly to enter the submenu
4. Rotate the controller ring **(6)** to select the desired menu item.

Password Setup

This item enables you to set a password to access the riflescope from an external device. The password is used to connect an external device (i.e. smartphone) to the riflescope.

1. Press the controller button **(6)** to enter the **Password Setup**  submenu.
2. The default password (12345678) will appear on the screen.
3. Rotate the controller ring **(6)** to set the desired password. Press the controller button **(6)** to toggle through the digits.
4. Press and hold the controller button **(6)** to save the password and exit from the submenu.

Access Level Setup

This sub-function enables you to configure the appropriate level of access to your device made available to the Stream Vision application.

Owner level. A Stream Vision user has full access to all the device's functions.



Guest level. A Stream Vision user can only view video footage from the device in real time.

1. Press the controller button **(6)** to enter the **Access Level Setup**  submenu.
2. Rotate the controller ring **(6)** to select **Owner** or **Guest**.
3. Confirm your selection with a short press of the controller button **(6)**.

Accelerometer

Auto Shutdown

This item allows you to activate auto shutdown function for riflescope in a non-operating position (tilt up or down at an angle of more than 70°, right or left - at an angle of more than 30°). In this event, the controls (buttons, controller) are disabled.

1. Press and hold the controller button **(6)** to enter the main menu.
2. Rotate the controller ring **(6)** to select the **Accelerometer**  submenu.
3. Confirm the selection by briefly pressing the controller **(6)**.
4. Rotate the controller ring **(6)** to select **Auto Shutdown** .
5. Press the controller button **(6)** briefly to enter the submenu.
6. Rotate the controller ring **(6)** to select the time period **(1 min, 3 min, 5 min)** upon expiry of which the riflescope will automatically shut down, or select **Switch off** if you wish to deactivate Auto Shutdown.
7. Confirm your selection with a short press of the controller button **(6)**.

Note: If the automatic shutdown function is activated, the status bar shows an icon and shutdown time period as  1 min.

Side Incline

This item allows you to turn on/off the indication of horizontal (side) incline of the weapon. Side incline is indicated by “sector” arrows to the right and left of the reticle. Arrows show the direction in which you should move your rifle to eliminate incline.

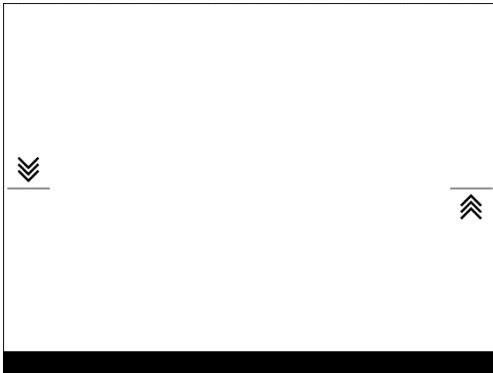

There are three modes of incline:

- 5°-10 ° – one sector arrow;
- 10°-20 ° - two sector arrow;
- > 20° - three sector arrow.

A side incline of less than 5° is not displayed.

1. Press and hold the controller button **(6)** to enter the main menu.
2. Rotate the controller ring to select the **Accelerometer ((•))** menu item.
3. Press the controller button **(6)** briefly to enter the Accelerometer submenu.
4. Rotate the controller ring to select **Side Incline →←**.
5. Press the controller button **(6)** briefly to enter the Side Incline submenu.
6. Rotate controller ring to select On for turning on the incline indication or Off for turning it off.
7. Confirm your selection with a short press of the controller button **(6)**.

Defective Pixel Repair





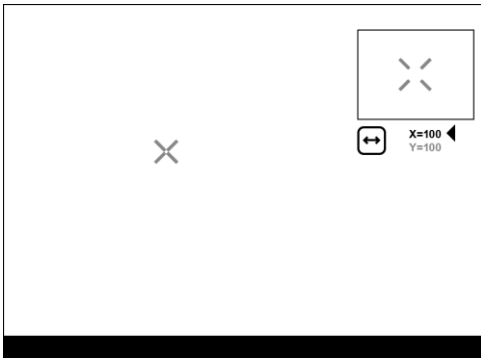

Defective Pixel Repair

When using the device, defective (dead) pixels may appear on the microbolometer. These are bright or dark points of a constant brightness that are visible on the image.

Defective pixels on the microbolometer can increase in size relatively when digital zoom is activated.



Thermion 2 riflescopes offer the possibility of removing any defective pixels on the microbolometer using software, as well as to cancel any deletion.



1. Press and hold the controller button **(6)** to enter the main menu.
2. Rotate the controller ring **(6)** to select the **Defective Pixel Repair**  menu item.
3. Press the controller button **(6)** to open the submenu.
4. Press the controller button **(6)** briefly to select the icon .
5. A marker  will appear on the left side of the display. A “magnifying glass” will appear on the right side of the display — a rectangle with an enlarged view of the marker  for precise pixel selection — and marker coordinates under the “magnifying glass”  **X=100**  **Y=100**.
6. Rotate the controller ring **(6)** to move the marker to align its center with the defective pixel.
7. Press the controller button **(6)** shortly to switch the marker direction from the horizontal to the vertical and vice versa.
8. Rotate the controller ring **(6)** to align the defective pixel with the fixed cross in the frame – the pixel should disappear.
9. Delete the defective pixel with a short press of the **ON/OFF (3)** button.
10. Where the pixel has been successfully deleted, the OK message will appear on the screen for a short time.
11. Then, by moving the marker across the display, you can delete the next defective pixel.
12. Press and hold the controller button **(6)** to exit the Defective Pixel Repair function.

Restore Default Pixel Map

This option allows the user to return all previously disabled defective pixels to their original state.

1. Press and hold the controller button **(8)** to enter the main menu.
2. Rotate the controller ring **(8)** to select the **Defective Pixel Repair**  icon.
3. Press the controller button **(8)** to enter the submenu.
4. Rotate the controller ring **(8)** to select the **Restore Default Pixel Map**  icon.
5. Activate the function by briefly pressing the controller button **(8)**.

6. Rotate the controller ring **(8)** to select **Yes** if you want to return to the factory pixel map or select **No** if you do not.
7. Confirm your selection with a short press of the controller button **(8)**.

Attention! One or two pixels on the display of the device in the form of bright white, black or colored (blue, red or green) points may appear. These points cannot be removed and are not a defect.

Device Information

1. Press and hold the controller button **(6)** to enter the main menu.
2. Rotate the controller ring **(6)** to select the **Device Information**  menu item.
3. Press the controller button **(6)** briefly to enter the **Device Information** submenu.

This item allows the user to view the following information about the riflescope:



- Full name of the riflescope
- SKU number
- Serial number of the riflescope
- Riflescope firmware version
- Hardware version
- Service information
- Battery information

Video Recording and Photography

The riflescope is equipped with a function for video recording (photography) of the observed image that is saved on the built-in memory card.

Before using the photo and video functions, read the **Date** and **Time** subsections of the [General Settings](#) section.

Built-in recorder operates in two modes:

- **Photo** (photography; the icon  is displayed in the upper left corner of the display).
- **Video** (video recording; the icon  is displayed in the upper right corner of the display, the total remaining recording time is given taking into account the current resolution in the HH:MM format (hours:minutes).

Toggle (switch) between the riflescope operating modes with a long press of the **REC (4)** button. Switching between the modes is cyclical (Video→ Photo→ Video...).

Photo mode. Capturing an image

1. Switch to **Photo** mode with a long press of the **REC (4)** button.

2. Press the **REC (4)** button briefly to capture a photo. The image freezes for 0.5 sec - a photo is saved to the internal memory.

Video mode. Recording a video

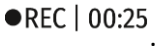
1. Switch to the **Video** mode with a long press of the **REC (4)** button.
2. Press the **REC (4)** button briefly to start video recording.
3. When the video recording starts, the icon  will disappear, instead of it the **REC** icon as well as the video recording timer displayed in the MM:SS (minutes:seconds) format will appear  .
4. Pause/continue recording by briefly pressing the **REC (4)** button.
5. Press and hold the **REC (4)** button to stop video recording.
6. Video files are stored in the built-in memory card:
 - After turning off the video recording;
 - Upon powering the riflescope off if recording was on;
 - When the memory card is overfilled during recording (Memory Full message appears on the display).

Notes:

- You can enter and navigate the menu during video recording.
- Recorded videos and photos are saved to the built-in memory card of the riflescope in the format img_xxx. jpg (for photos); video_xxx. mp4 (for video). xxx – three-digit counter (for videos and photos);
- The counter used for the names of multimedia files cannot be reset;
- If a file is deleted from the middle of the list, its number is not taken by the other file;
- When the counter is full, a new folder is created: img_xxxx; xxxx being a file counter;
- Maximum duration of a recorded video file is 5 minutes. After this time expires, the video is recorded to a new file. The number of recorded files is limited by the capacity of unit's internal memory;
- Regularly check free memory within the built-in memory card and move the footage to other storage media to free up the memory card space.





Wi-Fi Function



The riflescope has a function for wireless communication with mobile devices (smartphone or tablet) via Wi-Fi.

1. To enable the wireless module, enter the main menu by long pressing the controller button **(6)**.
2. Rotate the controller ring **(6)** to select the **Wi-Fi Activation**  menu item.

3. Press the controller button **(6)** briefly to turn on/off the Wi-Fi module.

Wi-Fi is displayed in the status bar as follows:

Connection Status	Indication in the Status Bar
Wi-Fi is switched off	
Wi-Fi is switched on by the user, Wi-Fi connection in the riflescope is in progress.	
Wi-Fi is switched on, there is no connection to the riflescope	
Wi-Fi is switched on, there is connection to the riflescope	

- An external device recognizes the riflescope under the name Thermion2_XXXX, where XXXX are the four last digits of the serial number.
- After entering the password (**default: 12345678**) on a mobile (see **Password Setup** subsection of the [Wi-Fi Settings](#) section for more information on setting a password) and setting up a connection, the icon  in the riflescope status bar changes to .
- Launch Stream Vision application on your mobile device (see [Stream Vision](#) section).
- Video broadcasting on a mobile screen starts after the viewfinder button on the mobile screen is activated.

Stadiametric Rangefinder



Thermal imaging riflescopes are equipped with a stadiametric rangefinder, which allows you to determine the approximate distance to an object, if its size is known.



1. To select the **Stadiametric Rangefinder** function, enter the [Quick Menu](#) by briefly pressing the controller button **(6)**.
2. Press the controller button **(6)** briefly to select the icon .
3. The display will show the lines for measurements, the icons and numbers of the measured distance for three objects.

4. Place the bottom fixed line under the object.
5. Rotate the controller ring **(6)** to move the upper line relative to the lower horizontal fixed line so that the object is located directly between the lines. A target range automatically recalculated along with movement.
6. To exit the rangefinder mode, briefly press the controller button **(6)** or wait 10 seconds to exit automatically.

Notes:

- There are three predefined values for objects: Hare – 0.3 m high, Boar – 0.7 m high, Deer – 1.7 m high.
- The measured range value is rounded off before being displayed – for large range values up to 5 m, for shorter range – up to 1 m.
- To select a unit of measurement (meters or yards), go to the [General Settings](#)  menu item => **Units of Measure**  submenu.

Display Off Function

This function deactivates the image transmission to the display by minimizing its brightness. This helps prevent accidental disclosure. However, the device stays on.

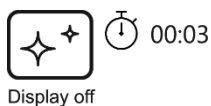

Options for operating with the Display Off function:

Option 1. Riflescope off. It is necessary to power the riflescope on and activate the Display Off function.

1. Press the **ON/OFF (3)** button briefly to power the riflescope on.
2. Activate the Display Off function: press and hold the **ON/OFF (3)** button. The Display Off message with a countdown will appear on the screen.
3. Release the **ON/OFF (3)** button.
4. Press the **ON/OFF (3)** button briefly to deactivate the Display Off function (to activate the display).

Option 2. The Display Off function is activated; the riflescope should be turned off.

1. Press and hold the **ON/OFF (3)** button. Display Off message with 3, 2, 1 countdown will appear on the screen.
2. Hold the **ON/OFF (3)** button until the riflescope turns off (the riflescope turns off after counting up to 1).

PiP Function

The PiP function (Picture-in-Picture) allows you to see both a magnified image in a particular dialog box and the main image.

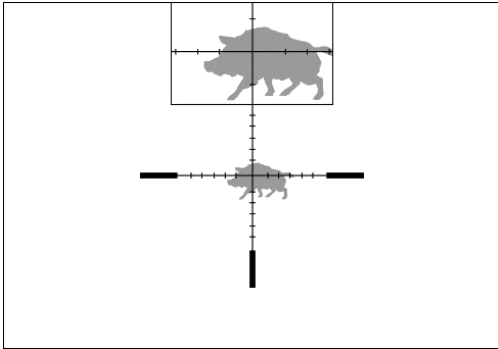

1. Press and hold the **ZOOM (5)** button to turn on/off the PiP function.
2. To change digital magnification in the PiP window, rotate the controller ring **(6)**, while the icon  is visible on the screen.
3. The magnified image is displayed in a particular dialog box, with the full magnification being used.
4. The rest of the image is displayed only with the optical zoom (digital zoom is off).
5. When PiP is turned off, the display shows the full magnification set for the PiP mode.

Stream Vision



Thermion 2 thermal imaging riflescopes support Stream Vision technology which allows you to stream an image from the display of your thermal imager to a smartphone or tablet PC via Wi-Fi in real time mode.

You can find further guidelines on Stream Vision here: <https://www.pulsar-nv.com/glo/products/33/software-applications/stream-vision/>

Firmware Update

1. Download free of charge Stream Vision App on [Google Play](#) or [App Store](#).
2. Connect your Pulsar device to your mobile device (smartphone or tablet).
3. Launch Stream Vision and go to section "My Devices".
4. Select your Pulsar device and press "Check Updates".

5. Wait for the update to download and install. Pulsar device will reboot and will be ready to operate.

Important:

- if your Pulsar device is connected to phone, please turn on mobile data transfer (GPRS/3G/4G) to download update;
- if your Pulsar device is not connected to your phone but it's already in the "My Devices" section, you may use Wi-Fi to download update.

Is your firmware up to date?

Click [here](#) to check the latest firmware for your device.

USB Connection

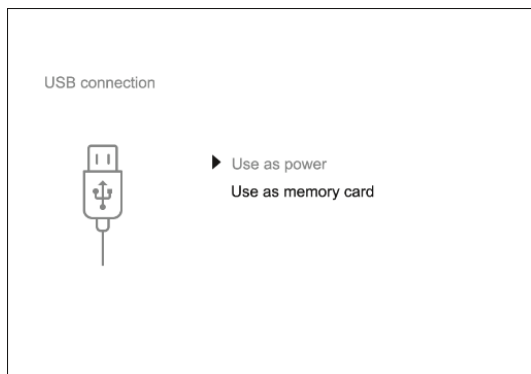

1. Press the **ON/OFF (3)** button briefly to power the riflescope on (the computer will not detect the riflescope if it is turned off).
2. Connect one end of the USB cable to the riflescope micro USB port (**10**) and the other one to the port on your computer.
3. The riflescope is detected by the computer automatically and no installation of drivers is required.
4. After a few seconds, two connection options appear on the display: **Power** and **Memory card**.
5. Rotate the controller ring (**6**) to select the connection mode.
6. Press the controller button (**6**) briefly to confirm your selection.

Connection Options:

Power

- Upon choosing this mode, your PC is used as an external power supply. An icon  will appear in the status bar.
- The riflescope continues operating and all functions are accessible.
- The Battery Packs installed in the riflescope are not charged.

Memory Card

- When selecting this mode, the computer recognizes the riflescope as a memory card. This mode is designed to manage the files saved in riflescope's memory.

- The riflescope's functions are not available in this mode; the riflescope turns on. The device continues to operate after being disconnected from the computer.
- If a video was being recorded at the moment of connection, the recording will stop and will be saved.

USB Disconnection:

- When the USB is disconnected from the riflescope connected in the **Power** mode, the riflescope continues to operate on battery packs when they are sufficiently charged.
- When the USB is disconnected from the riflescope connected in the **Memory Card** mode, the riflescope remains switched on.

Technical Inspection

It is recommended to carry out a technical inspection each time before using the riflescope. Check the following:

- The riflescope appearance (there should be no cracks on the body).
- The condition of the lens and eyepiece (there should be no cracks, greasy spots, dirt or other deposits).
- The state of the battery pack (must be charged to a level of 50-70%) and the electric contacts within it (there should be no signs of salts or oxidation).
- The controls should be in working order.

Technical Maintenance

The maintenance should be carried out at least twice a year and includes the following steps:

- Wipe the exterior surfaces of metal and plastic parts off dust and dirt with a cotton cloth. Silicone grease may be used for this.
- Clean the electric contacts of the battery pack and battery slots on the riflescope using a non-greasy organic solvent.
- Check the optics of the eyepiece and the lens. If necessary, remove dust and sand from the optics (it is preferable to use a non-contact method). Cleaning of the exterior surfaces of the optics should be done with cleaners designed especially for this purpose.

Troubleshooting

The device does not turn on

Possible cause

The Battery Pack is empty

Solution

Charge the battery pack

The device does not operate from an external power source

Possible cause

USB cable is damaged.

Solution

Replace USB cable.

Possible cause

The external power supply is discharged.

Solution

Charge the external power supply.

The image is fuzzy. There are distortions in the form of bars of different widths lying in different directions, or dots of different size and brightness.

Possible cause

Calibration is required.

Solution

Perform image calibration according to [Microbolometer Calibration](#) section.

Black screen after calibration

Solution

If the image does not clear after calibration, you need to recalibrate.

The reticle is blurred and cannot be focused with the dioptre ring

Possible cause

The diopter adjustment range is not enough for your eyesight.

Solution

If you wear glasses with a range of +3/-5, keep glasses on when looking through the eyepiece.

Coloured lines appeared on display or image has disappeared

Possible cause

The device was exposed to static electricity during operation.

Solution

After exposure to static electricity, the device may either reboot automatically, or require turning off and on again.

The image is too dark

Possible cause

Brightness or contrast level is too low.

Solution

Adjust the brightness or contrast in the [Quick Menu](#).

With a crisp image of the reticle, the image of the observed target that is at least 30 m away is blurred

Possible cause

Dust and condensate are covering the outside or inside optical surfaces.

Solution

Wipe the outside optical surfaces with a soft cotton cloth. Let the riflescope dry by leaving it in a warm environment for 4 hours.

Possible cause

The lens is not focused.

Solution

Adjust the image sharpness by rotating the lens adjuster.

The aiming point shifts after firing rounds

Possible cause

The riflescope is not mounted securely or the mount was not fixed with thread sealant.

Solution

Check that the riflescope has been securely mounted.

Make sure that the same type and calibre bullets are being used as when the scope was initially zeroed.

If your riflescope was zeroed during the summer, and is now being used in the winter (or the other way round), in the day or night, a slight shift of the aiming point is possible.

The riflescope will not focus

Possible cause

Wrong settings.

Solution

Adjust the riflescope according to the [Powering On and Image Setting](#) section. Check the outer surfaces of the objective lenses and eyepiece and, where necessary, wipe them from dust, condensation, frost, etc. In cold weather, you can use special anti-fogging coatings (e.g., the same as for corrective glasses).

Smartphone or tablet cannot be connected to the device

Possible cause

Password in the riflescope was changed.

Solution

Delete network and connect again inserting the password saved in the riflescope.

Possible cause

There are too many Wi-Fi networks in the area where the riflescope is located which may cause signal interference.

Solution

To ensure stable Wi-Fi performance, move the riflescope to an area with few or no Wi-Fi networks.

Wi-Fi signal is missing or interrupted

Possible cause

Smartphone or tablet is out of range of a strong Wi-Fi signal. There are obstacles between the device and the smartphone or tablet (e.g., concrete walls).

Solution

Relocate smartphone or tablet into the Wi-Fi signal line of sight.

The image of the object being observed is missing

Possible cause

Observation through glass.

Solution

Remove the glass from the field of vision.

Poor image quality/ Reduced detection distance

Possible cause

These problems may occur during the observation in adverse weather conditions (snow, rain, fog etc.).

There are several light or black dots (pixels) on riflescope's display or microbolometer

Solution

The presence of dots is caused by peculiarities of microbolometer or display production technology and is not a defect.

When the device is used in low temperature conditions the image quality is worse than in positive temperatures.

Possible cause

In positive temperature conditions, objects being observed (surroundings and background) heat up differently because of thermal conductivity, thereby generating a high temperature contrast. Consequently, the image quality produced by the thermal imager will be better.

In low-temperature conditions, objects being observed (background) will cool down to roughly the same temperature, which leads to a greatly reduced temperature contrast and a degraded image quality. This is normal for all thermal imaging devices.

Legal Compliances and Disclaimers

Attention! Thermion 2 thermal imaging riflescopes require a licence when exported outside your country.

Electromagnetic compatibility. This product complies with the requirements of European standard EN 55032: 2015, Class A.

Caution: Operating this product in a residential area may cause radio interference.

Improvements may be made to the design of this product to enhance its user features.

Repair of the device is possible within 5 years.

