

Sylvox

24inch RV TV

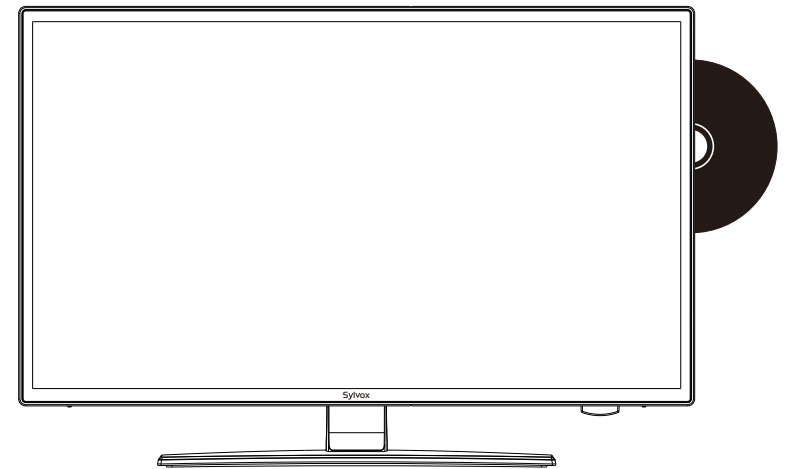

Model: RT24R2GNDA

USER'S MANUAL

Note: The product and illustrations in this user's manual is only for explanation purposes and may vary depending on model.

Safety Information

To avoid damaging the television set please observe the following safety instructions during setup and use.

Attaching to a wall mount	Please ensure that the screws (M4) project into the television set by no more than 8 mm. The use of longer screws can damage the television set.
Cleaning the television set	Before cleaning, disconnect the television set. Use only a soft damp cloth or a special cleaning product for flat-screens.
LED Display	Too much pressure on the screen can damage the television set.
Heat/damp/humidity	The television set should not be exposed to high temperatures (direct sunlight, radiators, open fire) or to damp. The television set should not be used in areas with high humidity.
Condensation	If moved from a cool area to one with a higher temperature, the television set should be left for at least an hour before plugging it in. A rapid change of temperature can lead to the formation of condensation in the television set itself. This can lead to damage if the television set is in use.
Air Circulation	To prevent overheating of the television set the ventilation slots at the rear should always be clear.
Small Objects	It is important to ensure that no small objects or liquids enter the television set. They can cause damage or even fire.
Liquids/Candles	Do not place anything holding a liquid or any candles on the television set.
Crushing	Take care to avoid crushing fingers or other objects when turning the television set in any direction.
Electric Supply	Use the television set only with the voltage indicated in the specifications. Ensure that there is easy access to the plug and that the television set can always be disconnected from the electricity supply. Do not disconnect the television set by pulling the power cable. Always take hold of the plug. The power cable must not be kinked or placed over sharp edges.
Moving the Television Set	When moving the television set, hold only the casing.
Repairs/Accessories	Repairs and servicing must be undertaken only by authorised and trained personnel.
Recycling	In accordance with the Batteries Regulation, batteries are to be disposed of only in containers provided for this purpose.

Safety Information



In extreme weather (storms, lightning) and long inactivity periods (going on holiday) disconnect the TV set from the mains. The mains plug is used to disconnect TV set from the mains and therefore it must remain readily operable. If the TV set is not disconnected electrically from the mains, the device will still draw power for all situations even if the TV is in standby mode or switched off.

IMPORTANT - Please read these instructions fully before installing or operating

WARNING: Never let people (including children) with reduced physical, sensory or mental capabilities or lack of experience and / or knowledge use electrical devices unsupervised.

The TV set is intended for household and similar general use but may also be used in public places.

For ventilation purposes, leave at least 5cm of free space around the TV.

The ventilation should not be impeded by covering or blocking the ventilation openings with items, such as newspapers, table-cloths, curtains, etc.

The power cord plug should be easily accessible. Do not place the TV, furniture, etc. on the power cord. A damaged power cord/plug can cause fire or give you an electric shock. Handle the power cord by the plug, do not unplug the TV by pulling the power cord. Never touch the power cord/plug with wet hands as this could cause a short circuit or electric shock. Never make a knot in the power cord or tie it with other cords. When damaged it must be replaced, this should only be done by qualified personnel.

Do not expose the TV to dripping or splashing of liquids and do not place objects filled with liquids, such as vases, cups, etc. on or over the TV (e.g., on shelves above the unit).

Do not expose the TV to direct sunlight or do not place open flames such as lit candles on the top of or near the TV.

Do not place any heat sources such as electric heaters, radiators, etc. near the TV set.

Do not place the TV on the floor and inclined surfaces.

To avoid danger of suffocation, keep plastic bags out of the reach of the babies, children and domestic animals.

Carefully attach the stand to the TV. If the stand is provided with screws, tighten the screws firmly to prevent the TV from tilting. Do not over-tighten the screws and mount the stand rubbers properly.

Do not dispose of the batteries in fire or with hazardous or flammable materials.

Warning: Batteries must not be exposed to excessive heat such as sunshine, fire or the like.

Safety Information

WARNING

Do not ingest the battery, Chemical Burn Hazard This product or the accessories supplied with the product may contain a coin/button cell battery. If the coin/button cell battery is swallowed, it can cause severe internal burns in just 2 hours and can lead to death.

Keep new and used batteries away from children.

If the battery compartment does not close securely, stop using the product and keep it away from children.

If you think batteries might have been swallowed or placed inside any part of the body, seek immediate medical attention.

WARNING

Never place a television set in unstable or inclined locations. A television set may fall, causing serious personal injury or death. Many injuries, particularly to children, can be avoided by taking simple precautions such as;

Using cabinets or stands recommended by the manufacturer of the television set.

Only using furniture that can safely support the television set.

Ensuring the television set is not overhanging the edge of the supporting furniture.

Not placing the television set on tall furniture (for example, cupboards or bookcases) without anchoring both the furniture and the television set to a suitable support.

Not standing the television set on cloth or other materials placed between the television and supporting furniture.

Educating children about the dangers of climbing on furniture to reach the television set or its controls. If your existing television set is being retained and relocated, the same considerations as above should be applied.



The terms HDMI and HDMI High-Definition Multimedia Interface, and the HDMI logo are trademarks or registered trademarks of HDMI Licensing LLC in the United States and other countries.

Table of Contents

Introduction	
Features	3
Accessories	3
Specifications	4
General Description	
Overview of front and side panel	5
Base bracket guide	6
Overview of back panel	7
Overview of remote control	8
Installing Batteries in the Remote Control	9
Antenna connection	
External Connection	
Connecting VCR	10
Connecting DVD Player/Set-Top Box	11
Connecting Digital Audio System	12
Connecting DVD Player/Set-Top Box via HDMI	13
Connecting PC	14
Supporting signals	
Basic operation	
Turning the TV On and Off	15
TV QUICK INSTALLATION GUIDE	16

Table of Contents

OSD Menu Operations	
Picture	17-18
Sound	19
Time	20
Setup	21
Lock	22-26
Channel	27
FM	28-29
DVD Setup Menu	30-32
Troubleshooting	33
Picture defects and the reason	34

Introduction

Features

Input terminals used for external equipment connection

One Computer VGA/PC input	One PC Audio input
One AV input	One HDMI input
One EARPHONE output	One USB input
One ANTENNA input	One YPbPr input
One COAXIAL output	One L/R Audio output

Accessories

Please make sure the following items are included with your LED TV. If any items are missing, contact your dealer.



Remote Control

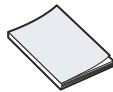

Instructions Manual



Adapter



Power Cord

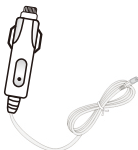

Car charger cable



Column bracket

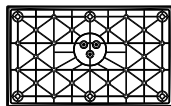

Base

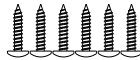

6 Screws

Introduction

Specifications

Model	RT24R2GNDA
Display Size	24"
Display Screen Type	LED
Power adaptor	DC 12V $\overline{\text{---}}$ 4A
The maximum resolution	1920 X 1080
Power Consumption(Max)	32W
Sound output(Max)	2 x 5W
Image control	Fine digital control
Display screen type	Color active matrix LED display
TV receive system	NTSC System, ATSC System
Frequency range	Antenna: 2~69; Cable: 1~135 (Analog: 1-125, Digital: 1-135)
Video IN	NTSC3.58
Antenna input impedance	75 Ω (Unbalance)
Product Dimensions (Include base bracket)	21.7 x 6.5 x 14.0 inch
Wall mount	VESA 100 x 100
Weight (Net weight)	7.1 lbs
Operation environment temperature	0 $^{\circ}$ C-40 $^{\circ}$ C

Remarks:

The above listed specifications and data are subject to change without prior notice.

General Description

Overview of front and side panel

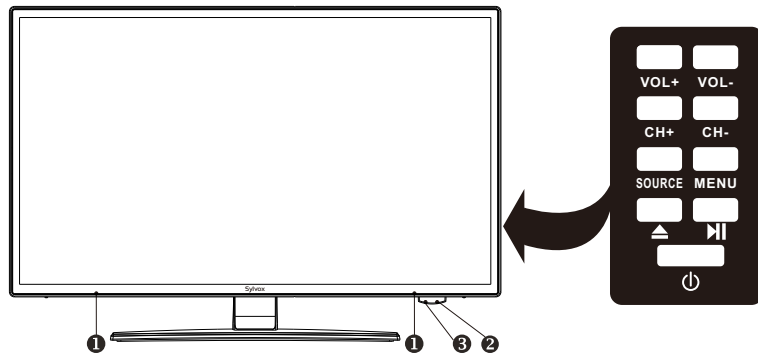

- | | |
|--|--|
| <p>1 SPEAKER</p> <p>2 REMOTE CONTROL SENSOR</p> <p>3 POWER INDICATOR
Green: In power on mode.
Red: In standby mode.</p> <p>4 SOURCE
Toggles between all the available input sources</p> <p>5 MENU
Press to see an on-screen menu of your TV's features.</p> <p>6 CH+/-
Press to change channels.
In the on-screen menu, use the CH +/- buttons as up/down arrow buttons.</p> | <p>7 VOL+/-
Press to increase or decrease the volume.
In the on-screen menu, use the VOL +/- buttons as left/right arrow buttons.</p> <p>8 PLAY /
Play/stop DVD (in DVD mode).</p> <p>9 EJECT /
Eject DVD.</p> <p>10 POWER /
Press POWER button to toggle between normal and standby mode.</p> |
|--|--|

Introduction

Base bracket guide

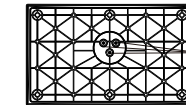
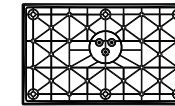
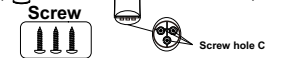
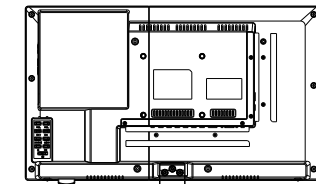
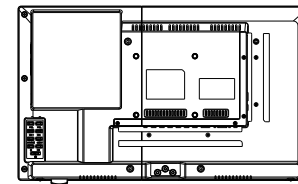
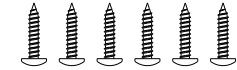
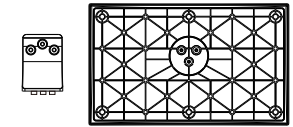
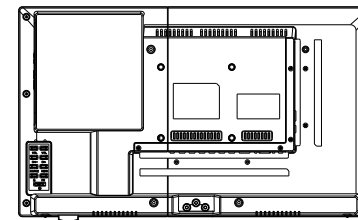

1
2

3
4

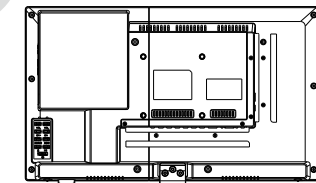
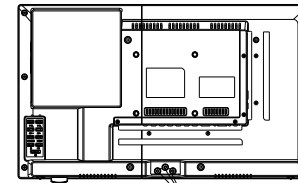

Instruction:

1. Place the TV unit on a flat and clean table.
2. Fix stand by 3 pcs screws via screw hole B and A.
3. Fix stand by 3 pcs screws via screw hole D and C.

General Description

Overview of back panel

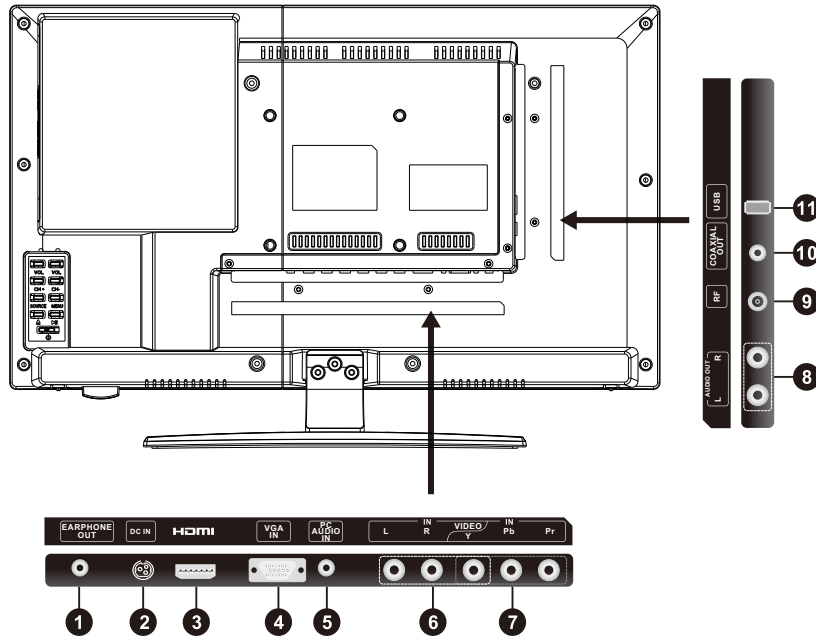

1. EARPHONE

Connect a set of phone for private listening.

2. POWER(DC 10.5-28V) input

3. HDMI

Connect a device with a HDMI input.

4. VGA/PC IN

Connect to your PC.

5. PC AUDIO

Audio input for external devices.

6. COMPOSITE VIDEO

Video input for external devices, such as a camcorder or VCR.

7. YPbPr

Connecting for the Y/Pb/Pr Input in Component mode.

8. L/R AUDIO output

Audio outputs for external devices.

9. RF

Connect to an antenna or cable NTSC & ATSC.

10.COAXIAL

Connect to a Digital Audio devices.

11.USB Service port.

General Description

Overview of remote control



POWER: Power on/off button, press once to turn the TV on and press again to turn the TV off.
MUTE: Press this button to mute or restore sound.
0-9: Select and switch to a channel using 0-9.
-/-: Switch the program digit.
↔: Switch back and front between the current and previous channels.
DISPLAY: Display TV information.
EPG: Enter electronic program guide.
AUTO: Adjust the picture automatically in pc mode.

SLEEP: Set the sleep timer.
SOURCE: Press to change signal source.
ENTER: Enter the selected option or perform the selected operation.
MENU: Press this button to enter the main menu.
EXIT: Exit the OSD (On-screen display).
FAV: Switch between custom set "Favorite List"
F.LIST: Press this key to display the Favorite List mode.
C.LIST: Press this key to display the channel list mode.
CH+/CH-: Change the channel.
VOL+/VOL-: Adjust the volume.
MTS/AUDIO: When stereo program is received, press this key to switch sound system between mono and stereo. When SAP program is received, press this button to switch sound system between mono and SAP. When stereo and SAP program is received, press this key to switch among mono, stereo and SAP. Press this key to show the list of audio languages available for the current channel in ATSC.
ASPECT: Press to adjust picture ratio.
PMODE: Select picture mode.
SMODE: Select sound mode.

▲: Open/close in DVD mode.
SETUP: DVD system setup.
DISP: Press to display the programs' information.
AUDIO: Press to change the language of the audio in DVD mode.
GOTO: Press this button to go to desired position The player provides 3 search mode.
SUBTITLE: Press to select the subtitle language.
REPEAT: Press to change the playing mode.
CC: Press this key to select the CC, ON or Off mode and CC on Mute.
TITLE: Press this button can return to the title of the disc.
MENU PBC: Press this button can return to the menu of the disc, then play the disc from the first track.
⏸: Play / Pause.
■: Stop playing.
⏮ ⏭: Play previous / next media file.
⏪ ⏩: Play fast backward / forward.
A-B: Repeat play the segment between A and B.

General Description

Installing Batteries in the Remote Control

Installing Batteries

- 1 Open the battery compartment cover on the back side.

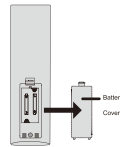

- 2 Insert two 1.5V AAA size batteries in correct polarity. Don't mix old or used batteries with new ones.

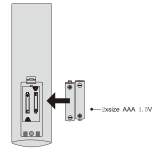

- 3 Closed the cover.

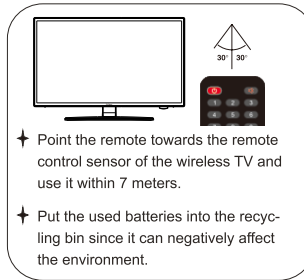
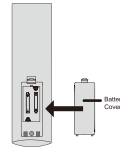

Note:

- One loading of batteries will last for 1 year under normal use
- If you do not intend to use the remote controller for a long period of time, remove them to avoid damage due to leakage.
- Do not use old and new batteries together.
- The battery (battery or batteries or battery pack) shall not be exposed to excessive heat such as sunshine, fire or the like.

External Connection

Antenna connection

Antenna input impedance of this unit is 75ohm. VHF/UHF 75ohm coaxial cable can be connected to the antenna jack directly, if the antenna cable is 300ohm parallel flat feeder cable, you need to use the 300ohm/75ohm converter to connect the antenna cable to the antenna jack. For details Please refer to the following drawing.

Antennas with 300 ohm flat twins Leads

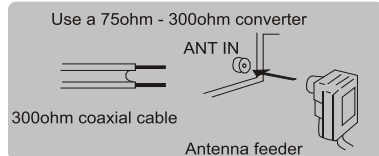

Antennas with 75 ohm Round Leads

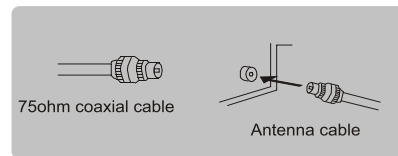

External Connection

Connecting VCR

These instructions assume that you have already connected your TV to an antenna or a cable TV system. Skip step 1 if you have not yet connected to an antenna or a cable system.

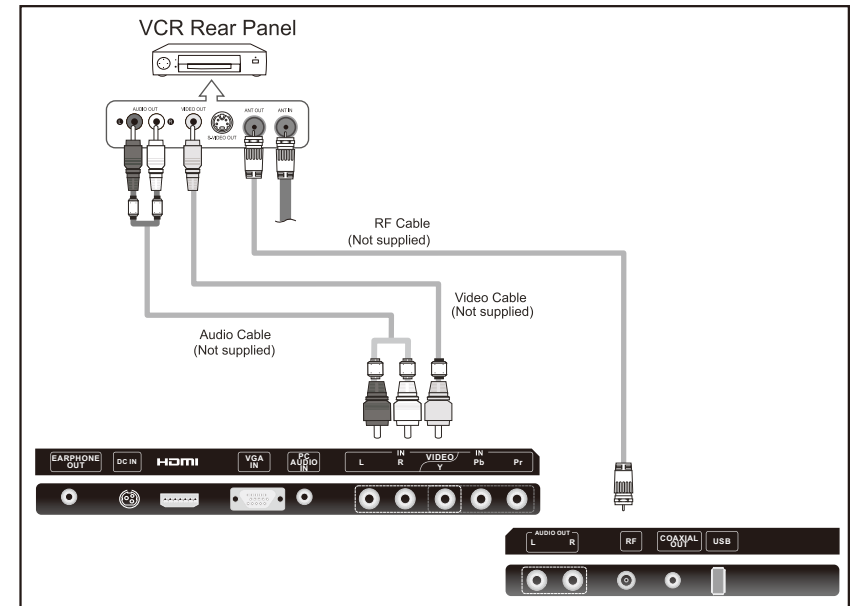

Follow the instructions in Viewing a VCR or Camcorder Tape to view your VCR tape. Each VCR has a different back panel configuration.

When connecting a VCR, match the color of the connection terminal to the cable. We recommend the use of cables with a Ferrite Core.

1. Unplug the cable or antenna from the back of the TV.
2. Connect the cable or antenna to the ANT IN terminal on the back of the VCR.
3. Connect an RF Cable between the ANT OUT terminal on the VCR and the ANT IN terminal on the TV.
4. Connect a Video Cable between the VIDEO OUT jack on the VCR and the VIDEO IN jack on the TV.
5. Connect Audio Cables between the AUDIO OUT jacks on the VCR and the AUDIO L and AUDIO R jacks on the TV.
 - If you have a mono (non-stereo) VCR, use a Y-connector (not supplied) to hook up to the right and left audio input jacks of the TV. If your VCR is stereo, you must connect two cables.

External Connection

Connecting DVD Player/Set-Top Box

The rear panel jacks on your TV make it easy to connect a DVD to your TV.

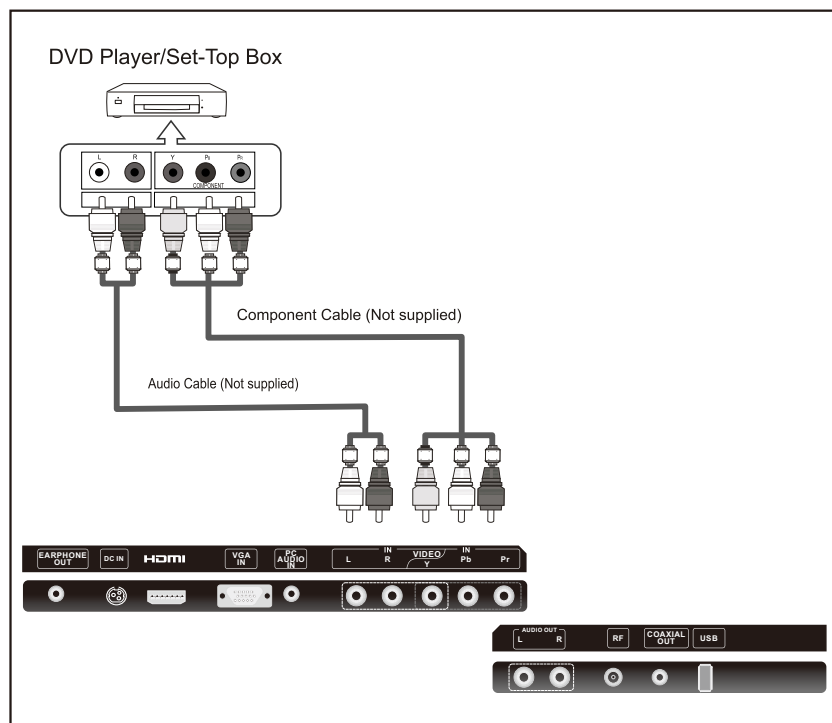

Component video separates the video into Y (Luminance (brightness)), Pb (Blue) and Pr (Red) for enhanced video quality.

Be sure to match the component video and audio connections.

For example, if connecting the video cable to COMPONENT IN, connect the audio cable to COMPONENT IN also.

Each DVD player/STB has a different back panel configuration.

When connecting a DVD player/STB, match the color of the connection terminal to the cable.

We recommend the use of cables with a Ferrite Core.

1. Connect a Component Cable between the COMPONENT IN [Y, PB, PR] jacks on the TV and the COMPONENT [Y, PB, PR] jacks on the DVD player.
2. Connect Audio Cables between the COMPONENT IN [R-AUDIO-L] jacks on the TV and the AUDIO OUT jacks on the DVD player.

External Connection

Connecting Digital Audio System

The rear panel jacks on your TV make it easy to connect a Digital Audio System to your TV.

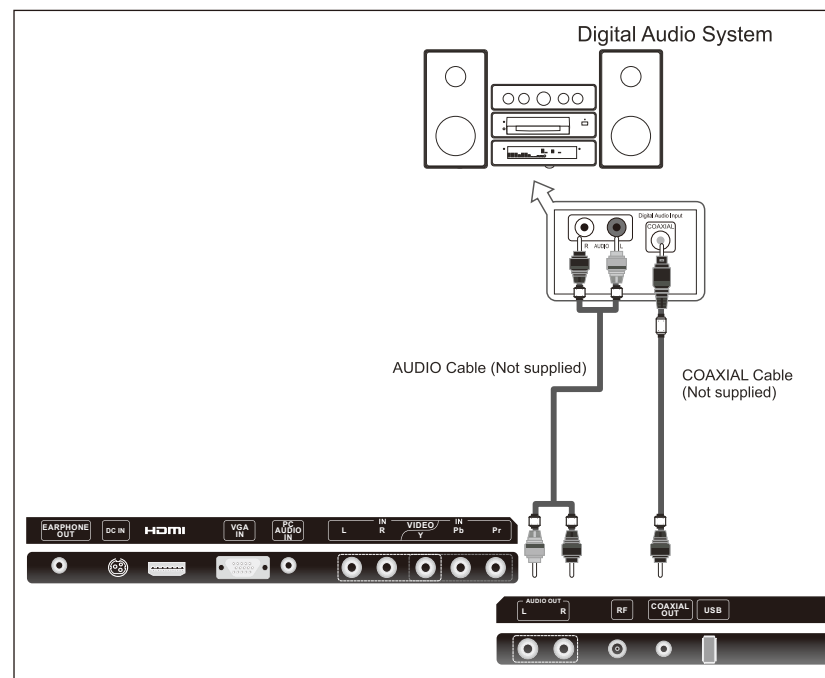

5.1 CH audio is possible when the TV is connected to an external device supporting 5.1 CH.

We recommend the use of cables with a Ferrite Core.

1. Connect COAXIAL Cable between the COAXIAL jacks on the TV and the Digital Audio amplifier.

Input jacks on the Digital Audio System. When a Digital Audio System is connected to the COAXIAL terminal: Decrease the gain (volume) of the TV, and adjust the volume level using the Digital Audio system's volume control.

2. R/L audio out

Audio out: output single from TV, AV, HDMI, PC.

Audio Out can be used to connect to an external Amp, Furrion Wallmount Stereo or Home Entertainment System.

This volume output is not controlled by the volume control on the TV or Remote Control.

To use this function, turn down the volume on the TV and use the volume control from AV Amp / Stereo / Tuner or Home Theater System.

External Connection

Connecting DVD Player/Set-Top Box via HDMI

This connection can only be made if there is a HDMI Output connector on the external device.

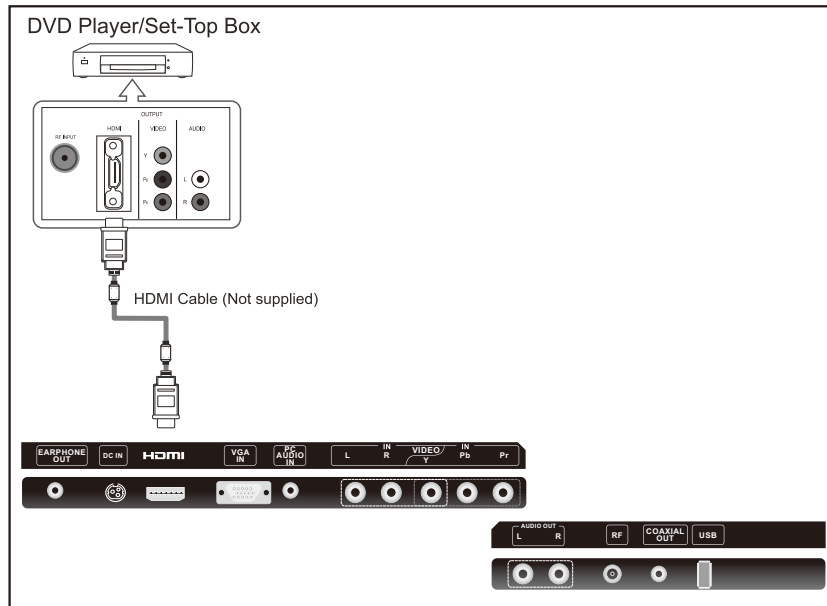

What is HDMI?

HDMI, or high-definition multimedia interface, is a next-generation interface that enables the transmission of digital audio and video signals using a single cable without compression.

Multimedia interface is a more accurate name for it especially because it allows multiple channels of digital audio (5.1 channels).

The difference between HDMI and DVI is that the HDMI device is smaller in size, has the HDCP(High Bandwidth Digital Copy Protection) coding feature installed, and supports multi-channel digital audio.

Each DVD player/STB has a different back panel configuration.

We recommend the use of cables with a Ferrite Core.

1. Connect an HDMI Cable between the HDMI connector on the TV and the HDMI connector on the DVD player/Set-Top Box.

External Connection

Connecting PC

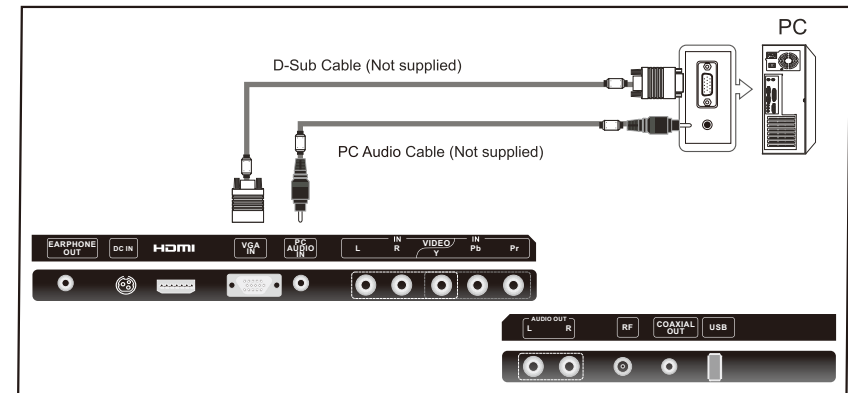

Each PC has a different back panel configuration.

The HDMI jacks do not support PC connection.

We recommend the use of cables with a Ferrite Core.

1. Connect a D-Sub Cable between RGB/PC IN connector on the TV and the PC output connector on your computer.
2. Plug PHONE out connector into PHONE out jack on the TV the TV speaker will be muted.
3. Connect the PC audio input jacks on the TV

Supporting signals

Input	Mode
Air	8VSB
Cable	Free64/256QAM
CVBS	NTSC3.58
S-Video	NTSC3.58

Input	Resolution	VerticalFrequency
Component	480p	60Hz
	720p	60Hz
	1080i	60Hz
HDMI	1080p	60Hz
	720p	60Hz
	1080i	60Hz
	1080p	60Hz

Input	Resolution	VerticalFrequency
PC/VGA	640x480	60Hz
	800X600	60Hz
	1024X768	60Hz
	1360X768	60Hz
	1920X1080	60Hz

Basic Operation

Turning the TV On and Off

1. How to turn the TV on or off

1. After attaching cable to either an antenna or a cable service, insert the power cord plug into a polarized AC outlet.
2. Press Φ button on the LED TV.
3. Normal picture will be displayed on the screen after 6 seconds. If no signal input, "No Signal" will be displayed on the screen.
4. If temporary POWER off is required, press Φ button on the LED TV.
5. If you want to completely switch off the power for this unit, unplug the power cord plug for this unit.
6. After switching off the unit, you should turn on the TV again at least 5 seconds later.

Status indication lamp

Green: In power on mode.

Red: In standby mode.

Auto power off

If there is no signal input in any Mode, the TV will automatically access the standby state in about 15 minutes.

Memory before turning TV off

The settings of picture and the preset channels will be memorized at turning off the unit. When being started up again, the unit will work according to the mode set before being turned off.

TV QUICK INSTALLATION GUIDE

1. Connect an Antenna or Cable to your TV set
2. Connect the power cord and turn TV on.
3. Go to initial Setup.

If using the TV for the first time, the initial setup menu will display.

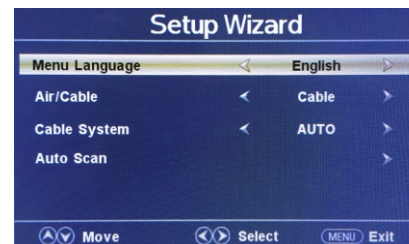

Menu Language

to choose your menu language, press the left/right arrows until the language you need appears.

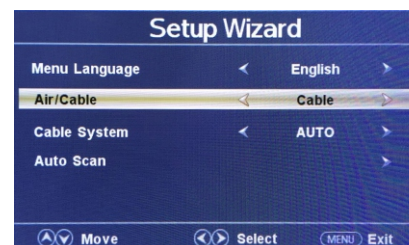

Air/Cable

Choose: Air or Cable
Press Up/Down button to choose, then highlight Auto Scan and press Enter to search all available channels.

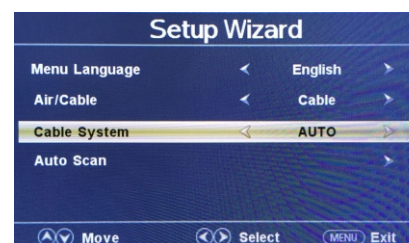

Cable System

This option is adjustable when Cable is selected in previous menu.
Variable range: AUTO/STD/IRC/HRC
Default: AUTO

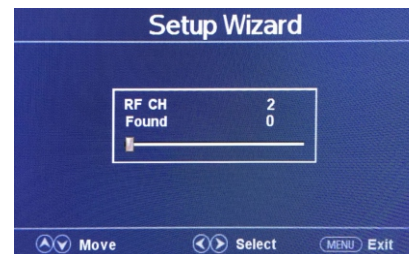

Auto Scan

Please wait for the automatic channel search to finish. This may take a few minutes.

PLEASE TAKE THE TIME TO READ THE ENTIRE INSTRUCTION MANUAL INCLUDED WITH YOUR TV FOR FURTHER OPERATING INFORMATION.
PLEASE KEEP THE ORIGINAL BOX FOR RETURNING YOUR UNIT IF SERVICE IS REQUIRED.

OSD Menu Operations

Adjust the OSD Screen



Press SOURCE button to display the input source list.
 Press ▼/▲ button to select the input source you want to watch.
 Press ENTER button to enter the input source.

Picture



OSD Menu Operations

Picture

Function introduction

Item	Variable range	Default	Explanation
Picture Mode	Standard/ Dynamic /Soft/ User	Standard	
Contrast	0----100	50	You will need to watch the picture when you adjust it, so, we close the main menu, pop up Contrast small menu
Bright	0----100	50	Same to Contrast
Color	0----100	50	This item is unavailable under VGA channel and DVI signal
Tint	-50----50	0	Only adjustable under NTSC signal, unadjustable under other signals. Recover to 0 under non NTSC signal.
Sharpness	0----100	50	This Item is unavailable under VGA channel and DVI signal
Color Temp.	Normal/Warm/Cool	Normal	
Blue Screen	On/Off	Off	After opening this option if there is no signal input, the screen turns blue.

OSD Menu Operations

Sound

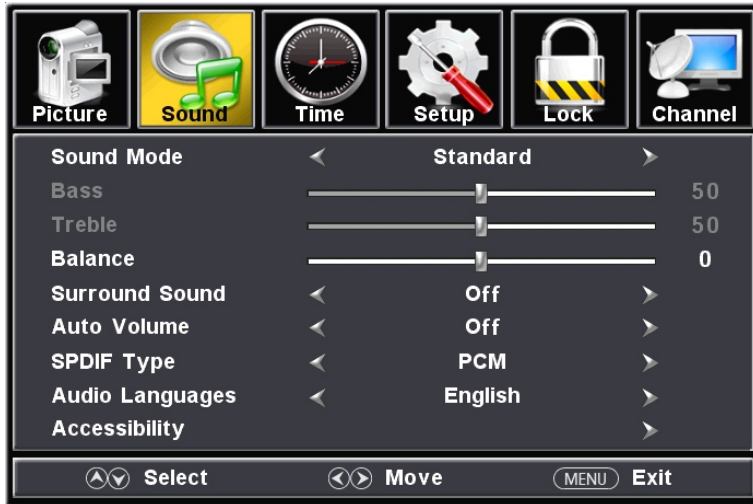

Function introduction

Item	Variable range	Default	Explanation
Sound Mode	Standard/ Music / Movie / User	Standard	
Bass	0---100	50	
Treble	0---100	50	
Balance	0---100	50	
Surround	Off/ On	Off	
Auto Volume	On/ Off	On	
SPDIF	RAW/ PCM	RAW	Only available under DTV channel and HDMI channel, it is grey under other channels
Accessibility	Voice Guide/ Video Description		Press left or right or enter key on the remote ,will enter the TTS subpage item settings.The meaning of the text read aloud, after opening can adjust the intensity and speed of sound

OSD Menu Operations

Time



Function introduction

Item	Variable range	Default	Explanation
Sleep Timer	Off/5Min/10Min/15Min/30Min /45Min/60Min/90Min/120Min /180Min/240Min	Off	
Time Zone	Pacific/Alaska/Hawaii /Eastern/Central/Mountain	Pacific	
Daylight Saving Time	Off/On	Off	Only adjustable under DTV channel.
Time Format	12-hour/24-hour	12-hour	
Auto Clock	Off/On	Off	

OSD Menu Operations

Setup



Function introduction

Item	Variable range	Default	Explanation
Menu Language	English/ French /Spanish	English	Now there are only three kinds of language for OSD, if clients need more, we can add
Transparency	Off/On	Off	
Zoom Mode	Non VG A channel: Wide/Zoom/Cinema /Normal VG A channel: Wide/Normal	Wide	Only can be adjusted when there is signal
Noise Reduction	Off/Weak/Middle/Strong	Middle	
advanced			It always stands for the preliminary menu include further sub page menu
Source Label			It always stands for the preliminary menu include further sub page menu
Closed Caption	Off/On	On	You can enter CCD submenu
DLC	Off/On	On	Dynamic contrast adjustment.
Setup Wizard			Press left or right will enter install setup menu.
Restore Default			Press left or right button then will enter restore page. User can select YES to default value for all the set up value. or select NO to does not restore.

OSD Menu Operations

Lock



Note:

Input the correct password with four number (from 0-9), then you can enter next level menu. If the password is wrong, then there will be prompting information in the middle of the menu



OSD Menu Operations

Lock

Function introduction

Item	Variable range	Default	Explanation
Set Password			Password to access user-defined menus.
System Lock	Off / On	Off	Child lock main switch, if it is off, US and Canada will be gray.
US			US V-chip set.
Canada			Canadian V-chip set.
RRT Setting			Canadian V-chip set. Only when the DTV code RRT traffic detected by the system, then you can enter the sub-menu, or it will be gray.
Clear Lock			Restore to the default v-chip settings.



Set password

User can modify the system password after press enter button, user can input 4 digital number in the line blank.

Confirm password

After modify the password, user must reconfirm the new password by it to make sure the password can work.

OSD Menu Operations

Lock



TV

Input defined by the user's television viewing menu.

MPAA

User can setting the child-level to watch TV Program.



Canada English

User can setting the child-level to watch TV Program by Canada English Character.

Canada French

User can setting the child-level to watch TV Program by Canada French Character.

OSD Menu Operations

Lock



Note:
Before the reset, it should alert the user and then confirm again.

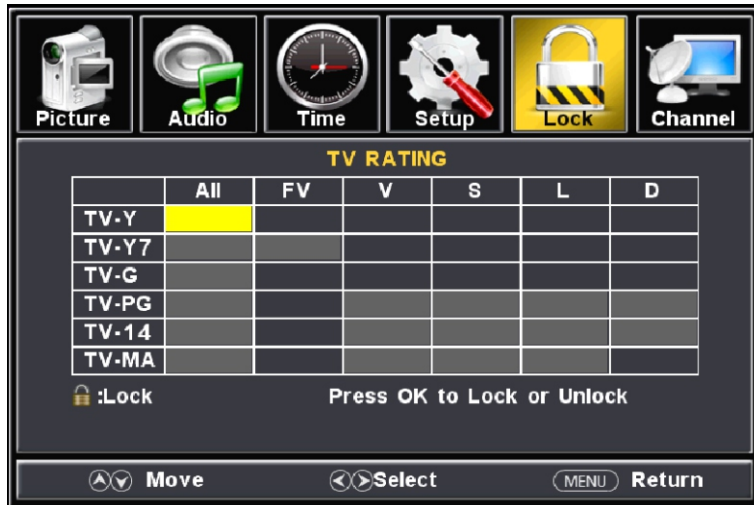

OSD Menu Operations

Lock

Note:

1. Use direction keys to move the object, press OK or Enter keys to lock or unlock. When lock it, it shows black screen and MUTE, pop out prompting menu for you to input password.
2. Only input correct password in prompt dialog box can you watch the program normally, but if you change the channel or close it and then return to this channel, you still need to input the password again.

Lock/ RRT Setting / Humor Level

Function explanation:

User can modify all of the RRT settings values by the item.

Lock/ RRT Setting / Intelligence Level

Function explanation:

User can restore the default settings values for the RRT settings values by the item.

Channel

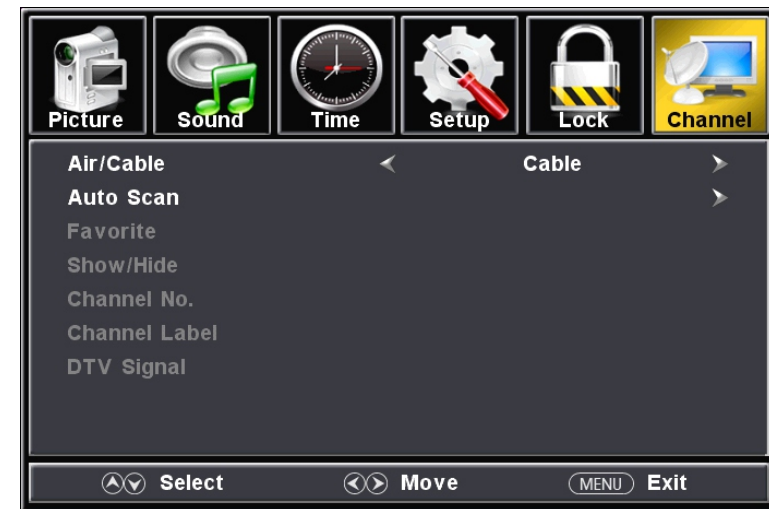

OSD Menu Operations

Channel

Function introduction

Item	Variable range	Default	Explanation
Air/Cable	Air/Cable	Cable	
Auto Scan			
Favorite			
Show/Hide			
Channel No.	Among all the channels searched		
Channel Label			
DTV Signal			



Cable System

User can select the standard mode for the wire search channel.

Start to Scan

Press right or enter button will Enter sub menu of searching.

FM Menu Operations

Adjust the FM Screen

FM

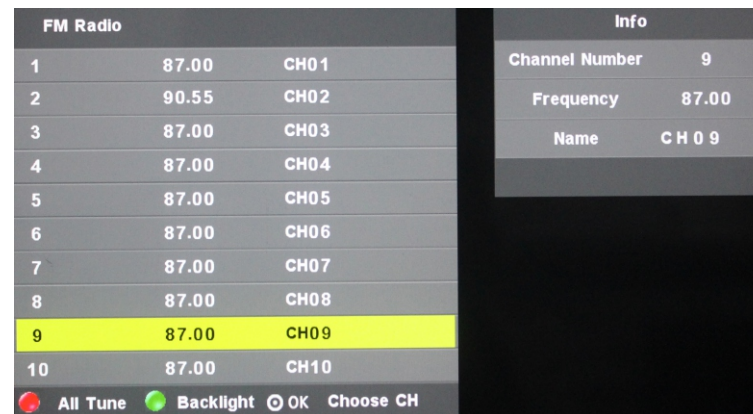

Remarks: TV cable must be plugged into the tv tuner jack before FM scanning&listening.

TV cable is used as an antenna when FM is selected.

Note: Press SOURCE button to set the input source to FM,

Press and hold CH+ button to turn on or off the backlight,

Press and hold menu button to Auto scan,

Press and hold CH- button to exit Auto scan,

Press CH+/- button to select channel.

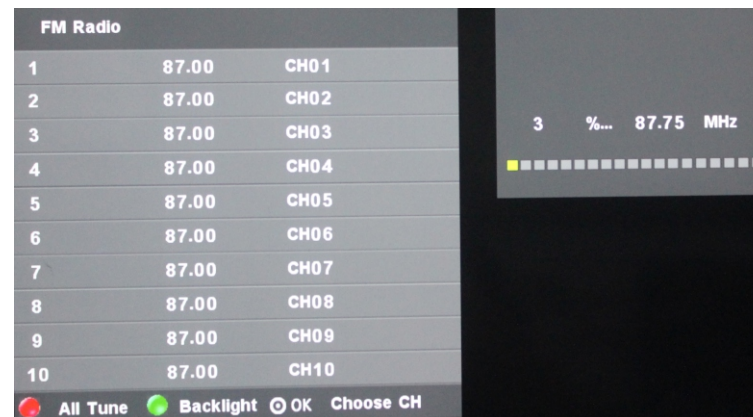

FM Menu Operations

Adjust the FM Screen

Press VOL+ button to Frequency, then press vol+ again to select Frequency value , press VOL +/- to fine-tune , press CH+ button to manual scan, Press and hold CH- to exit Frequency selection.

FM Radio			Info	
1	87.00	CH01	Channel Number	1
2	87.00	CH02	Frequency	87.00
3	87.00	CH03	Name	CH01
4	87.00	CH04		
5	87.00	CH05		
6	87.00	CH06		
7	87.00	CH07		
8	87.00	CH08		
9	87.00	CH09		
10	87.00	CH10		

All Tune Backlight OK Choose CH

FM Radio			Info	
1	87.00	CH01	Channel Number	1
2	87.00	CH02	Frequency	87.00
3	87.00	CH03	Name	CH01
4	87.00	CH04		
5	87.00	CH05		
6	87.00	CH06		
7	87.00	CH07		
8	87.00	CH08		
9	87.00	CH09		
10	87.00	CH10		

All Tune Backlight OK Choose CH

Press CH- button to Name ,press V+ button to select Name value, press CH+/- to change the name, Press and hold CH- to exit Name.

DVD

HOME

Press the "HOME" button menu, through the up and down direction keys can be select, Press the left or right button to select the DVD, and press the Enter button to enter. Press the DVD SETUP button to enter.

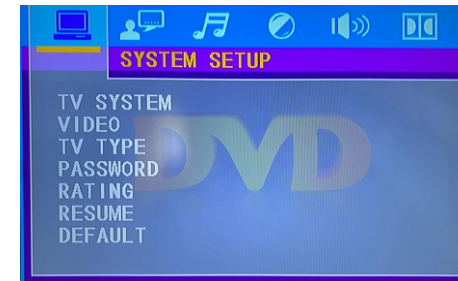

TV SYSTEM

Set the options are: NTSC/PAL/AUTO.

VIDEO

Video Options.

TV TYPE

Set the screen ratio options are: PS(4:3 Pan Scan), Normal/PS(4:3 Letter Box), and Wide (16:9)the default settings is wide.

PASSWORD

Enter "0000" to enter.

RATING

Level Disc Options.

RESUME

Restore to factory settings.

DEFAULT

This option will return the DVD to it's factory default settings.

**OSD LANGUAGE**

Set the OSD Language options.

AUDIO LANG

DVD language selection options.

SUBTITLE LANG

This player can display DVD subtitle languages if supported by the DVD disc. when playing DVD's you can hide the subtitle or choose any of them as the current subtitle language.

MENU LANG

Set the MENU Language options.

**AUDIO OUT**

Press the "ENTER" Key enter, through the up and down direction keys can be select.

KEY

Press the "ENTER" Key enter, through the up and down direction keys can be select.

**BRIGHTNESS**

DVD Brightness options.

CONTRAST

DVD Contrast options.

HUE

DVD Hue options.

SATURATION

DVD Saturation options.

SHARPNESS

DVD Sharpness options.

**DOWNMIX**

DVD Downmix options.

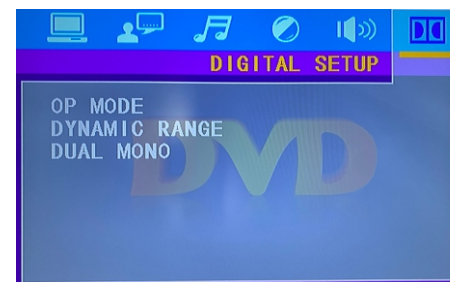
**OP MODE**

DVD Op mode options.

DYNAMIC RANGE

DVD Dynamic Range options.

DUAL MONO

DVD Dual Mono options.

Troubleshooting

If you have any problem, check the countermeasures for each symptom listed below. The following symptoms may have caused by inappropriate adjustment rather than actual malfunction of the unit. If the trouble persists, contact the service center.

Symptoms	Possible solutions
No power	Disconnect the power cord, wait 60 seconds then reconnect the power cord and restart the TV.
No picture	Check antenna connection. Station may experience problems, please tune to another station. Please adjust the settings of contrast and brightness.
Good picture but no sound	Increase the volume. please check sound settings.
Good sound but abnormal color or no picture	Check the antenna connection.
No remote control	No support for this function.
Full screen flickering under VGA	V-HEIGHT value may be set too big, restart computer and enter safe mode, then set monitor parameters to correct value according to adjustment description.
Horizontal stripes under VGA	Sample phase may be deflected, adjust phase according to picture position.
Colored dots may be present on the screen	This product is the high resolution LED display device and a few cell defects can occur in the manufacture of the LED. Several colored dots visible on the screen would be acceptable. in line with other LED manufacturers and would not mean that the LED is faulty. We hope you will understand that it could not be changed or refunded.

Picture defects and the reason



Snowy Picture

Snowy picture is usually due to weak signal. Adjust antenna or install an antenna amplifier.



Double Image or Ghosts

Double images are usually caused by reflections from tall buildings. Adjust the direction of the antenna or raise it.



Radio Wave Interference

Wave patterns are moving on the screen, which are usually caused by nearby radio transmitters or short-wave receiving equipment.



High Temperature Electrothermal Interference

Diagonal or herringbone patterns appear on the screen or part of picture is missing. This is probably caused by high temperature electrothermal equipment in a nearby hospital.

Warranty

Thank you for purchasing this Sylvox product. We are glad to offer 12 months free warranty for you. If you have any questions, please contact us via our after-sales email or website for assistance.

After-sales email: service@sylvoxtv.com

Website: www.sylvoxtv.com