

# SOLOSHOT<sup>®</sup> 3

First-Time Tracking



## GETTING READY

### In the Box

---

#### 1. SOLOSHOT3

Camera Lens, Camera Base, Tag and Armband

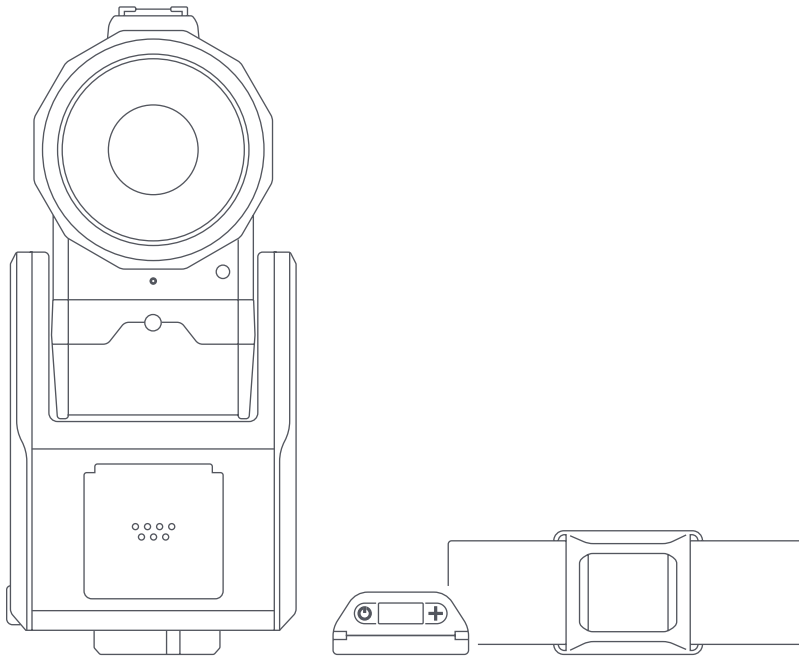

#### 1. Sturdy Tripod

sold separately

1/4" or 3/8" mounting screw

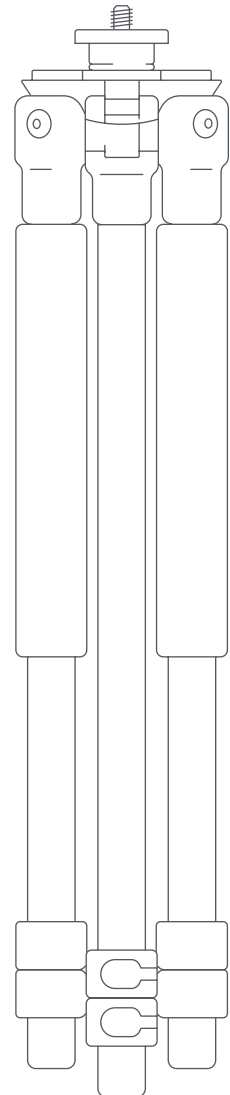

#### 3. Approved Micro SD Card

sold separately

See [www.soloshot.com/sdcards](http://www.soloshot.com/sdcards)



## GETTING READY

### Where to Set-Up

#### TRACKING IS FOR OUTDOOR USE ONLY

The SOLOSHOT3 Camera and Tag have several setup requirements:

##### OPEN AREA



Choose a park, field or beach, so that both Camera and Tag have a good view of sky.

**IMPORTANT:** Your Camera has a built in GPS and compass. Setting up near buildings, cliffs, trees, large metal objects, and power lines can affect tracking accuracy.

##### CLEAR VANTAGE POINT

Ensure that the Camera has an unobstructed view of the subject who will be wearing the Tag.

**For Example,** ensure that people won't be consistently standing or passing directly in front of the Camera.



##### FLAT AREA

**For this tutorial,** setup and perform your activity on a flat area. SOLOSHOT3 and the subject being tracked should be roughly on the same level.

##### LEVEL SET-UP

For best results, make sure the horizon is level in your Camera. Use your tripod's bubble level to confirm a level setup.

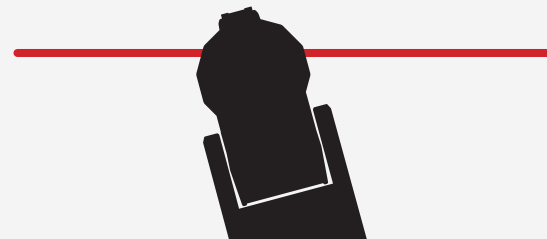

## STEP 1

### Power on Camera and Tag early

**Tracking requires a strong GPS signal to work. The stronger the signal, the better the tracking will be.**

Power on the Camera and Tag when first arriving to your location in order to give SOLOSHOT3 a few minutes to acquire the best GPS signal possible.

#### IMPORTANT

After powering Tag on, place on a flat surface with logo facing the sky. Do not keep in your hand or put in a pocket or bag.

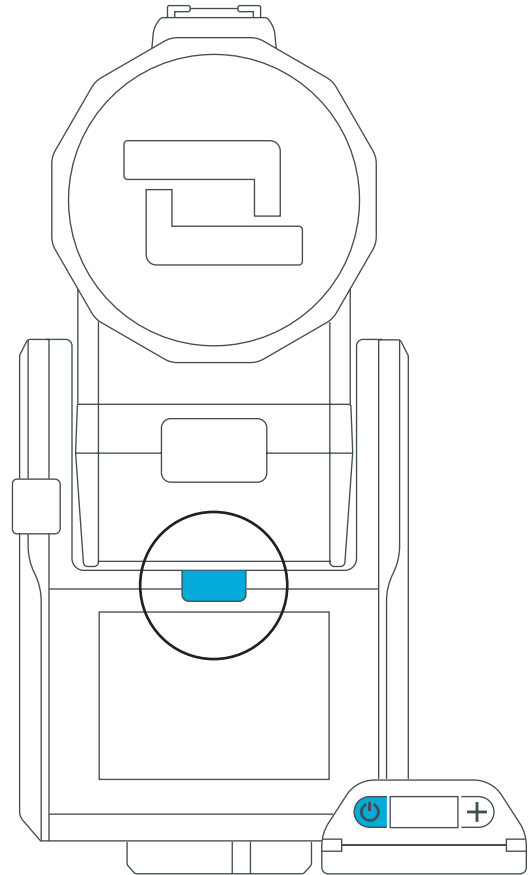

## STEP 2

### Prepare the Tag

**Make sure that your Tag is on and has a good GPS signal.**

Finding a GPS signal can take up to 3 minutes.

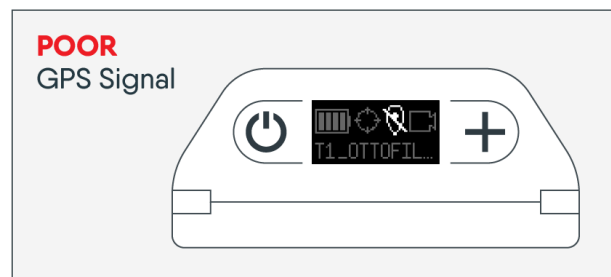
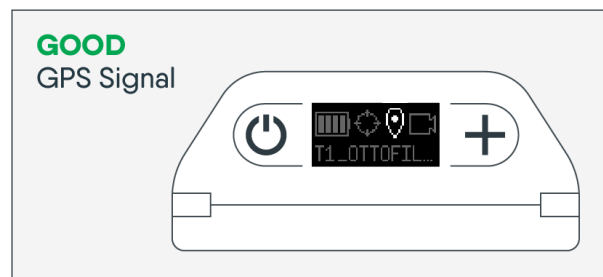

- A.** From the Home Screen on the back of the Camera, **Tap the Track icon** to launch the Track App.

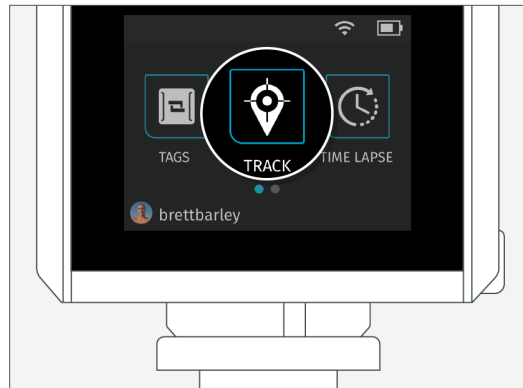

- B.** Tap the Tag icon (  ) to view available Tags.

Left number:  
Tags being tracked

Right number:  
Paired tags in range



- C.** The name of the Tag will match what's displayed on the Base.

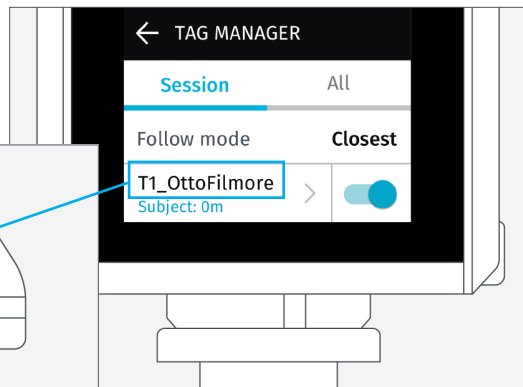
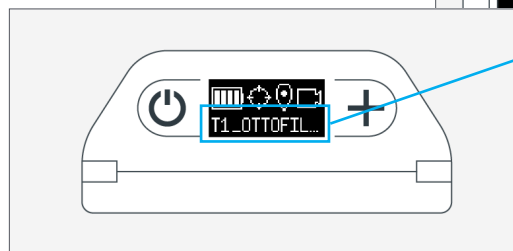

- D.** Ensure that Tracking is toggled ON (  ) by tapping slider.

If OFF (  ), tap the slider to toggle on.

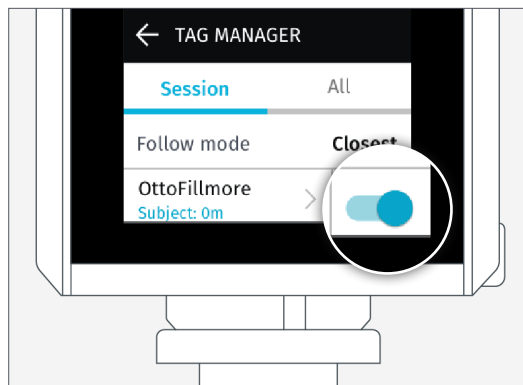

- E. Tap the back arrow** ( ← ) in the top left to return to the main screen of the Track App.



## TROUBLESHOOTING

### If the Tag is not shown in the Tag Manager

- A. Dock the Tag** to the front of the Camera Base.

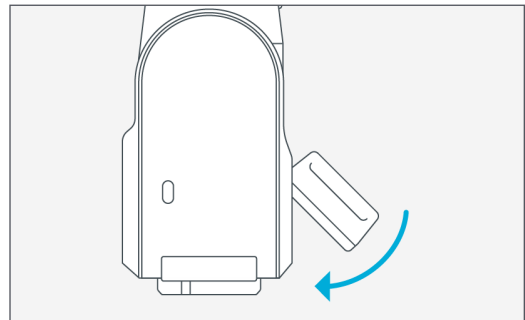

- B. You will see your Tag** appear in the list.  
**Ensure Tracking is toggled ON** (  ).

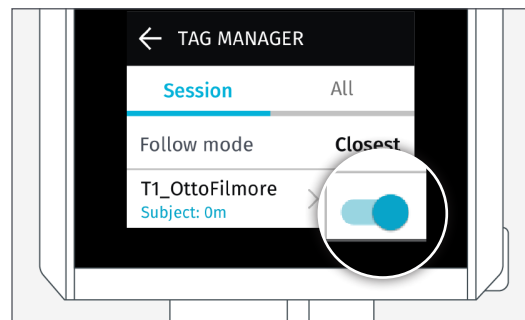

- C. Undock your Tag.**

**Tap the back arrow** ( ← ) in the top left to return to the main screen of the Track App.

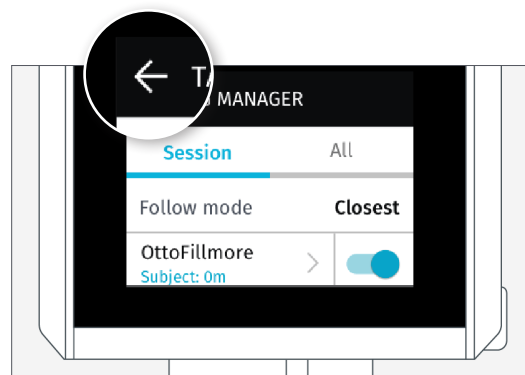

## STEP 3

### Prepare the Camera

A. Tap the blue Tracking button (  ).

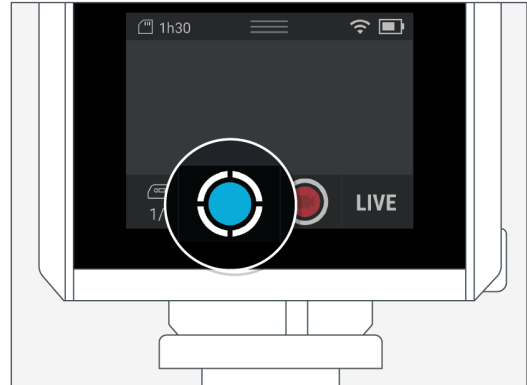

B. Select TRACK.

The default settings will be used:

MODE: Video

RESOLUTION: 1080p60

FRAMING: Bottom Middle

FOV: Medium

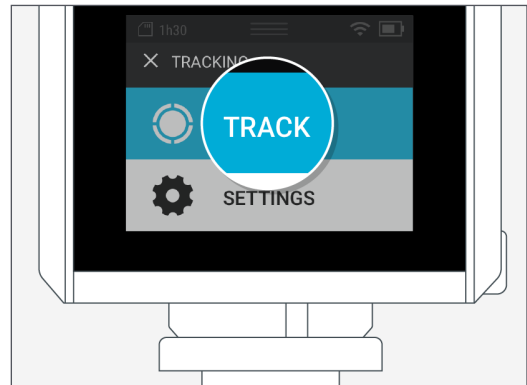

C. Select Field Mode.

Tap CONTINUE.

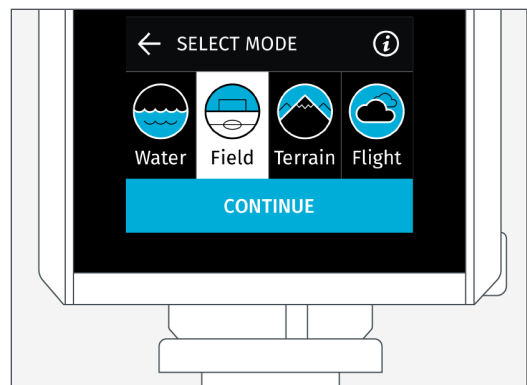

**IMPORTANT!**

## Tag must always be 30 ft. away from the Camera

---

The Camera will not track well when the Tag is less than 30 feet from the Camera.

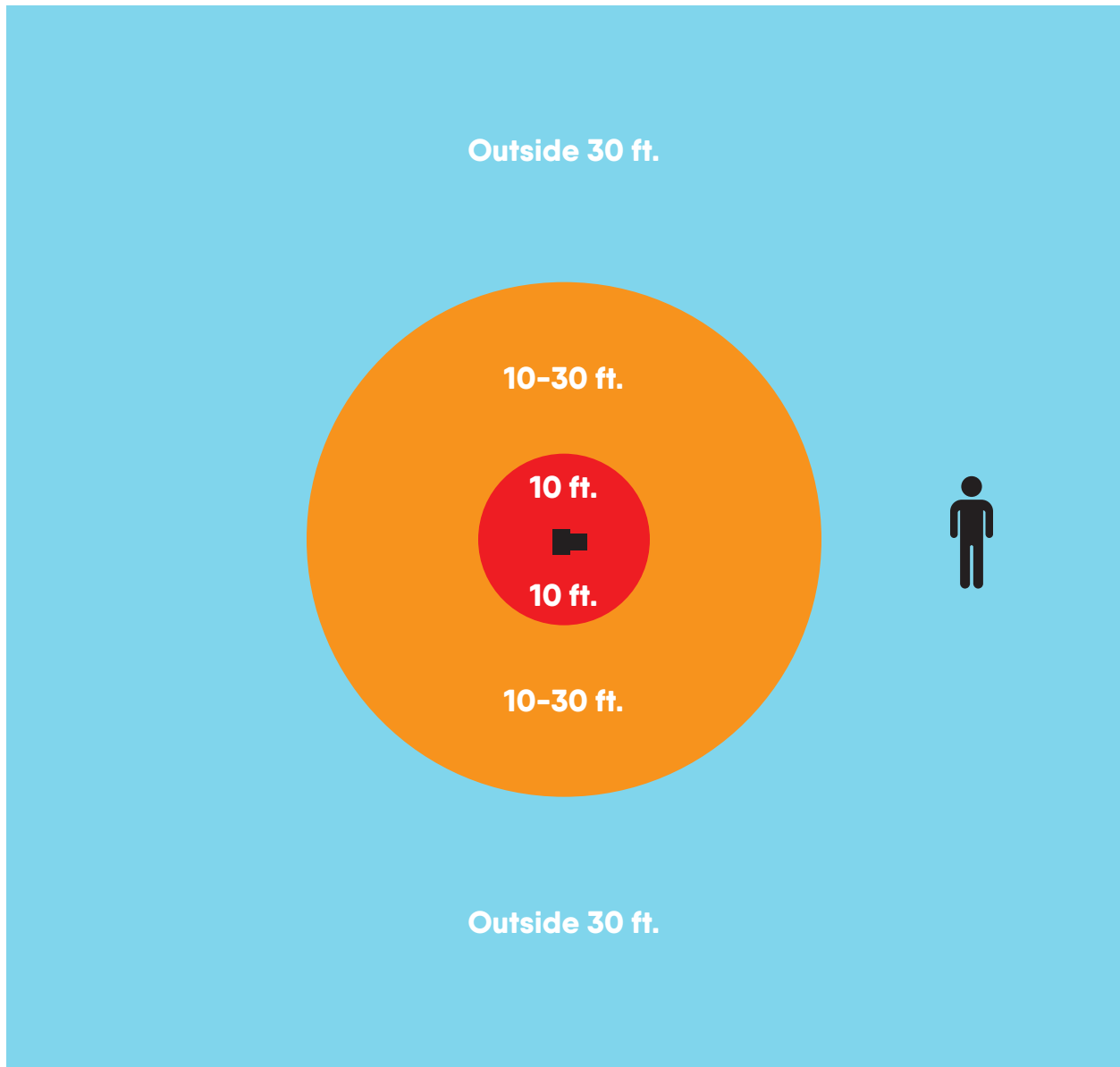



**NOTE:** For purposes of this tutorial, we're using Field Mode. In the future, feel free to try the other Track Modes based on what activity you'll be filming.

**Water**

- Surf
- Kiteboarding
- Wakeboarding

**Field**

- Soccer
- Equestrian
- Flat Track Racing

**Terrain**

- Mountain Sports
- Motocross
- Large Race Tracks

**Flight**

- RC Airplanes
- Paragliding

**D. Select START** to begin calibration.

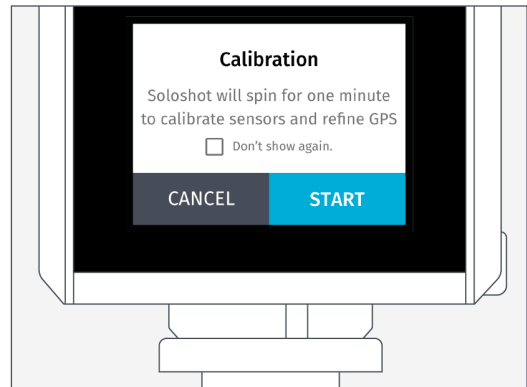

**E. Make sure Tag is at least 30 feet (15 paces from Base** during calibration as illustrated on page 8.

**NOTE:** The Camera will spin for about one minute as it calibrates its sensors. It will let you know if it thinks the GPS signal in the area is not sufficient for tracking.

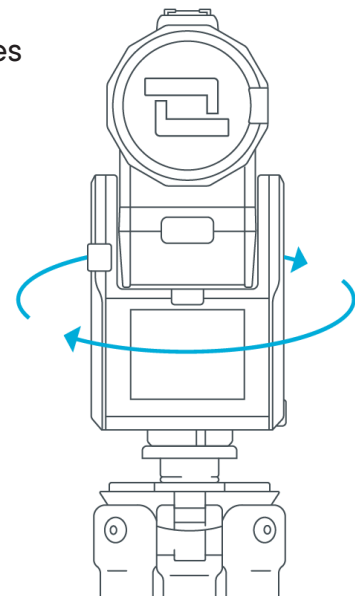

## STEP 4

### Successful Calibration

The Camera will point at the Tag after calibration and automatically begin recording.

*Refer to Step 8 for instructions on recording.*

If the Camera is not pointing at the Tag after calibration, begin walking back and forth at least 30 feet away (15 paces) from the Camera until the green light can be seen.

#### What does good Tracking look like?

There is a green LED that points in the same direction as the Camera. As you move around with the Tag, you should continue to see the green light clearly as the Camera tracks the Tag.

If you do not see the green light see steps 5 & 6 below.

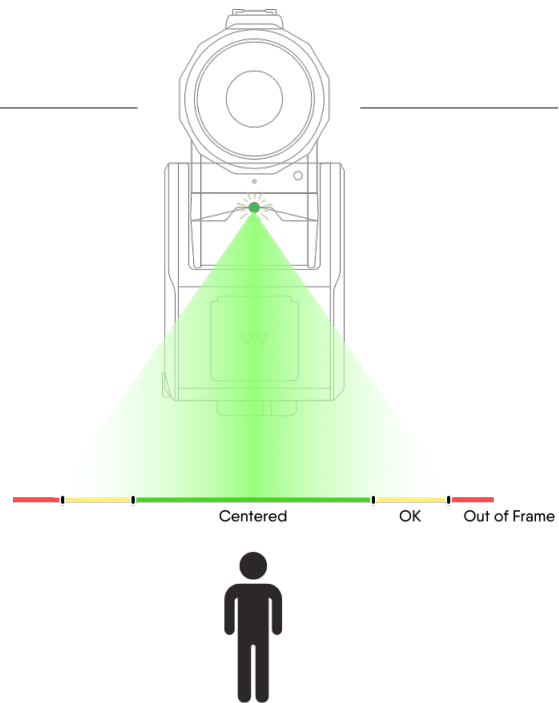

## STEP 5

### How To Improve Tracking: Automatically

SOLOSHOT3 constantly works to center framing and tighten zoom during use.

Typically, initial tracking inaccuracies and limited zoom will be resolved after a few minutes of tracking.

#### TO IMPROVE TRACKING ACCURACY

Walk side to side 5-6 times at least 50 feet from the Camera.

#### ZOOMING

Your SOLOSHOT3 will limit zoom until it hones in on the Tag. Once this is achieved, it will maintain your desired field of view.

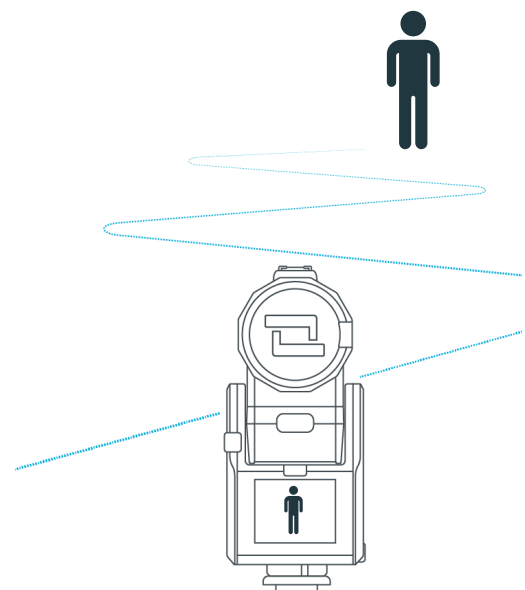

## STEP 6

### How To Improve Tracking: Manually

A. Place the Tag down (logo up) at least 30-ft. from the Camera.

B. Access the dropdown menu from the top of the screen on the back of the Camera.



C. Tap the Arrows button.



D. Use the arrows to manually center the Tag in the screen.

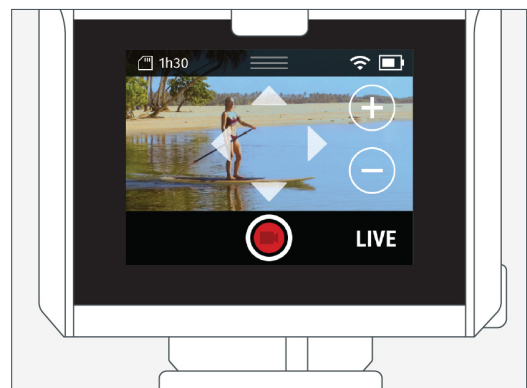

E. Tap the empty area on the left-side of the screen to **exit and continue Tracking**.

## STEP 7

### Wear the Tag

---

- A. Snap the Tag into the Clip** with the button side aligned to the clip window.

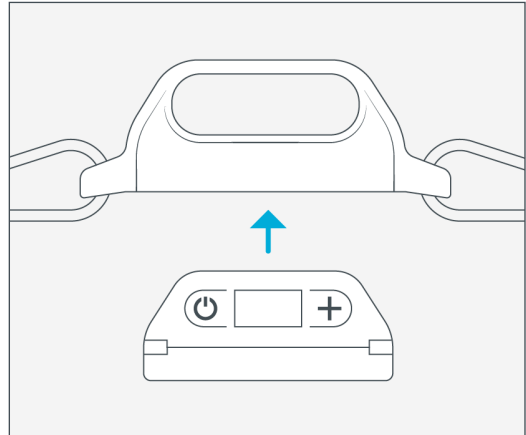

- B. Wear the Tag** with **buttons facing upward** and **logo facing out**.

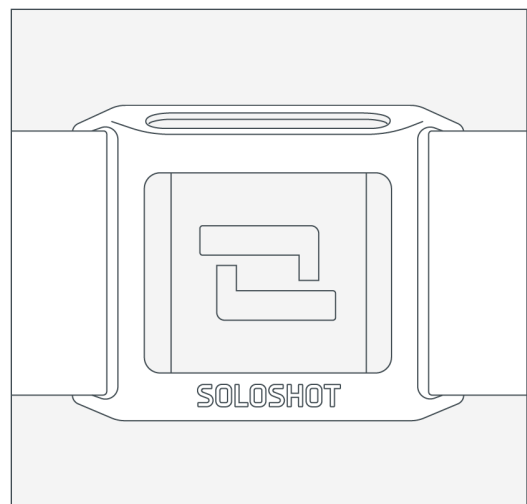

### IMPORTANT

Holding the Tag upside-down, holding it in a closed hand or putting it in a pocket may cause poor tracking.

## STEP 8

# Start/Stop Recording

**Record starts automatically after calibration by default.**

You can start and stop recording from either the Tag or the Base.

### From the Tag

Press and hold the ( + ) plus button to toggle record on or off

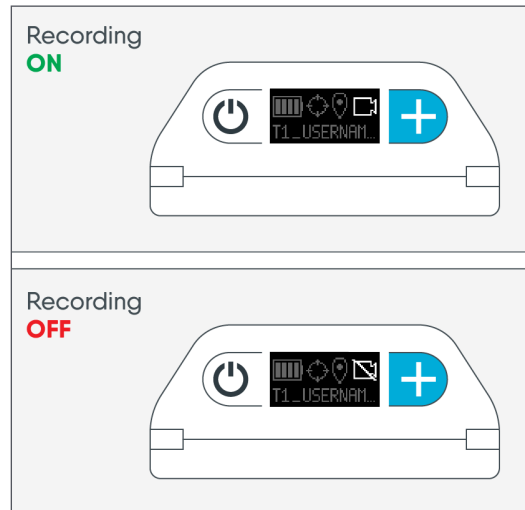

### From the Base

Tap the ( ● ) record button to start or stop recording.



## STEP 9

# Ending your Session

To end the session, **close out of the Track App**.

**A.** Access the **dropdown menu**.



**B.** Tap the **Home button**.



**C.** You'll now be in the main menu.



## STEP 10

### Power Off

---

You can power off the device at any time, even if you're actively recording and/or tracking.

#### Powering down the Camera

Hold down the power button for 3-seconds, then tap Power Off to confirm your selection.

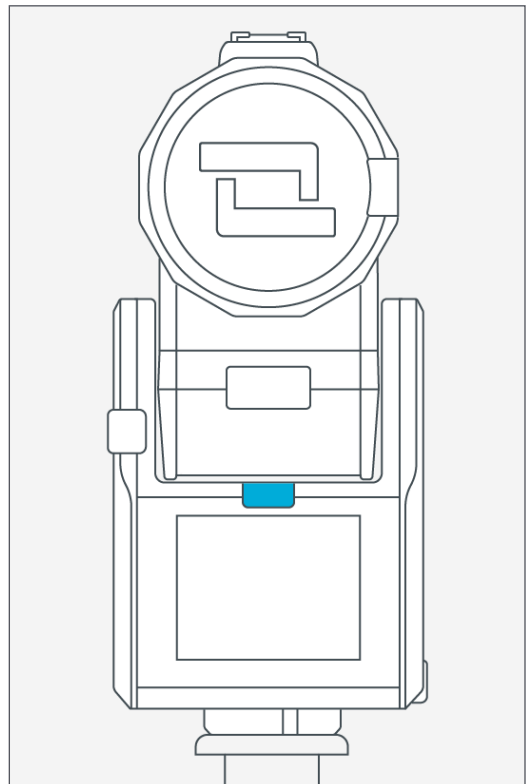

#### Powering down the Tag

Press the power button for 2 seconds.

