

REGISTRATION AND UPDATE

1. Create an Account

Create a SOLOSHOT account at:
app.soloshot.com.

IMPORTANT

A SOLOSHOT account is required before setting up your SOLOSHOT3.

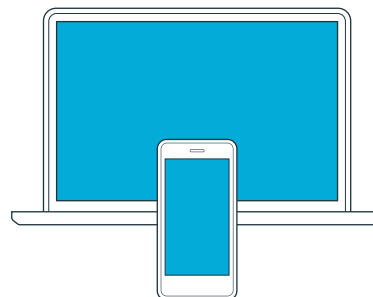

IMPORTANT

Complete the following checklist before beginning the registration and update process:

- ✓ Ensure that the Camera is assembled
- ✓ Dock the Tag into the charging port on the front of the Camera
- ✓ Connect the Camera to power
- ✓ Place the Camera in an upright position

2. Power On Tag and Camera

Camera Base:

Press and hold the power button [] for 3-seconds. The screen on the back of the Camera will start up. This is a 30-second to 1 minute process.

Tag:

Press the power button [] on the Tag.

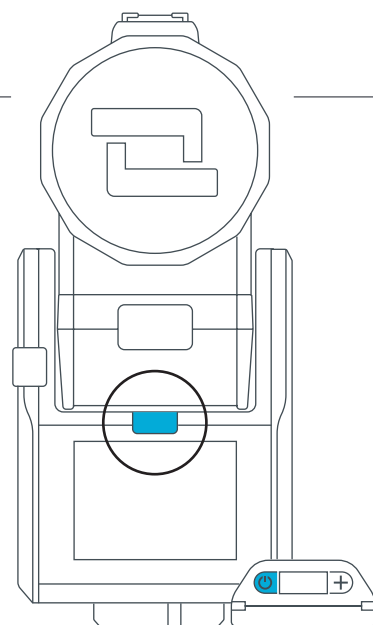

3. Start the Update

With the Camera and Tag powered on, **select CONTINUE.**

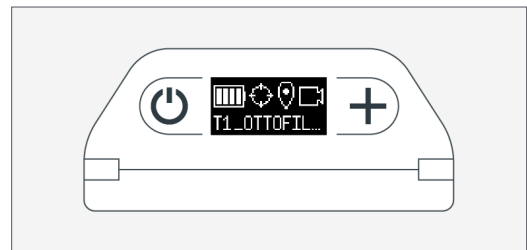
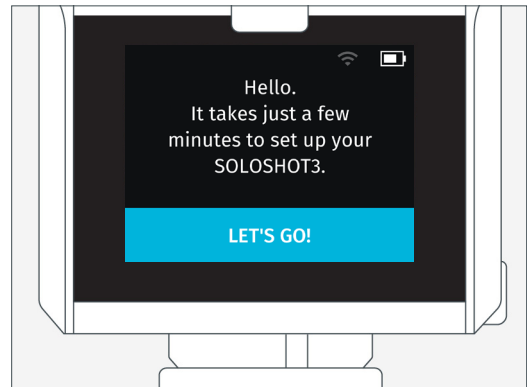

4. Connect to Wi-Fi

Select CONTINUE to scan for available Wi-Fi networks.

Select and connect to your preferred network.



5. Check for Available Update

Once connected to WiFi, the Camera Base will **automatically check for an update.**

With your SOLOSHOT being brand new, there will always be an available update.

Select DOWNLOAD.

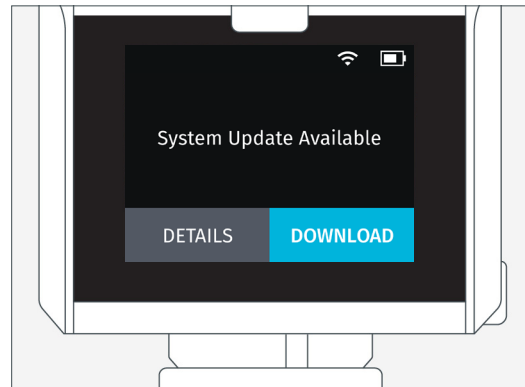

6. Download & Install Update

The Camera Base will download the update.

Once the update has been downloaded, **select OK** to restart the Camera Base.

This will take about 4 minutes.

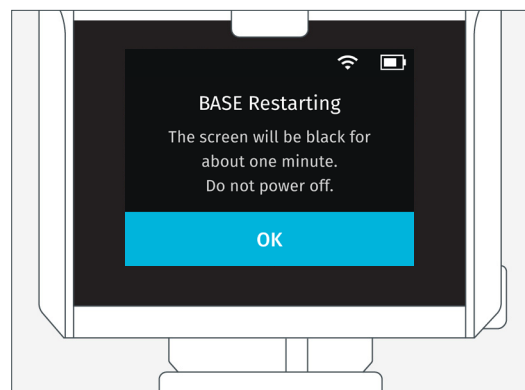

7. Registration

Register your Camera Base with your SOLOSHOT account.

You should already have account, as outlined in Step 1 above.

Select REGISTER.

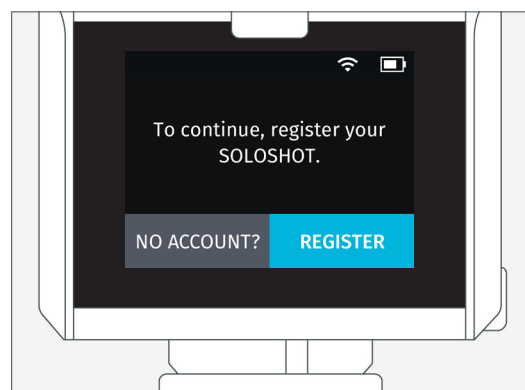

8. Enter Account Info

Enter your email or username password.

Select **REGISTER**.

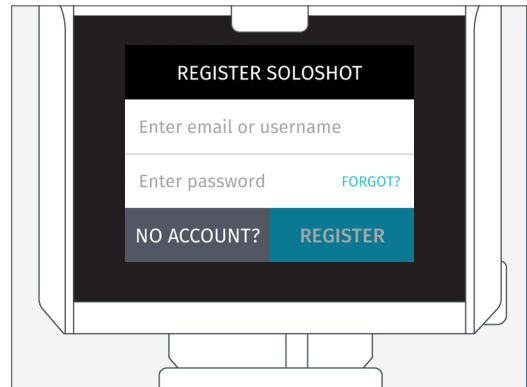

9. Successful Registration

Select **CONTINUE**.

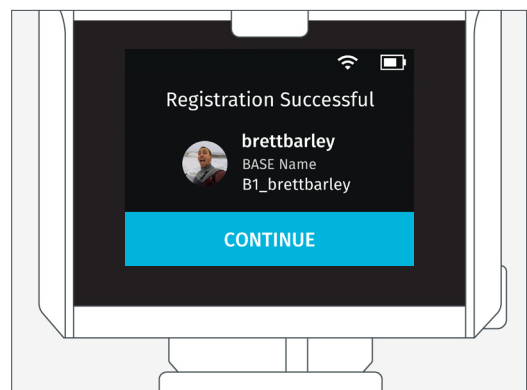

10. Update Camera

After the Camera Base has restarted, it will automatically update.

Once the update is successful, **select CONTINUE**.

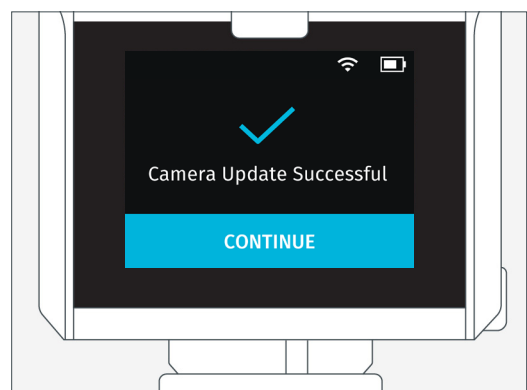

11. Update Tag

Ensure that your Tag is powered on and docked to the Camera Base.

Select NEXT to update the Tag.

Once updated, reboot the Tag and **select CONTINUE**.

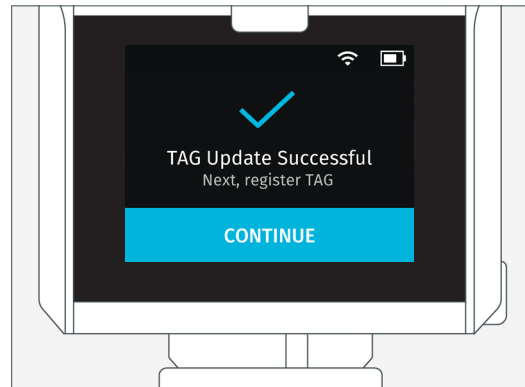

12. Register Tag

Select REGISTER.

Once registration is successful, **select CONTINUE**.

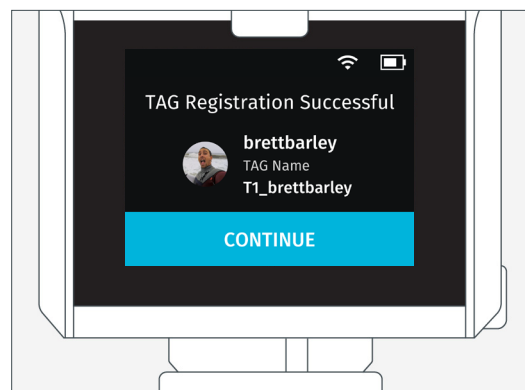

13. Tag Preferences

Choose your Tag Preference:

Auto Track: When the Tag is turned on and within range of the Camera Base, tracking automatically be toggled on. (Default)

Ask to Track: When the Tag is turned on and within range of the Camera Base, tracking will need to manually be toggled on.

If you have another Tag to Update and/or register, **select YES** and repeat the process as outlined here in Step 11.

If you are finished, select **NO, FINISH**.

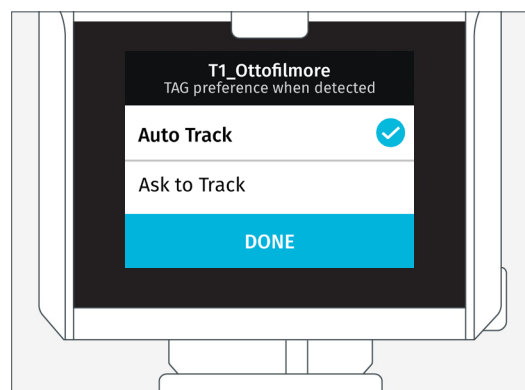

14. Time Zone

Select your time zone.

Tap the back arrow (←) to continue.

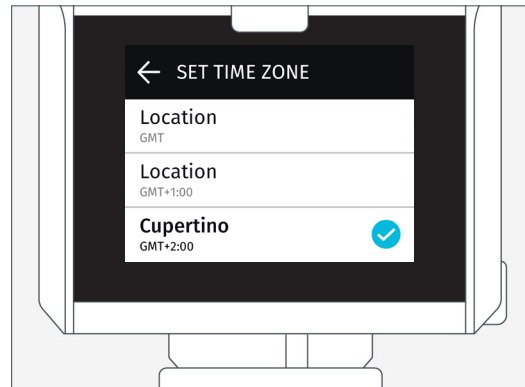

15. Update Summary

A summary of the software version installed on your SOLOSHOT3 will be displayed confirming that the update has been successful.

Select OK.

