



EDITOR & CREATOR
of MID-CENTURY *ICONS*

COF
FEE
TAB
LES



Coffee tables

FOX ROUND COFFEE TABLE S & M

Story behind:

Designed by 366 Concept as a contemporary addition to the Fox Series. A hand-finished table of premium quality solid wood. Enjoy its timeless beauty and quality for years to come in your home. Light form will be a complete match for both minimalistic, modern and sublime interiors.

Design: 2017 by Agata Górka

Legs: solid ash wood with brass finishing

Top: solid ash wood

Contract: norm passed EN 16139

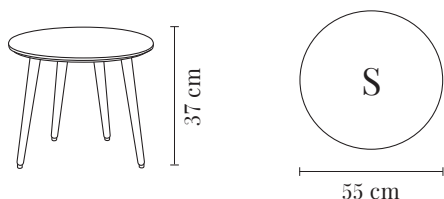

Width: 55 cm

Length: 55 cm

Height: 37 cm

Packaging dimensions: 42 x 59 x 59 cm

Net weight: 5,6 kg

Gross weight: 7 kg

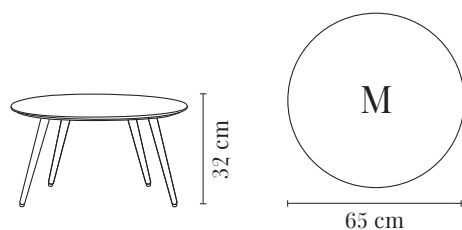

Width: 65 cm

Length: 65 cm

Height: 32 cm

Packaging dimensions: 36 x 69 x 69 cm

Delivery: fully assembled furniture

Net weight: 7,2 kg

Gross weight: 9 kg

100% designed and manufactured in Poland



Fox Round Coffee Table S / Ash 03



Fox Round Coffee Table M / Ash 03



Coffee tables

FOX ROUND COFFEE TABLE L28

Story behind:

Designed by 366 Concept as a contemporary addition to the Fox Series. A hand-finished table of premium quality solid wood. Enjoy its timeless beauty and quality for years to come in your home. Light form will be a complete match for both minimalistic, modern and sublime interiors.

Design: 2017 by Agata Górka

Legs: solid ash wood with brass finishing

Top: solid ash wood

Contract: norm passed EN 16139

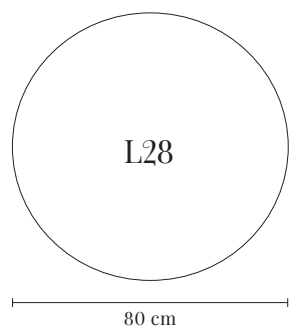
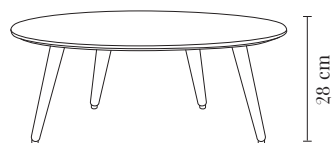

Width: 80 cm

Length: 80 cm

Height: 28 cm

Packaging dimensions: 32 x 84 x 84 cm

Delivery: fully assembled furniture

Net weight: 9,6 kg

Gross weight: 12 kg

100% designed and manufactured in Poland



Ash 03



Ash 03



Coffee tables

FOX ROUND COFFEE TABLE L32

Story behind:

Designed by 366 Concept as a contemporary addition to the Fox Series. A hand-finished table of premium quality solid wood. Enjoy its timeless beauty and quality for years to come in your home. Light form will be a complete match for both minimalistic, modern and sublime interiors.

Design: 2017 by Agata Górka

Legs: solid ash wood with brass finishing

Top: solid ash wood

Contract: norm passed EN 16139

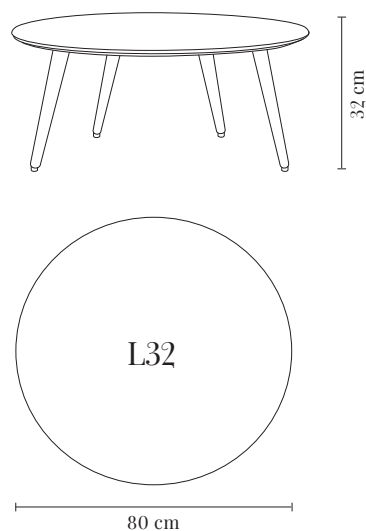

Width: 80 cm

Length: 80 cm

Height: 32 cm

Packaging dimensions: 40 x 84 x 84 cm

Delivery: fully assembled furniture

Net weight: 9,6 kg

Gross weight: 12 kg

100% designed and manufactured in Poland



Ash 03



Ash 03



Coffee tables

FOX ROUND SIDE COFFEE TABLE H

Story behind:

Designed by 366 Concept as a contemporary addition to the Fox Series. A hand-finished table of premium quality solid wood. Enjoy its timeless beauty and quality for years to come in your home. Light form will be a complete match for both minimalistic, modern and sublime interiors.

Design: 2017 by Agata Górka

Legs: solid ash wood with brass finishing

Top: solid ash wood

Contract: norm passed EN 16139

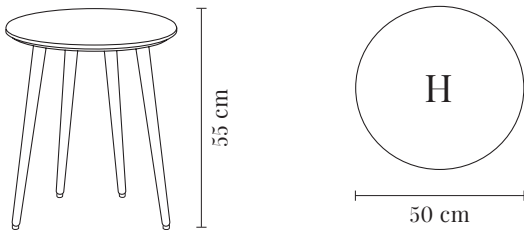

Width: 50 cm

Length: 50 cm

Height: 55 cm

Packaging dimensions: 59 x 54 x 54 cm

Delivery: fully assembled furniture

Net weight: 7,2 kg

Gross weight: 9 kg

100% designed and manufactured in Poland



Ash 03



Ash 03



Coffee tables

FOX SQUARE COFFEE TABLE S37

Story behind:

Solid ash wood and brass finish - an exclusive collection of coffee tables to match the Fox Lounge Chairs. The highest quality materials and the finest finish will delight any design connoisseur who is looking for a timeless addition to his interior. Available in 4 colors of ash wood and in 2 different heights: S37 and S55.

Design: 2017 by Agata Górka

Legs: solid ash wood with brass finishing

Top: solid ash wood

Contract: norm passed EN 16139

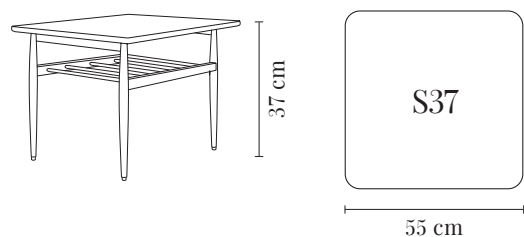

Width: 55 cm

Length: 55 cm

Height: 37 cm

Packaging dimensions: 59 x 59 x 59 cm

Delivery: fully assembled furniture

Net weight: 5,6 kg

Gross weight: 7 kg

100% designed and manufactured in Poland



Ash 03



Ash 03



Coffee tables

FOX SQUARE COFFEE TABLE S55

Story behind:

Solid ash wood and brass finish - an exclusive collection of coffee tables to match the Fox Lounge Chairs. The highest quality materials and the finest finish will delight any design connoisseur who is looking for a timeless addition to his interior. Available in 4 colors of ash wood and in 2 different heights: S37 and S55.

Design: 2017 by Agata Górka

Legs: solid ash wood with brass finishing

Top: solid ash wood

Contract: norm passed EN 16139

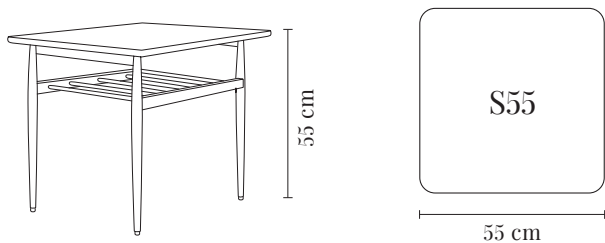

Width: 55 cm

Length: 55 cm

Height: 55 cm

Packaging dimensions: 59 x 59 x 59 cm

Delivery: fully assembled furniture

Net weight: 5,6 kg

Gross weight: 7 kg

100% designed and manufactured in Poland



Ash 03



Ash 03



Coffee tables

FOX RECTANGULAR COFFEE TABLE M37

Story behind:

The version lowered to a height of 37 cm fits ideally with the Fox Lounge Chair. Made of solid ash wood, finished with brass details. Available in 4 colors of ash wood and in 2 different heights: M37 and M55.

Design: 2017 by Agata Górká

Legs: solid ash wood with brass finishing

Top: solid ash wood

Contract: norm passed EN 16139

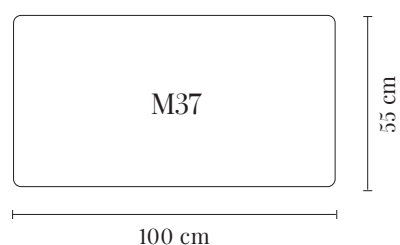
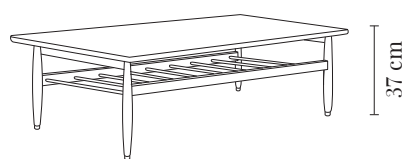

Width: 55 cm

Length: 100 cm

Height: 37 cm

Packaging dimensions: 40 x 104 x 59 cm

Delivery: fully assembled furniture

Net weight: 7,2 kg

Gross weight: 9 kg

100% designed and manufactured in Poland



Ash 03



Ash 03



Coffee tables

FOX RECTANGULAR COFFEE TABLE M55

Story behind:

This Rectangular Coffee Table is an ideal addition to the Fox Lounge Chair. Made of solid ash wood, finished with brass details. Available in 4 colors of ash wood and in 2 different heights: M37 and M55.

Design: 2017 by Agata Górká

Legs: solid ash wood with brass finishing

Top: solid ash wood

Contract: norm passed EN 16139

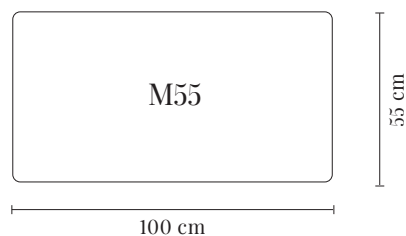

Width: 55 cm

Length: 100 cm

Height: 55 cm

Packaging dimensions: 59 x 104 x 59 cm

Delivery: fully assembled furniture

Net weight: 7,2 kg

Gross weight: 9 kg

100% designed and manufactured in Poland



Ash 03



Ash 03



Coffee tables

FOX TECKEL COFFEE TABLE

Story behind:

The brand-new Fox Teckel Coffee Table - the unique finish which harmonizes brilliantly with sofas and armchairs from the Fox Series. Wooden beams mounted under the countertop make this furniture not only exquisite, but also useful. These elements create an exceptional space for books, magazines and other personal pieces. Available in 4 colors of ash wood.

Original design: 1960s

Reedition: 2022 by 366 Concept

Legs: solid ash wood with brass finishing

Top: solid ash wood

Contract: norm passed EN 16139

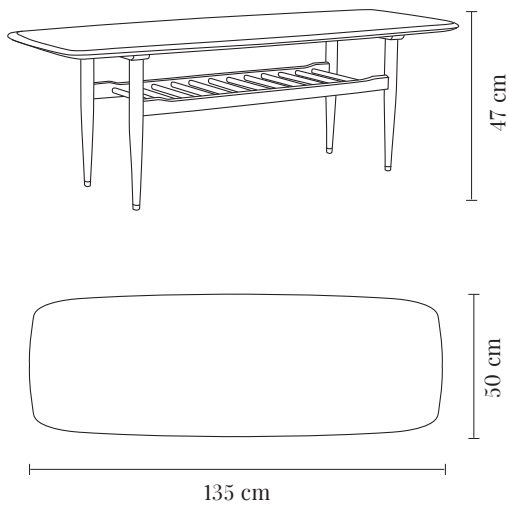

Width: 50 cm

Length: 135 cm

Height: 47 cm

Packaging dimensions: 140 x 60 x 60 cm

Delivery: fully assembled furniture

Net weight: 7,2 kg

Gross weight: 9 kg

100% designed and manufactured in Poland



Ash 03



Ash 03



Marshall

Coffee tables

FOX MARBLE ROUND COFFEE TABLE

Story behind:

A unique work created by 366 Concept. The combination of Italian marble with wooden legs made of solid ash creates charm and integrity. The marble top is finished with a unique cutter, which distinguishes this table and makes it even more special. All types of our marble tables are available in 7 colors of stone, as well as in 2 sizes 60 cm and 105 cm. Legs are also available in 4 different colors.

Design: 2022 by Maciek Cypryk

Legs: solid ash wood with brass finishing

Top: marble

Colors of marble top:

- **Brown** - Emperador Dark
- **Bordeaux** - Rosso Levanto
- **White & Grey** - Breccia Vagli
- **Creme** - Diana Royal
- **Taupe** - Pietra Beige
- **White** - Bianco Carrara
- **Black** - Nero Marquina

Contract: norm passed EN 16139

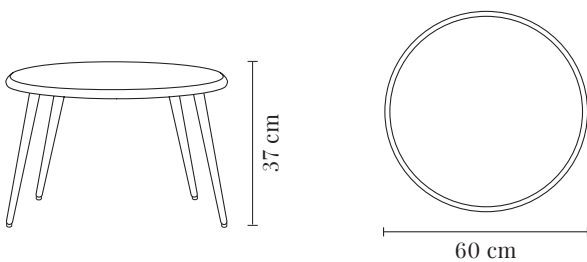

Width: 60 cm

Length: 60 cm

Height: 37 cm

Packaging dimensions: on pallet

Delivery: fully assembled furniture

Net weight: 15,2 kg

Gross weight: 19 kg

100% designed and manufactured in Poland



Marble Brown - Emperador Dark / Ash 03



Marble Brown - Emperador Dark / Ash 03



Coffee tables

FOX MARBLE LONG COFFEE TABLE

Story behind:

A unique work created by 366 Concept. The combination of Italian marble with wooden legs made of solid ash creates charm and integrity. The marble top is finished with a unique cutter, which distinguishes this table and makes it even more special. All types of our marble tables are available in 7 colors of stone, as well as in 2 sizes 60 cm and 105 cm. Legs are also available in 4 different colors.

Design: 2022 by Maciek Cypryk

Legs: solid ash wood with brass finishing

Top: marble

Colors of marble top:

- **Brown** - Emperador Dark
- **Bordeaux** - Rosso Levanto
- **White & Grey** - Breccia Vagli
- **Creme** - Diana Royal
- **Taupe** - Pietra Beige
- **White** - Bianco Carrara
- **Black** - Nero Marquina

Contract: norm passed EN 16139

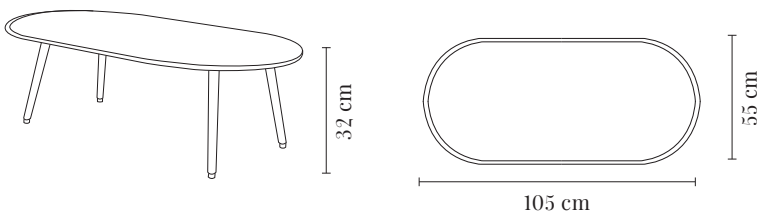

Width: 55 cm

Length: 105 cm

Height: 32 cm

Packaging dimensions: on pallet

Delivery: fully assembled furniture

Net weight: 21,6 kg

Gross weight: 27 kg

100% designed and manufactured in Poland



Marble Creme - Diana Royal



Marble White - Bianco Carrara / Ash 05



Coffee tables

366 TRIANGLE COFFEE TABLE S

Story behind:

You might think these tables were created in the 1960s, but in fact they were designed by 366 Concept. The characteristic triangular top channels the spirit of the Mid-Century era. The tables are made exclusively of solid wood and hand finished. Available in 4 colors of oak wood and in 2 different sizes: S and M.

Design: 2014 by Maciek Cypryk

Legs: solid oak wood with brass finishing

Top: solid oak wood

Contract: norm passed EN 16139

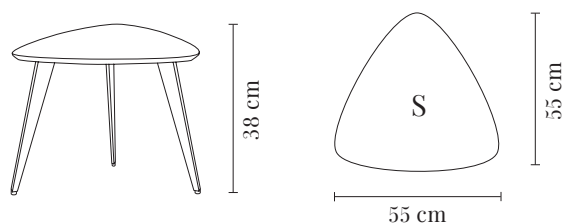

Width: 55 cm

Length: 55 cm

Height: 38 cm

Packaging dimensions: 42 x 59 x 59 cm

Delivery: fully assembled furniture

Net weight: 4,8 kg

Gross weight: 6 kg

100% designed and manufactured in Poland



366 Triangle Coffee Table S & M / Oak 03



Oak 03



Coffee tables

366 TRIANGLE COFFEE TABLE M

Story behind:

You might think these tables were created in the 1960s, but in fact they were designed by 366 Concept. The characteristic triangular top channels the spirit of the Mid-Century era. The tables are made exclusively of solid wood and hand finished. Available in 4 colors of oak wood and in 2 different sizes: S and M.

Design: 2014 by Maciek Cypryk

Legs: solid oak wood with brass finishing

Top: solid oak wood

Contract: norm passed EN 16139



366 Triangle Coffee Table M & S / Oak 03

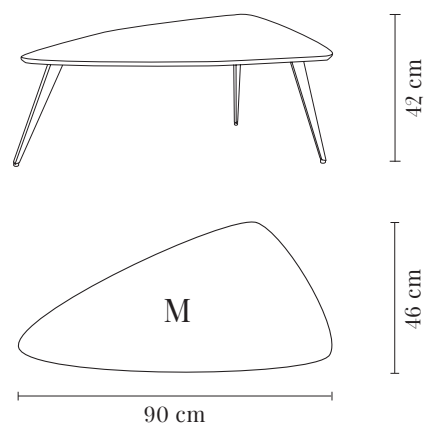

Width: 46 cm

Length: 90 cm

Height: 42 cm

Packaging dimensions: 46 x 94 x 50 cm

Delivery: fully assembled furniture

Net weight: 5,6 kg

Gross weight: 7 kg

100% designed and manufactured in Poland



Oak 03



Contacts

B2C

E hello@366concept.com

M + 48 570 480 190

B2B & ARCHITECTS

E business@366concept.com

M + 48 533 326 366

OFFICE & SHOWROOM

E hello@366concept.com

M + 48 570 480 190

W 366concept.com

A Bagatela 10/5, 00-585 Warsaw, Poland

PRESS

E pr@366concept.com

MARKETING

E marketing@366concept.com

FOUNDERS

Agata Górka

E agata@366concept.com

M + 48 502 251 616

Maciek Cypryk

E maciek@366concept.com

ART DIRECTION

Agata Górka - 366 Concept

PICTURE CREDITS

366 Concept - Furniture Icons

If we have inadvertently used material without acknowledgement, we will correct the omission immediately upon notification.

No part of this catalog may be reproduced without prior written permission from 366 Concept - Furniture Icons.

© 2022, 366 Concept - Furniture Icons. All rights reserved.