

GRAND DIVE PRO PLUS



Congratulations on choosing one of the most innovative and safe hyperbaric chambers.

In addition to this manual we have an easy to follow instructional video available

<https://www.summit-to-sea.com/instructions>

Click on “Grand Dive Pro Plus”

Now that you have all the equipment to begin your treatments, it is extremely important to thoroughly read this manual before operating your chamber.

FRAME

The first thing that you will do is build the frame.
Lay out all the pieces of the frame so that you can identify them.

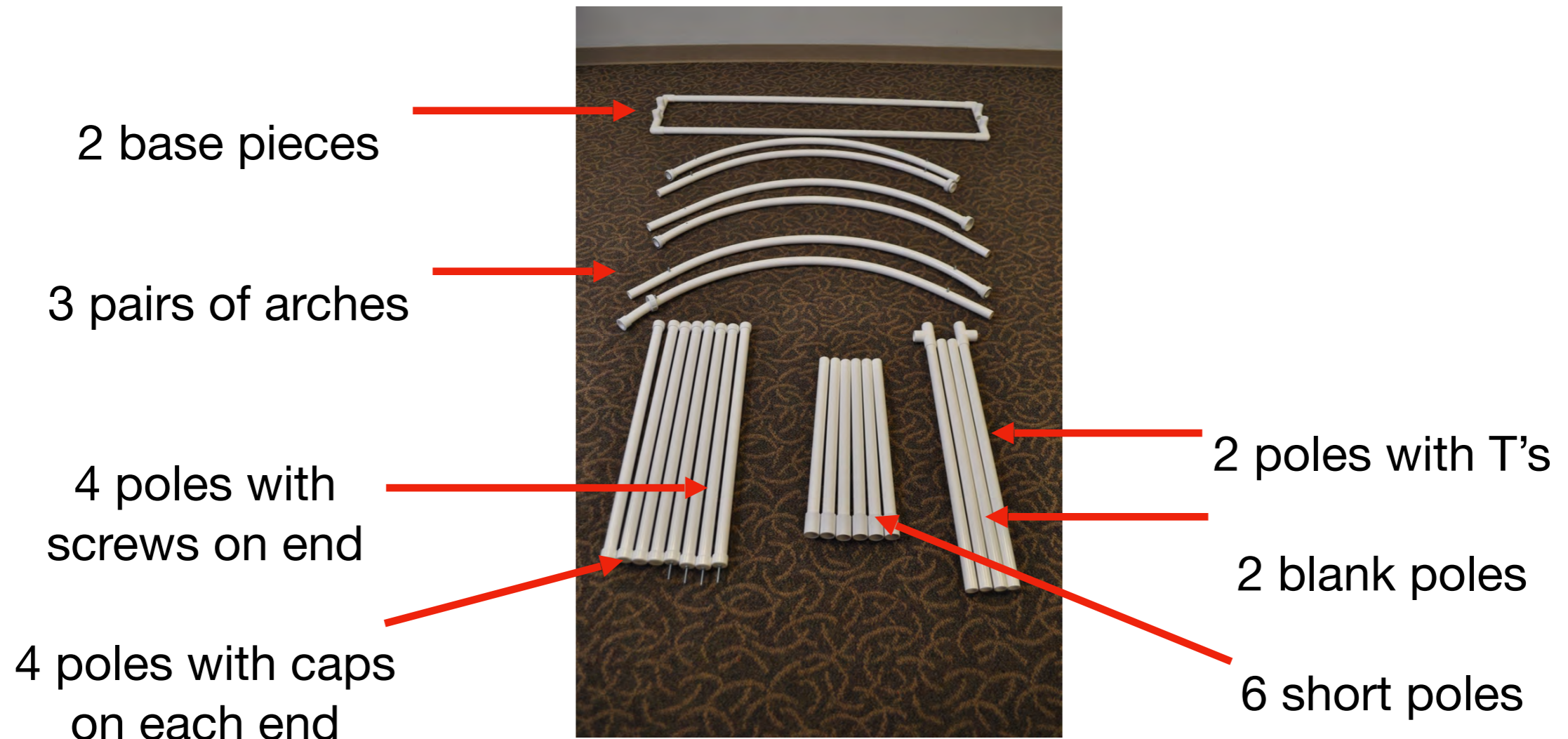

FRAME

Take the 2 base pieces and place them facing each other on the floor



FRAME

Connect the T pole with the blank pole.



FRAME

Next attach the two long poles to each base piece so it will form a rectangle



FRAME

Take the 6 shorter poles and place them in each
of the rectangle base

T



FRAME

The next step is to build the arches

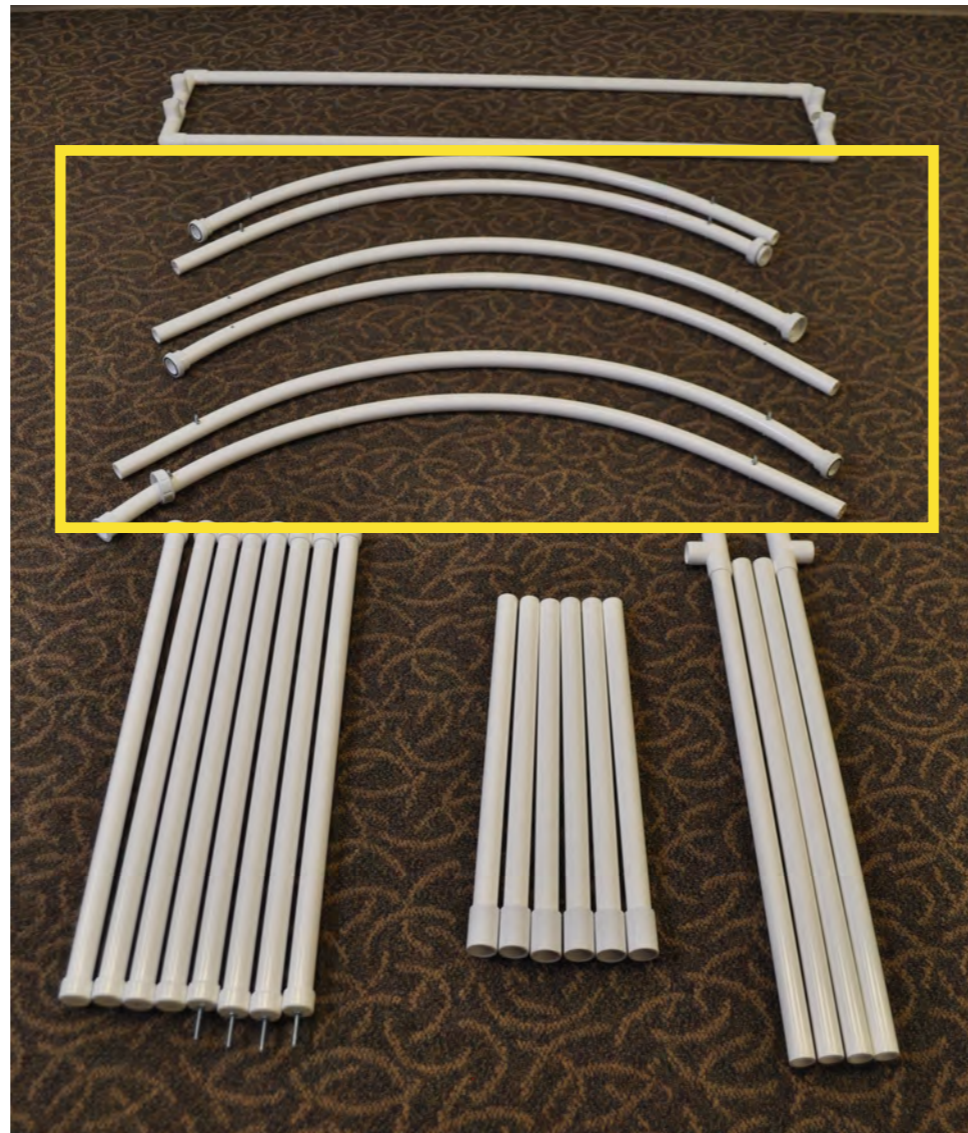

FRAME

Notice 4 of the arch pieces have screws and 2 do not have any screws. The threaded screws will face toward the center on each end of the frame.

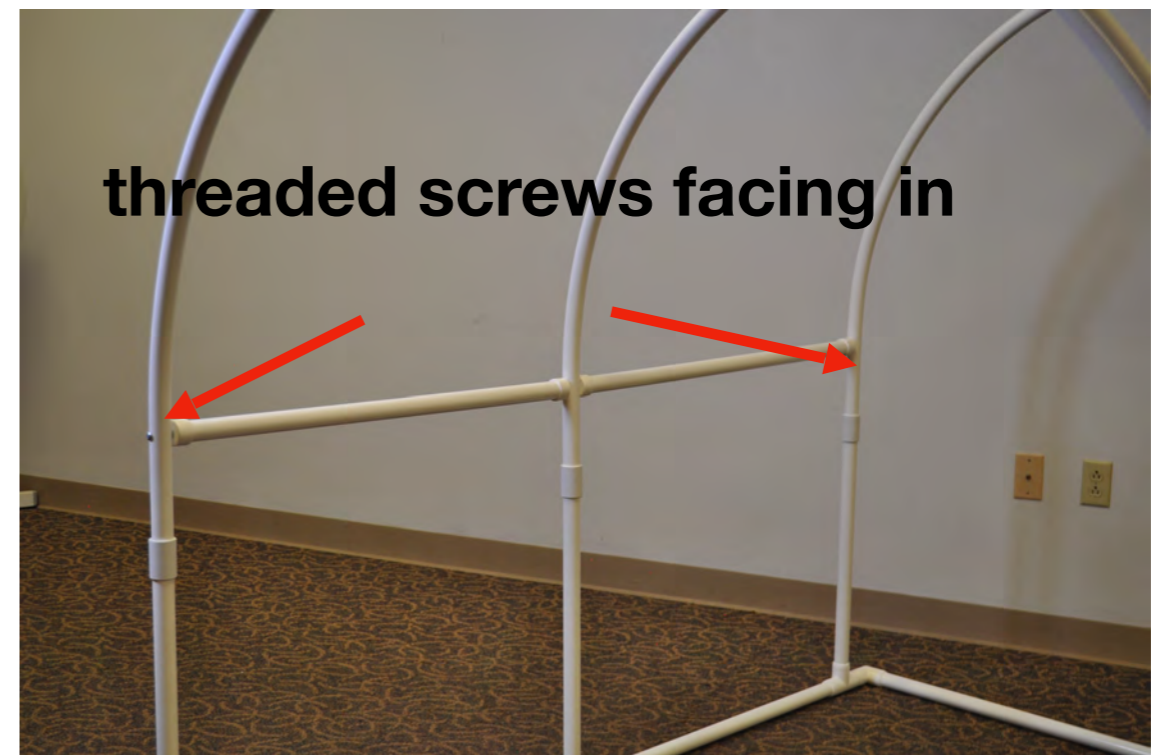
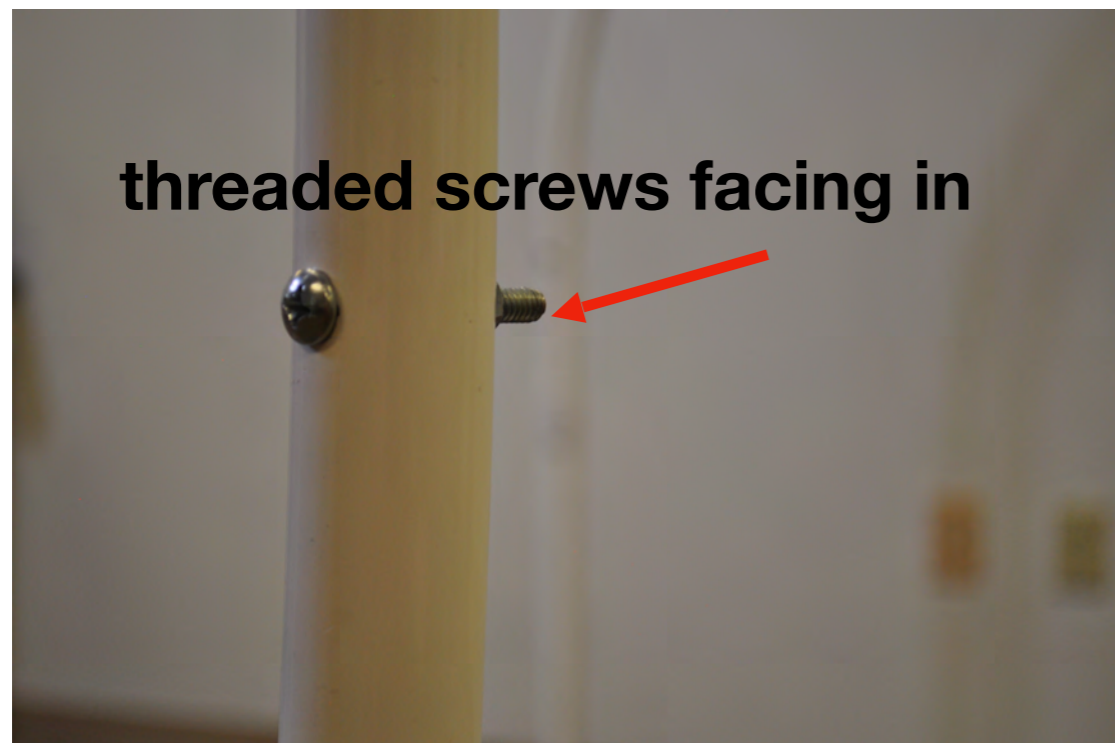

FRAME

Place each arch pair into the short vertical poles.
Then connect them by screwing the arch pair together.



FRAME

Now you will connect the horizontal poles to the arches.
Notice 4 pieces have caps on each end and 4 pieces have a cap on one end
and a screw on the other end.



FRAME

There will be 4 sets of horizontal poles to connect to the arches.
This is the configuration of each arch and pole.

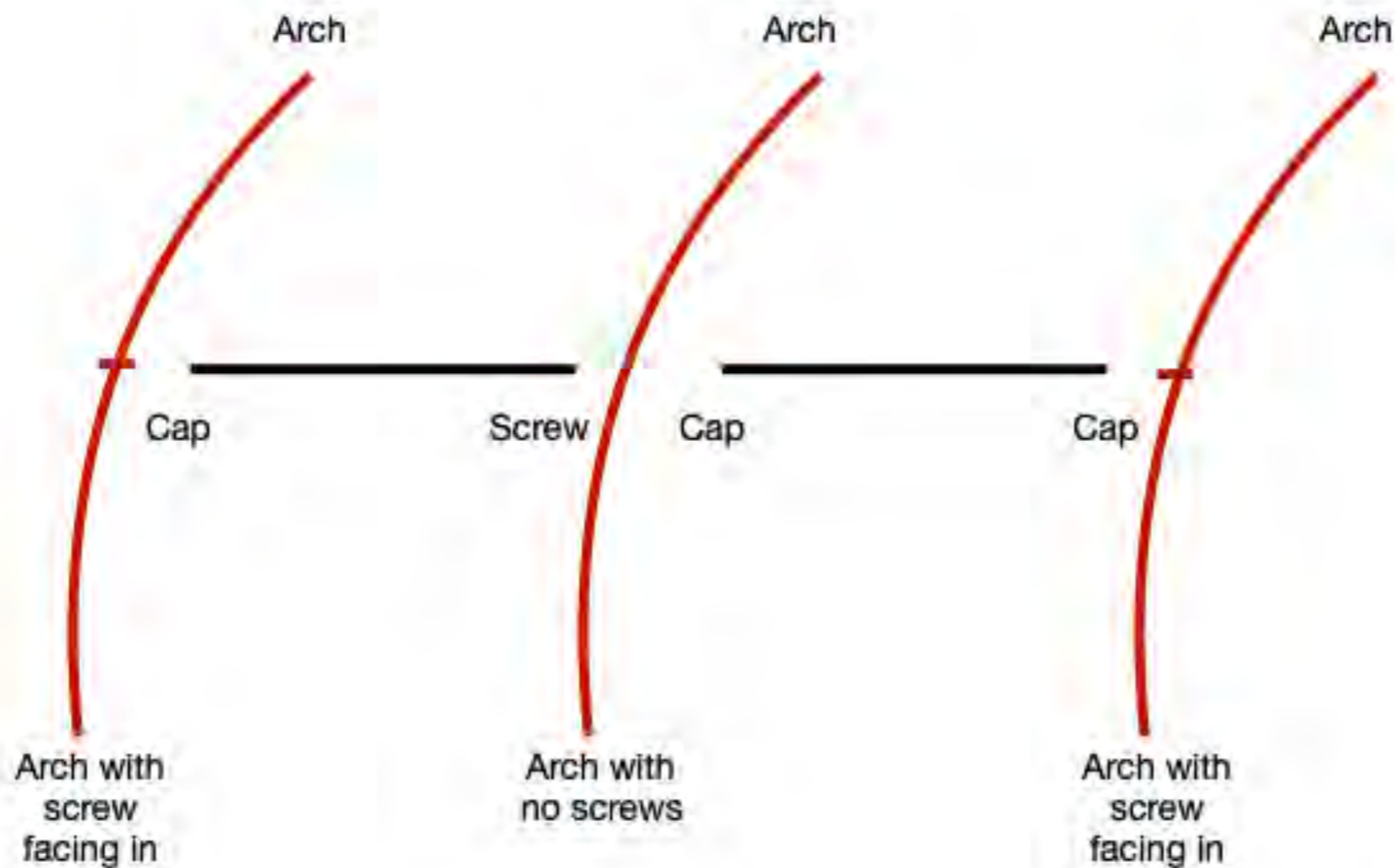

FRAME

To connect the poles to the arches you will need to use the Phillips screwdriver that is included in your packet.

First place the pole with the screw into the hole on the center arch.

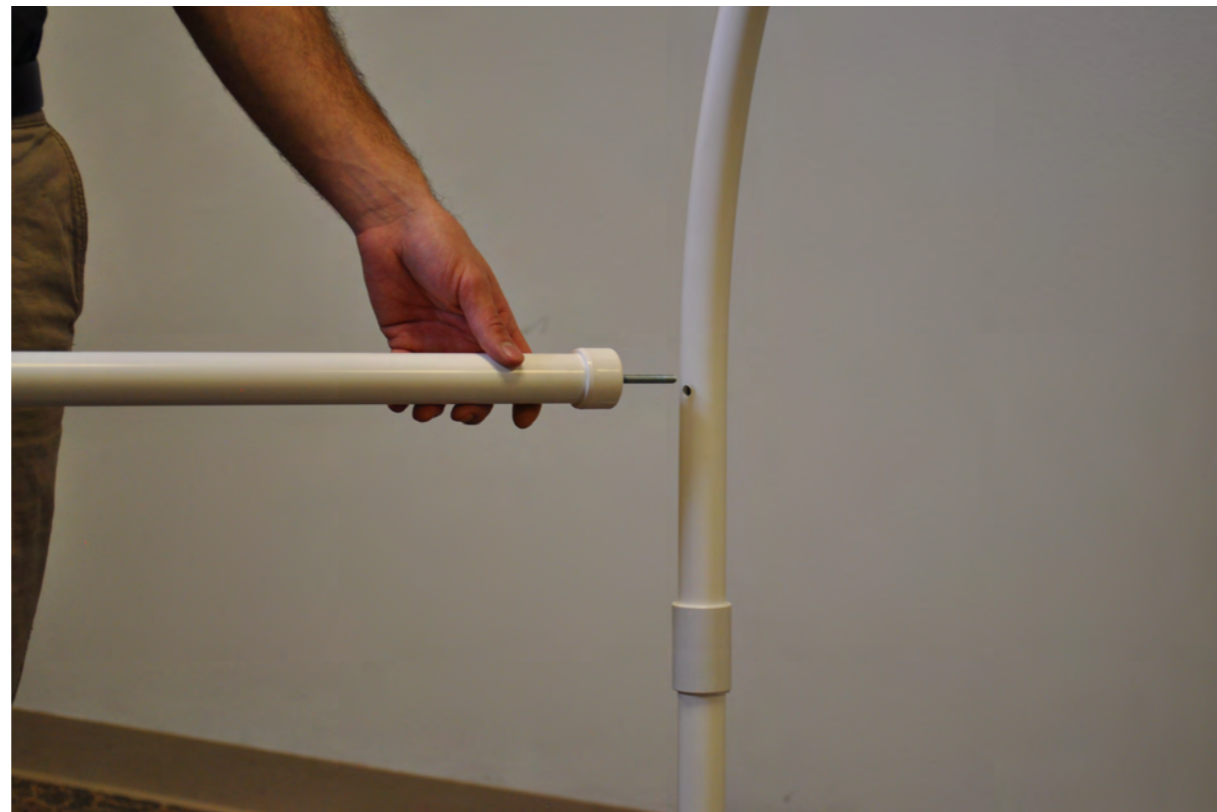

FRAME

Next place the pole with the cap end onto the threaded screw.
Using the Phillips screwdriver turn the screw until the pole
and arch are touching.
Do not over tighten.



FRAME

Then attach the second pole which has a cap on each end to the center arch.

Be sure the pole is level when attaching it.

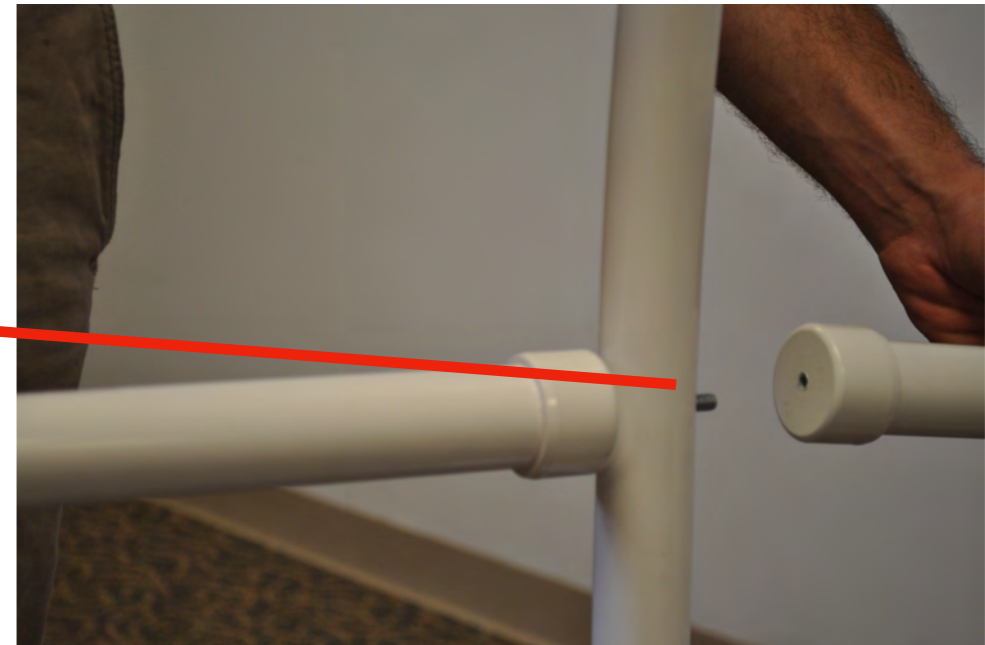
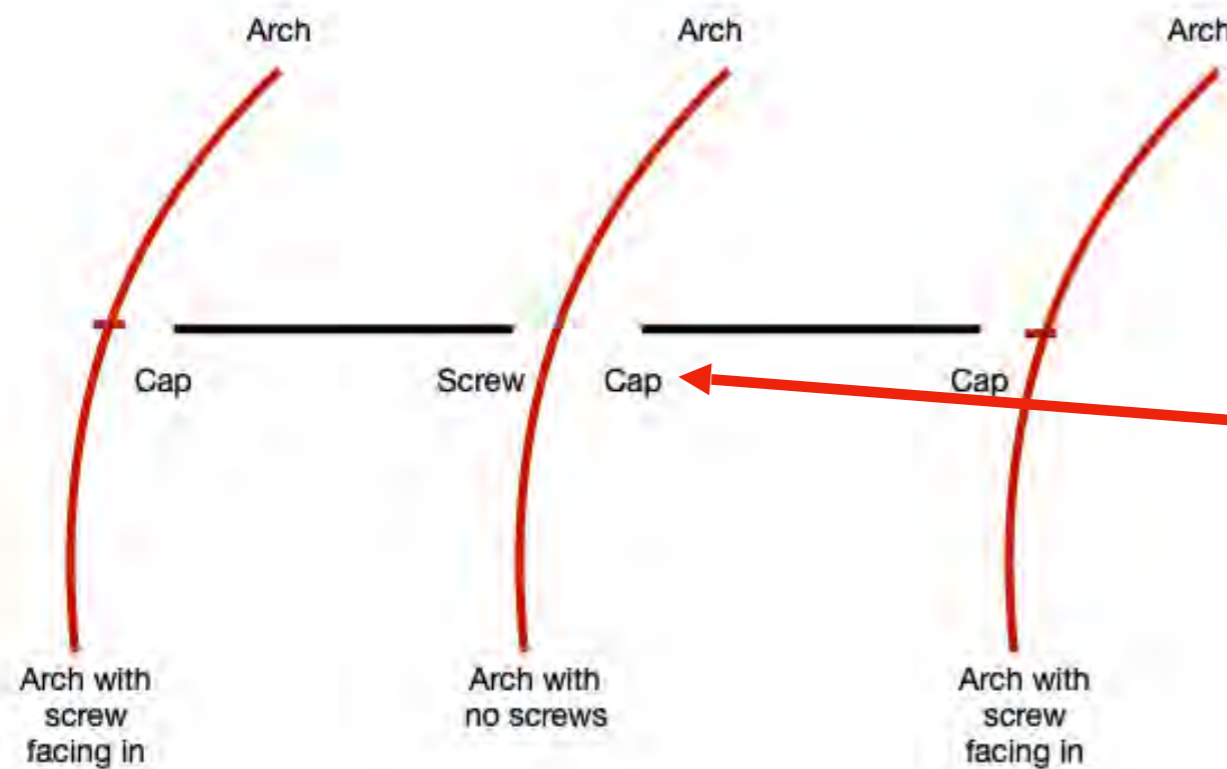

FRAME

Then attach the second pole which has a cap on each end to the third arch.

Repeat this procedure on the other side of the frame and two on top of the frame.

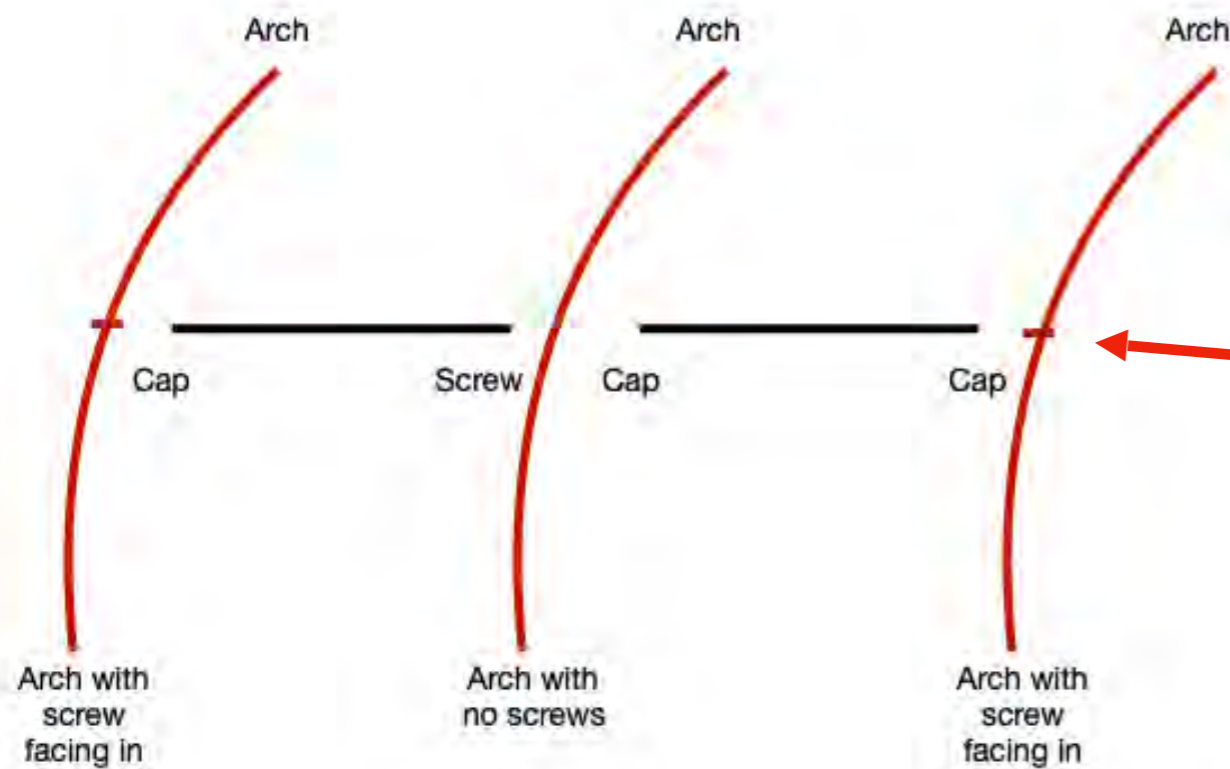

FRAME

Repeat this procedure in the other positions (2, 3 and 4)

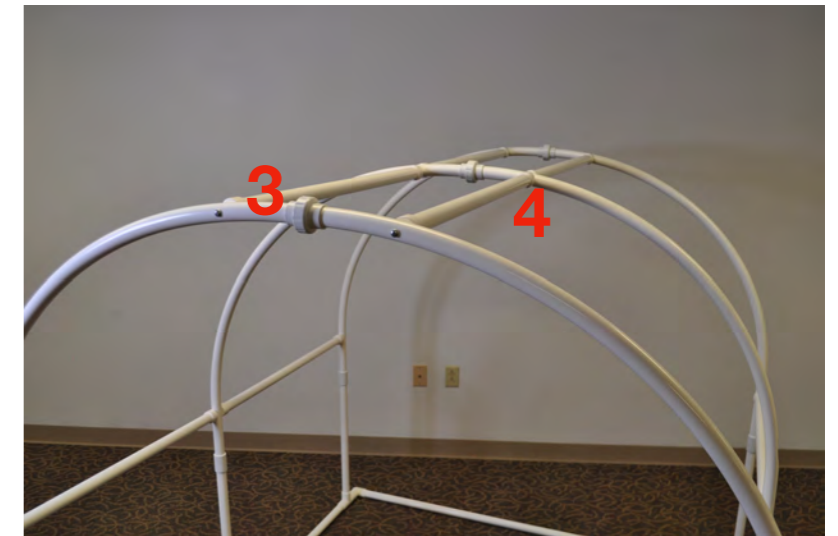

SET UP

Now it is time to connect the compressors to the electrical outlet

It is important that you do not use any wall outlet that is controlled by a light switch.

It is recommended that you use the power strip included. If you are a customer using 220 Volt 50 Hz electricity you will need to purchase your own power strip that is appropriate for your area.

SET UP

You will first plug the circuit alarm into the electrical outlet.
Next plug your power strip into the back of the circuit alarm plug.
Now plug in the 4 compressors into the power strip.

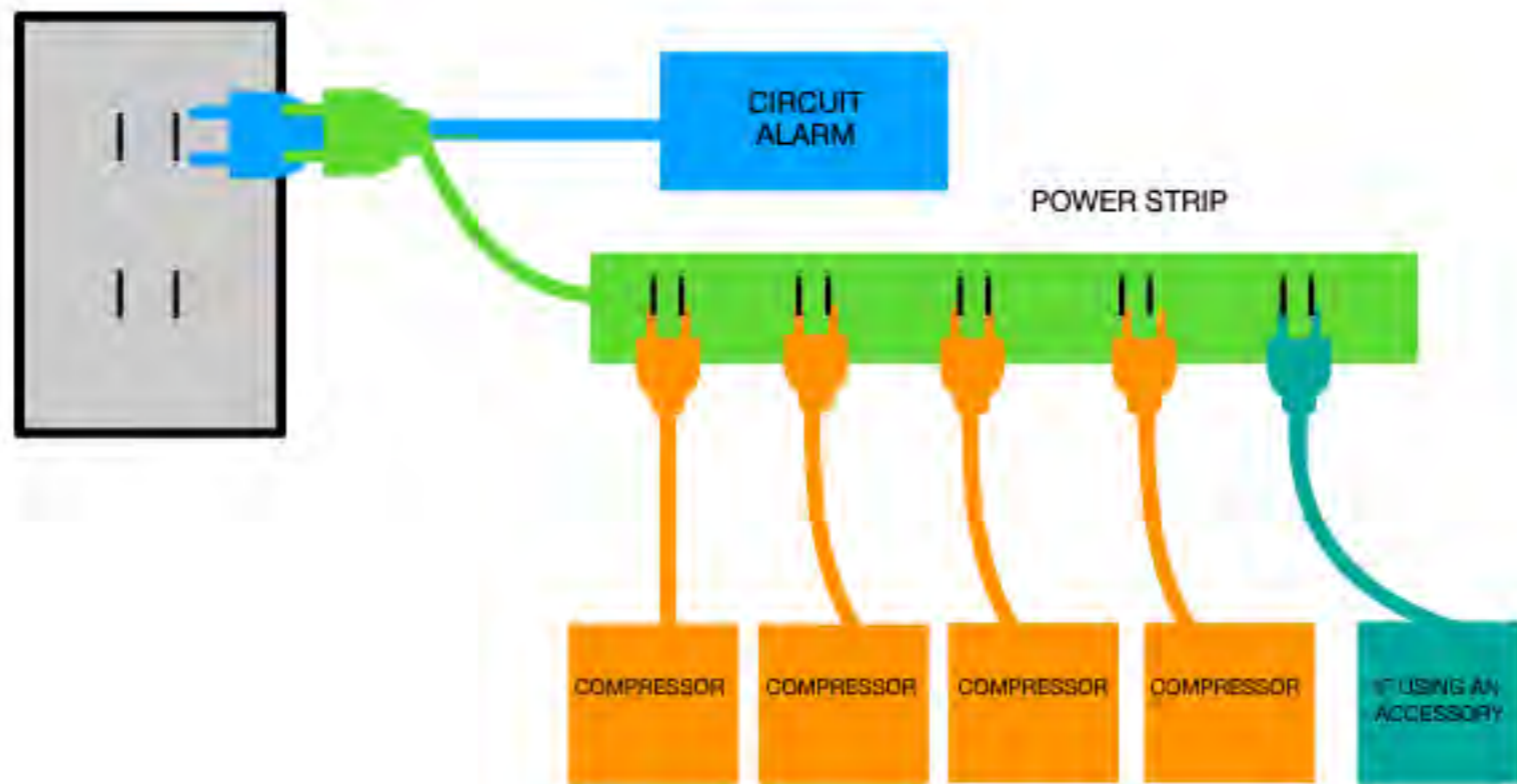

SET UP

Next you will remove the chamber from the black carry bag and place the chamber inside the frame.

You will need to make sure the end of the chamber with the zipper is facing towards the front.

Also make sure the zipper ends are facing up.



SET UP



Now you will need to close the zippers. Summit to Sea chambers have a unique zipper system.

There is an internal air-tight zipper which seals the chamber. This seal is created when the zipper slider is fully closed into the dock.



Be sure to align both sides of the teeth on the zipper a section at a time while you are closing it. Do not put any stress on the zipper teeth. If there is any resistance, back up 6", realign and then slowly continue to close it.

SET UP

Notice the picture on the left shows the slider completely closed into the dock.

If it is not completely closed it will cause a hiss and the chamber may not get to full pressure.



SET UP

Next you will close the external zipper all the way. Notice that the slider needs to be pulled past the safety strap.



SET UP

Now that you have both zippers completely closed make sure the red knob on the dump valve is in the closed position.



SET UP



Now it is time to connect the four compressor hoses to the chamber. These connections are located on the back of the chamber.

It is recommended to put a small dot of zipper lubricant on each fill valve connector.

Simply click the hose onto the fill valve.

Now you can turn on the compressors by turning on your power strip.



SET UP



Next you will want to connect the stabilizer cradles to the bottom of the chamber.

Have someone help you lift the chamber so you can slide the cradles underneath to attach to the velcro attached on the bottom of the chamber at both ends.



SET UP

Once the chamber is inflated you can use the velcro straps attached to the chamber to secure the frame. Loosely close each velcro strap.

Notice that on the top of the chamber you will take each side of the velcro and close it diagonally across the junction.



SET UP

Your chamber should look like the picture below.



SET UP

Now it is time to deflate the chamber by turning the red knob on the dump valve.

Air will slowly be released until the gauge reads zero.



SET UP

First open the external zipper by sliding the zipper pull under the safety strap. Slowly pull it to the opposite end of the zipper.

Next open the internal zipper using the pull. Again slowly pull it to the opposite end of the zipper.



SET UP

Gently take the door flap and lay it on the top of the chamber.



SET UP

If your customer prefers to lay down for their treatment or there are multiple people being treated you can place the mat inside.



SET UP

If you are using a wheelchair, gurney or comfortable reclining chair you will lay the rectangular carpet in the chamber.



SET UP

If you are pushing someone inside the chamber in a wheelchair or gurney you will want to lay down the square carpet over the zipper opening to protect the zipper.

If possible, it is recommended that someone backs the customer into the chamber so they are facing the front of the chamber.



SET UP

If you are pushing someone inside the chamber in a wheelchair or gurney you will want to lay down the square carpet over the zipper opening to protect the zipper.

If possible, it is recommended that someone backs the customer into the chamber.
so they are facing the front of the chamber.

INFLATING

CAUTION

Make sure both the inside and the outside zippers are **completely closed** each time the chamber is in use. Failure to do this may result in damage to the chamber.

INFLATING

CAUTION

If the relief valve **does not release** air when it is at full pressure, stop your treatment and call your distributor.

The compressor must **remain on for the entire treatment** period to ensure the circulation and exchange of fresh air, which provides a safe and comfortable treatment.

DURING TREATMENT

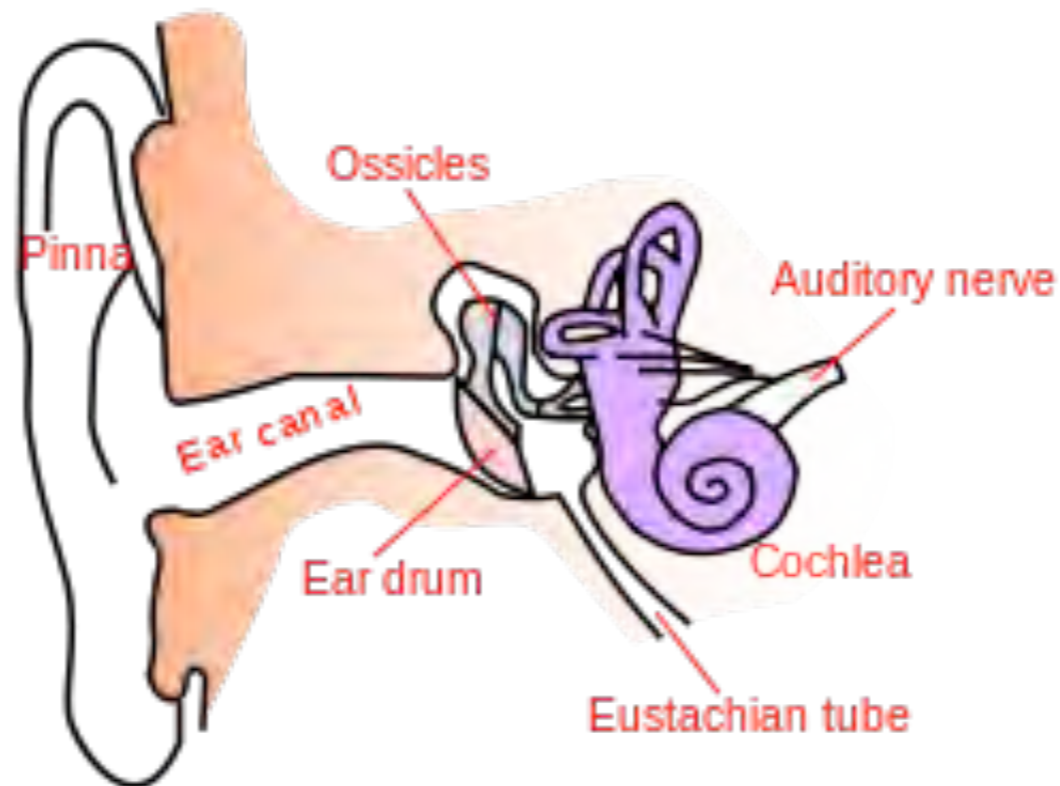

As the chamber begins to inflate, you may notice added pressure on the ears. This feeling indicates the need to equalize the pressure. The pressure feeling is similar to that of landing in an airplane. This pressure is relieved through the Eustachian tube.

There are several methods for relieving this pressure.

DURING TREATMENT

The first, is the Valsalva maneuver. Pinch your nose, close your mouth and try gently blowing out your nose. Repeat every time you begin to feel that pressure

Yawning or opening your mouth wide will also help.

Lastly, chewing gum may help relieve this pressure.

If the above suggestions do not resolve the ear pressure, open the red relief knob until the feeling of pressure is gone. Then close the red knob to continue to pressurize the chamber. The red relief knob will allow you to control the speed of pressurization to aid in equalizing the pressure on your ears.



DURING TREATMENT

WHAT TO WEAR

You may wear any type of clothing in the chamber; however, comfortable and soft clothing is typically used.
Do not wear shoes inside the chamber.

DURING TREATMENT

WHAT TO BRING INTO THE CHAMBER

Feel free to bring food, drinks, books and personal computers, or any other form of entertainment into the chamber.

It may also be helpful to have your cell phone with you.

We ask that you refrain from bringing in sharp objects such as forks or knives.

REMINDERS

CAUTION

REMEMBER THESE IMPORTANT STEPS

Be sure both zippers are **completely closed**.

Do not open the zipper until the gauge reads zero.

The **compressors must be running** during the whole time of treatment.
The relief valve must be **releasing air** when the chamber is at full pressure.

CONGRATULATIONS

Congratulations on the purchase your Grand Dive Pro Plus Chamber.

Summit to Sea believes that you have purchased one of the best chambers on the market and will be totally pleased with the ease of use and the quality of craftsmanship.

Summit to Sea also believes that we have the best customer service of any hyperbaric chamber company on the market. We will always try our best to be available and give you prompt service.

If you have any questions regarding your chamber please contact your distributor first.

If you have additional questions please call us at 1-877-PSI-DIVE (1-877-774-3483) or contact us at www.summit-to-sea.com/support.

CHAMBER CARE

ZIPPERS

The outside zipper requires no maintenance.
Periodically, wipe the outside open zipper with a damp cloth.

CHAMBER CARE



On occasion the inside airtight zipper requires Tzip silicone lubricant. The chamber comes with this Tzip silicone to lubricate the docks where the zipper triggers are secured. It is necessary to keep this dock lubricated. Squeeze a small amount of the silicone onto your finger and spread it out on the dock. You will need to do this when it becomes difficult to seat the zipper into the dock. It is not necessary to put this silicone on the zipper itself. Periodically, wipe the open inside zipper with a damp cloth.

CHAMBER CARE

CLEANING THE CHAMBER

There is no maintenance needed other than cleaning with a non-petroleum based household cleaner.

FITTINGS & HOSES

Regularly check the fittings and hoses for cracks or damage. If you see any damage, call your distributor for a replacement part.

CHAMBER CARE

COMPRESSOR & FILTER

There is an intake filter on the compressor that has the curved plastic cover.

Instructions for cleaning the filter are on the cover.

The recommendation on the compressor cover is to replace the filter once per year based on 24 hour per day usage. Since average usage will be much less, the filter life is expected to be five years.

The output filter (black) requires no maintenance. There is a green ball visible from the top of the filter. When this ball turns red, it is time to change the filter.

Contact your distributor to reorder.

CHAMBER CARE

Filters

It is recommended that the compressor filters are changed approximately every 6 months.

To learn how to change these filters go to
www.summit-to-sea.com/filters

To order these replacement filters go to
www.summit-to-sea.com/accessories

CHAMBER CARE

White Compressor Filter

To see a video on how to change the filters go to
www.summit-to-sea.com/filters

There is a filter right under the top plate of the compressor.
It is recommended that you replace the filter every 6 months.

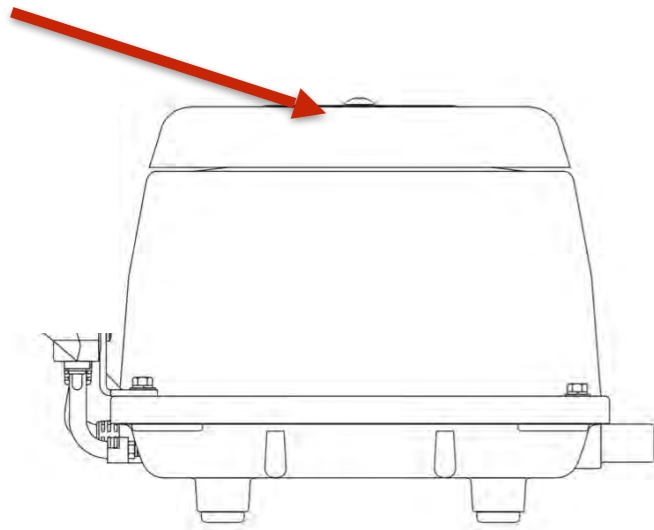

CHAMBER CARE

The .003 Micron Filter

To see a video on how to change the filters go to
www.summit-to-sea.com/filters

Follow these instructions to replace this filter
It is recommended that you replace the filter every 6 months.



Lay the compressor on its side



Push the black bulb up and give it a quarter turn to unlatch then pull down



Unscrew the silver filter element. Screw on the new silver filter



Put the black bulb back on pushing up and giving it a quarter turn to make sure it is securely connected.

CHAMBER CARE

Resetting the Safety Switch

To see a video of how to reset the safety switch go to www.summit-to-sea.com/safetyswitch

First you will need to remove the compressor cover by loosening the 4 screws with a pair of pliers and then using a Philips screwdriver to remove the screws.

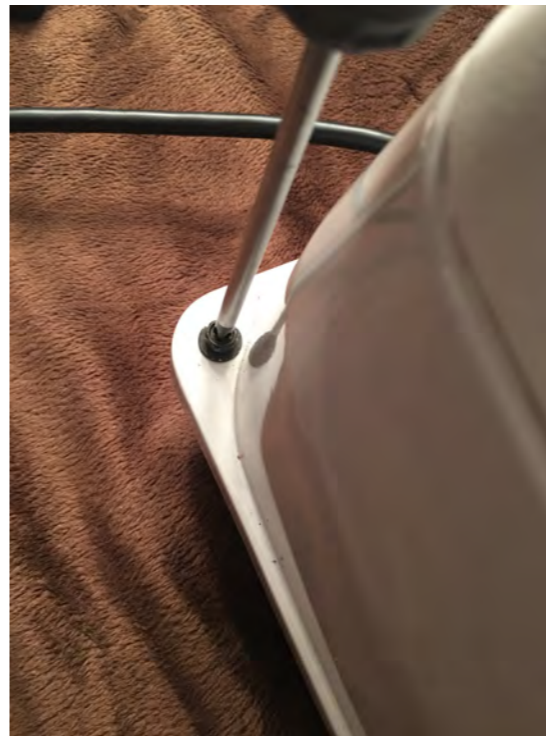
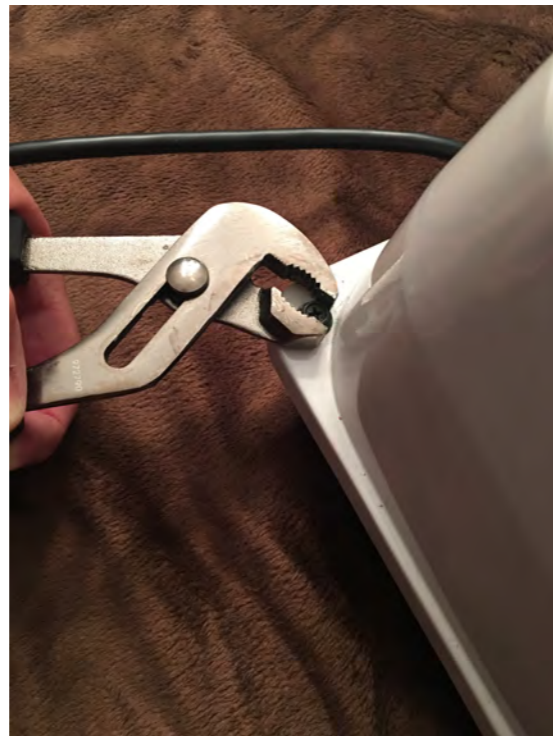

CHAMBER CARE

Resetting the Safety Switch

If the safety switch has been tripped you will see this little red button.

Move the white switch to the center of the compartment.

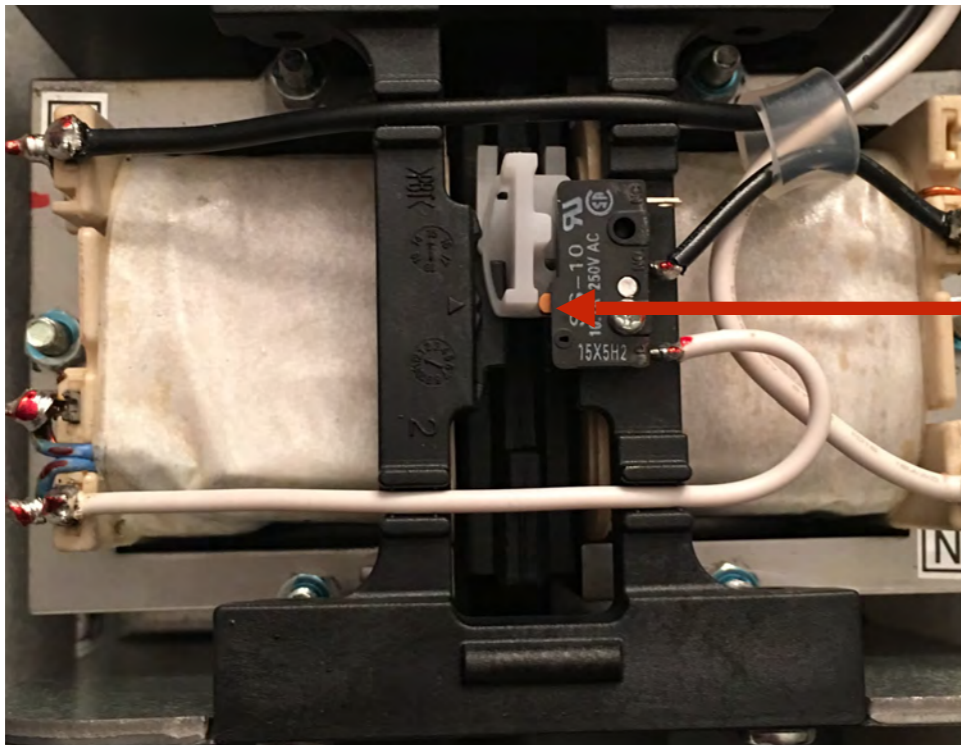

CHAMBER CARE



On occasion the inside airtight zipper requires Tzip silicone lubricant. The chamber comes with this Tzip silicone to lubricate the docks where the zipper triggers are secured. It is necessary to keep this dock lubricated. Squeeze a small amount of the silicone onto your finger and spread it out on the dock. You will need to do this when it becomes difficult to seat the zipper into the dock. It is not necessary to put this silicone on the zipper itself. Periodically, wipe the open inside zipper with a damp cloth.

CHAMBER CARE

Resetting the Safety Switch

If your compressor is jarred during shipment or operation in your home the shut off switch may be triggered. If this happens follow these instructions to reset the safety switch.

First, make sure the compressor is unplugged. You will need to remove the cover by unscrewing the four screws at the base of your compressor.

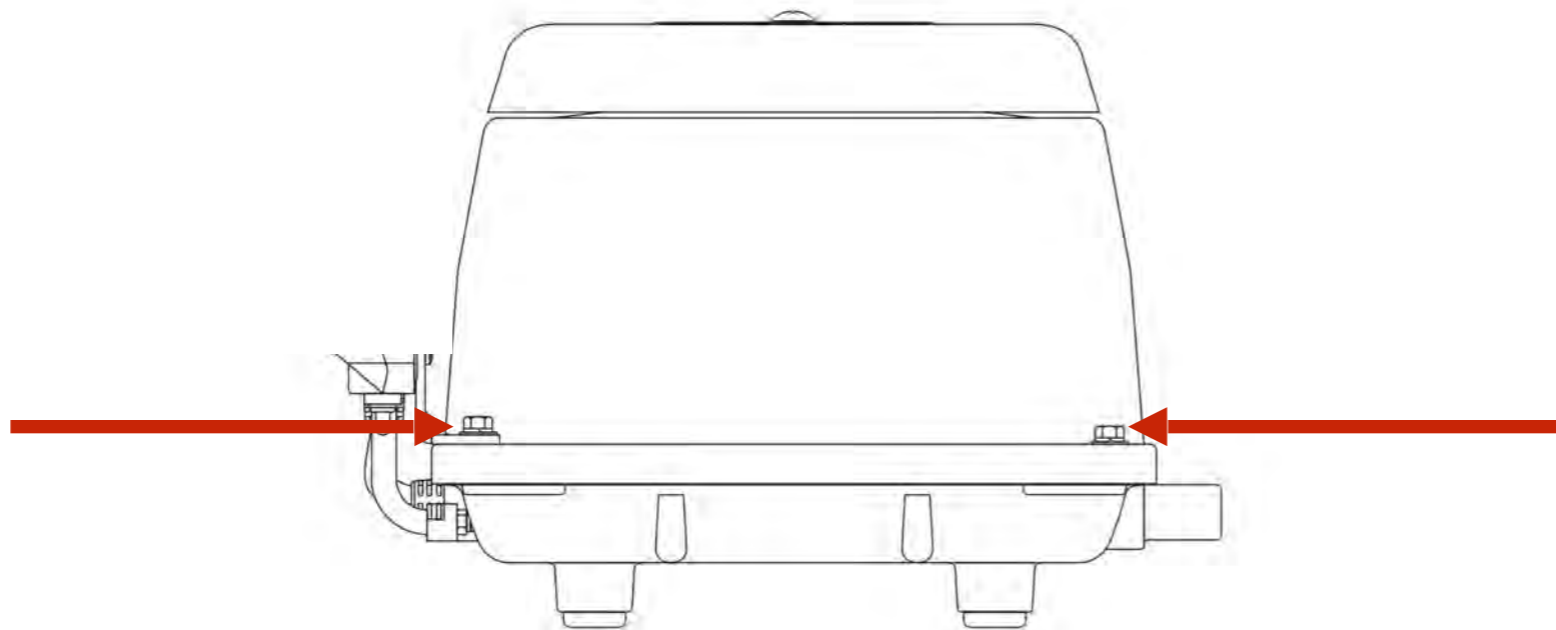

CHAMBER CARE

Resetting the Safety Switch

First you will need to remove the compressor cover by loosening the 4 screws with a pair of pliers and then using a Philips screwdriver to remove the screws.

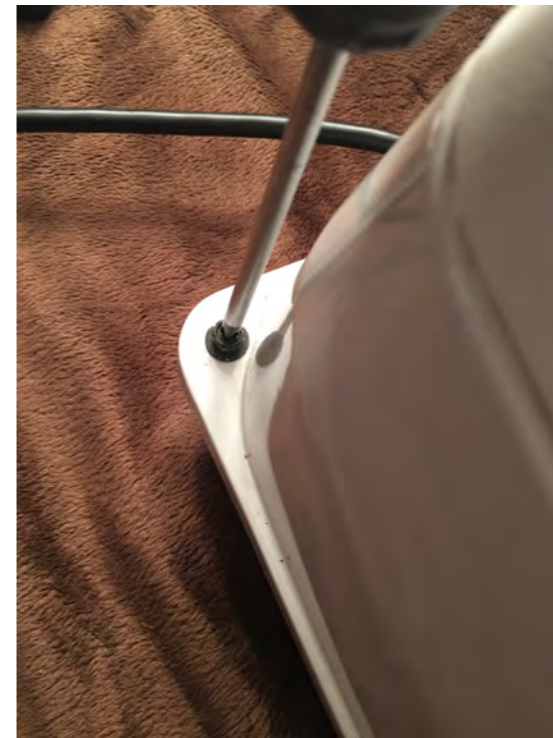
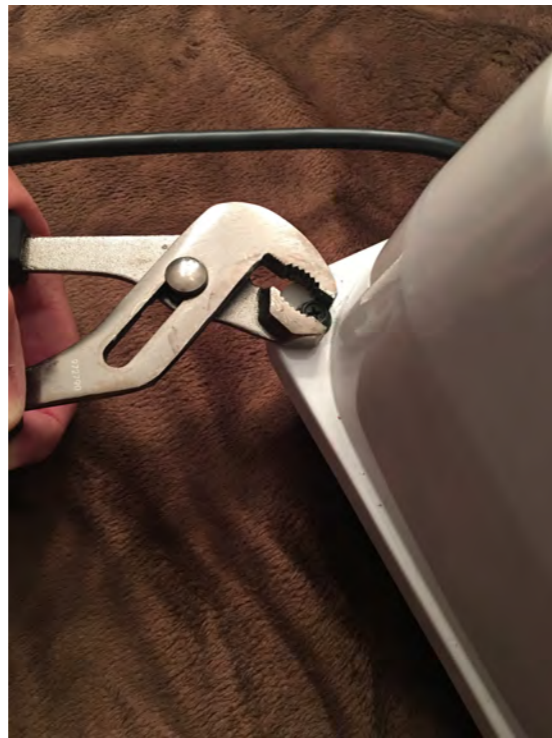

CHAMBER CARE

Resetting the Safety Switch

If the safety switch has been tripped you will see this little red button.

Move the white switch to the center of the compartment.

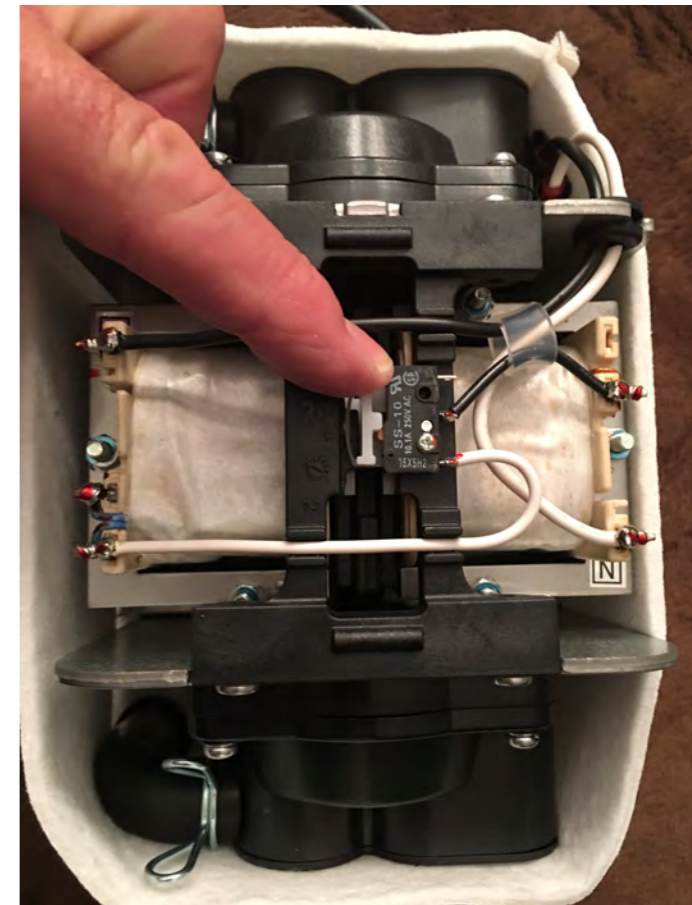
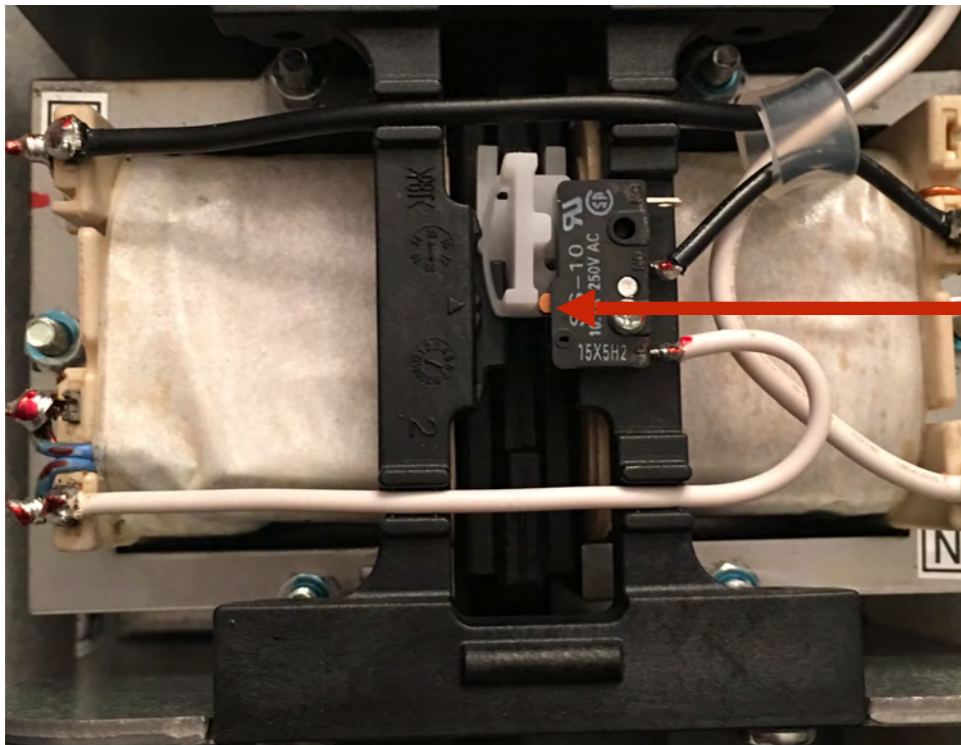

CHAMBER CARE

Resetting the Safety Switch

Next, be very careful to line up the cover with the screw holes in the base of the compressor. Tighten the screws with a Philips screwdriver. Then plug your compressors into the electric outlet.

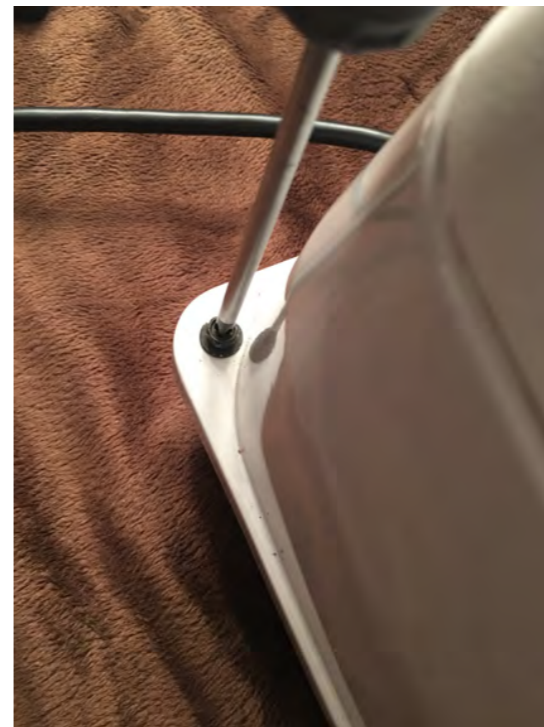

CHAMBER CARE

White Compressor Filter

There is a filter right under the top plate of the compressor.

Clean with water every 6 months.

You will want to replace the filter every year.

You can order these filters on www.summit-to-sea.com/accessories

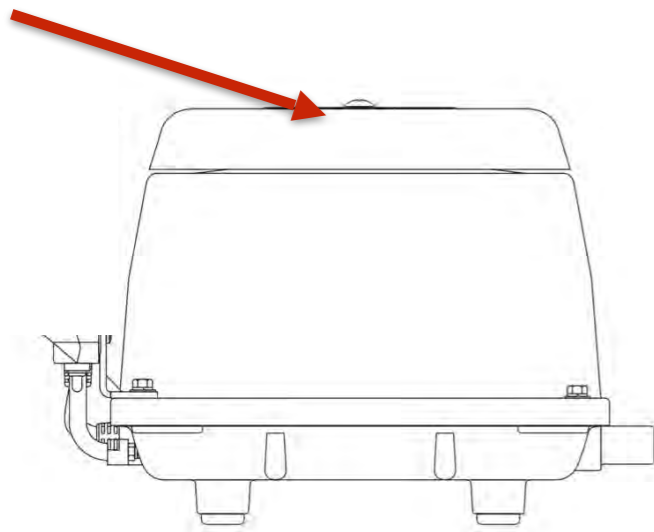

CHAMBER CARE

The .003 Micron Filter

Follow these instructions to replace this filter
You will want to replace the filter every 6 months.

You can order these filters on www.summit-to-sea.com/accessories



Lay the compressor on its side



Push the black bulb up and give it a quarter turn to unlatch then pull down



Unscrew the silver filter element. Screw on the new silver filter



Put the black bulb back on pushing up and giving it a quarter turn to make sure it is securely connected.

CHAMBER CARE

STORAGE

Prior to storing the chamber, ensure that it has been cleaned inside and out by using a non-petroleum based household cleaner.

Carefully fold the chamber ensuring all gauges and fittings are protected with bubble wrap or a similar material.

Place the chamber in the carry case and store in a dry area between 40 and 80 degrees.

Upon first reuse, run the chamber for several hours to purge the chamber from any odors that may have collected during storage.

WARRANTY

Summit to Sea warrants our products and accessories against defect for two years from purchase. The warranty covers parts and labor to repair the Summit to Sea system. Summit to Sea, at our option and sole discretion, will repair or replace the warranty item. The warranty does not cover damage as a result of misuse or modification.

Shipping to and from Summit to Sea is the customer's responsibility.

Summit to Sea has always and will continue to cover all components on our chambers — including zipper, windows, seams, valves, hoses... in other words, if it came from Summit to Sea we will stand behind our product.

EXTENDED WARRANTY

Extended warranties are available for purchase anytime within the two year warranty period. The extended warranties also cover all components on the chamber — including zipper, windows, seams, valves, hoses, etc. Contact your distributor.

1 Year Extended warranty \$995

2 Year Extended warranty \$1,250

3 Year Extended warranty \$1,500

IMPORTANT TO READ

Important Safety Considerations

You should NOT use this chamber without guidance and instruction from your health care provider.

Do NOT use the chamber if you have the following conditions:

- Common colds or flu-like symptoms
- Recent alcohol consumption
- Blocked ear canals
- Blocked sinuses
- Otic barotraumas
- Excessive CO₂ exposure

IMPORTANT TO READ

CAUTIONS

CAUTION: Federal law requires this device for sale by or on the order of a physician.

CAUTION: Do not inflate the chamber with only pure oxygen; use the compressor provided. It is designed to work safely with the chamber.

CAUTION: Inspect all seams and fittings prior to use to ensure they are secure. Failure to do so could cause leaks reducing the performance of the chamber.

CAUTION: If any unusual noise or odor is detected, immediately discontinue use and contact the manufacturer. This may be an indication of a problem with the normal operation of the unit that needs to be addressed. In most situations, a simple call can resolve the issue.

IMPORTANT TO READ

WARNING: In the unlikely event that there is a rapid decompression, the individual inside the chamber must EXHALE. Please make sure that each individual receiving treatment understands this precaution.

WARNING: Do not replace the compressor with any other model. The chamber is designed to work specifically with the compressor provided. For added safety, the compressor will not exceed the test pressure for the chamber.

WARNING: Do not tamper with the pressure regulation valves. These are factory set and there are no user adjustments. Any sign of tampering with these valves will void the warranty.

WARNING: Do not use the chamber in a manner where the chamber could roll off the surface causing a fall. Always use on a surface large enough to prevent rolling off and causing a fall.

WARNING: Never take a treatment alone. Always have someone outside the chamber to assist you.

WARNING: Do not use the electric compressor in the rain or around running water as this could cause electric shock.

WARNING: Wear comfortable clothing and lay on a mat, towel or blanket while in the chamber to limit contact with the chamber surface and to improve comfort and safety.

IMPORTANT TO READ

Pressure Regulation Valves (Relief Valves)

Summit to Sea Chambers utilizes redundant pressure regulation valves. These are factory programmed to ensure a steady, constant pressure. During treatment, there will be a steady flow of fresh air through the chamber. For proper operation, the air compressor is to be running throughout the entire treatment. This is important to ensure that CO₂ build up does not occur.

These valves exhaust the old air while maintaining the factory operating pressure. This pressure is set to 1.3 ATA (4.4 PSI) or 1.5 ATA (7.2 PSI)

WARNING: Do not tamper with the pressure regulation valves. These are factory programmed and have no user adjustments. Any sign of tampering with these valves will void the warranty.

IMPORTANT TO READ

Compressor- Ultra quiet compressors provide patented sound suppression which permits a restful and relaxing dive experience. These highly compact compressors are designed for continuous operation providing you with a longlasting solution to hyperbaric pressurization needs. This compressor is small and compact making it easy to transport. With its small carbon footprint, this compressor will easily integrate into your environment.

Oil-less 120 with a flow rate of 120 liters per minute. See compressor manual included in the compressor box.

CAUTION: Using any other compressor with the Hyperbaric Dive units will void the warranty and may cause injury to the occupant and/or the attendant.

Frame- We have designed this lightweight, highly durable frame. It is easily assembled and disassembled.

Mat-Our foldable, compact mat is made with an easy-to-clean surface. It is both comfortable and versatile.

IMPORTANT TO READ

Valves-The Grand Dive has three pressure release valves to ensure a safe and comfortable operation. This redundancy assures your safety. The Shallow and the Dive have two release valves.

Windows-The window has a five layer, one firm acrylic layer between four vinyl layers to ensure a long lasting, permanent seal.

Zipper- An airtight zipper securely seals the air pressure inside the chamber without the need to massage or manipulate the seal, along with a heavyduty zipper to ensure the integrity of the chamber.

With over thirty years of manufacturing experience of hyperbaric chambers, our group of experts have gained the experience and knowledge of hyperbaric chambers and have produced a high quality product that will meet your needs today, tomorrow, and additional products for your future.

IMPORTANT TO READ

USE CARE to avoid the use of any sharp objects that may penetrate the walls of the chamber.

WARNING: Never take a treatment alone. Always have someone outside the chamber to assist you.

CLEAN the inside of the chamber with a soft, damp microfiber cloth provided after each use.

INSPECT all hoses for leaks.

HUMIDITY - In humid climates, the chamber will create condensation. Simply dry with a soft towel.

EARS - Be sure to chew gum or swallow often during the pressurization.

ENJOY a beverage, read a book, or enjoy any other form of entertainment.

UNZIP the chamber and inspect for foreign objects.

ENSURE that all connections are tightly secured.

ENSURE the chamber is on a stable platform or on the floor.

ATTACH the compressor hose and any accessory hoses.

DURING TREATMENT - After entering the chamber, lie on the mat and get comfortable with your book, computer, etc.

INDIVIDUAL HELPER zips up the chamber.

AIR - Once the chamber is zipped tight, you will hear the air entering the chamber and see it start to inflate.

IMPORTANT TO READ

Be sure to swallow often during the pressurization process. If you cannot clear your ears, have the individual helping you temporarily stop the compressor until the pressure in your ears releases.

Once the chamber is at full pressure, you will hear the “hissing” of the exhaust valves. This is important as it will prevent CO2 build up.

It is important to relax. Sit back and let the chamber operate. Hyperbaric treatments usually last from 30-60 minutes or longer. Check with your medical provider for recommended duration.

Allow 5-10 minutes for the chamber to return to normal pressure.

As air is released, check with the occupant to ensure they are equalizing the pressure at the same speed it is being reduced. Once the sides are soft, unzip the chamber.

CAUTION: Do NOT inflate the chamber with only pure oxygen. Use the compressor provided. It is designed to work safely with the chamber.

WARNING: If, in the highly unlikely event that there is a rapid decompression, the person inside must EXHALE.

Please make sure that each person receiving a hyperbaric treatment understands this precaution.

IMPORTANT TO READ

FDA 510K CLEARANCE

Portable Mild Hyperbaric Chambers are Class II Medical Devices.

They meet the FDA 510(k) Specifications.

The chamber has been cleared by the FDA for the treatment of Acute High Altitude Sickness.

FDA WARNING

Increasing the percentages of oxygen content in the air delivery is considered the same as administering a drug under FDA regulations.

This device is intended for use with ambient air and is not to be inflated with enriched oxygen.

SUMMIT TO SEA

To order additional:

filters

zipper lubricant

zipper cleaner

www.summit-to-sea.com/accessories

SUMMIT TO SEA



Summit to Sea
Hyperbaric Chambers

PO Box 339
Mound, MN 55364
Phone 1.877.PSI.DIVE
(1.877.774.3483)
Fax 1.877.420.7622

www.summit-to-sea.com

© 2011 Summit to Sea, LLC