

# Glass Guard



Assembly instructions for Glass Guard-2424, Glass Guard-20, Glass Guard-1224,  
Glass Guard-1242, Glass Guard-12-R, Glass Guard-20-R, Glass Guard-30-R, Glass Guard-1242-L,

	<p><b>HOT GLASS WILL CAUSE BURNS</b></p>	<ul style="list-style-type: none"> <li>• Keep children away.</li> <li>• <b>CAREFULLY SUPERVISE</b> children near fire pit.</li> <li>• Alert children and adults to hazards of high temperatures.</li> <li>• <b>High Temperatures</b> may ignite clothing or other flammable materials.</li> <li>• Clothing, furniture and other flammable materials must not be placed on or near the glass guard.</li> <li>• <b>Do not</b> leave appliance unattended while burning.</li> </ul>
<p><b>HOT SURFACE DO NOT TOUCH</b></p>	<p><b>DO NOT TOUCH GLASS UNTIL COOLED</b></p> <p><b>NEVER ALLOW CHILDREN TO TOUCH GLASS</b></p>	

## What Is Needed

- Phillips Screwdriver
- Soft leather gloves for handling glass panels
- Soft non-abrasive surface for assembly
- Two people are recommended for assembly

## Included in this Kit (Note: Included items differ for each kit. See below for your specific model)

- **Glass Guard-2424, Glass Guard-20:**
  - 4 Glass panels of equal length
  - 8 Corner brackets; 4 top, 4 bottom
- **Glass Guard-1224, Glass Guard-WV, and Glass Guard-1242:**
  - 2 Long, 2 short panels.
  - 8 Corner brackets; 4 top, 4 bottom
- **Glass Guard-12-R, Glass Guard-20-R:**
  - 4 round panels of equal length
  - 8 rounded brackets; 4 top and 4 bottom
- **Glass Guard-30-R:**
  - 5 round panels of equal length
  - 10 rounded brackets; 5 top and 5 bottom
- **Glass Guard-1242-L:**
  - 2 Long panels, 2 medium panels, 2 short panels
  - 12 Corner brackets; 6 top, 6 bottom

### Corner Brackets:

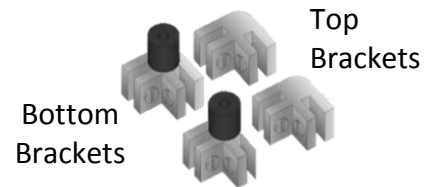

## Table of Contents:

<u>Instruction Title</u>	<u>Pages:</u>
• Glass Guard-2424, Glass Guard-20, Glass Guard-1224, Glass Guard-WV, and Glass Guard-1242.....	2
• Glass Guard-12-R, Glass Guard-20-R .....	3
• Glass Guard-30-R .....	4
• Glass Guard-1242-L .....	5
• Care and Usage Tips and Limited Warranty Information .....	6

# Installation Instructions for Glass Guard-2424, Glass Guard-20, Glass Guard-1224, Glass Guard-WV and Glass Guard-1242



**HOT SURFACE  
DO NOT TOUCH**

**HOT GLASS WILL CAUSE  
BURNS**

**DO NOT TOUCH GLASS  
UNTIL COOLED**

**NEVER ALLOW CHILDREN  
TO TOUCH GLASS**

**WARNING: Always perform assembly on a soft, non-abrasive surface. Two people are recommended for assembly and installation!**

**HINT: For rectangular, square and round burners it is recommended to assemble guard upside down and flip over after it is fully assembled.**

1

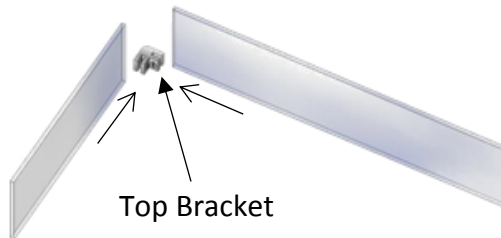

Top Bracket

- Loosen set-screws in **TOP BRACKET** and slide a short and long piece of glass into it. (for square glass kits, all panels will be equally sized)

2

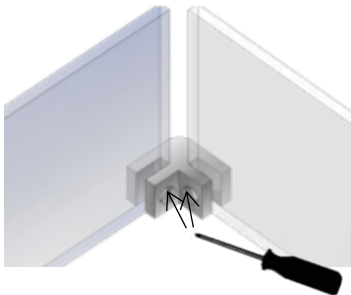

- Make sure the top edge of the glass is flush with the bracket.
- Ensure small silicone pad is in place on tip of set screws, never secure with metal screw directly to the glass. Over-tightening may break glass!**
- Tighten set-screws until snug.

3



- Repeat steps 1 and 2 for remaining three corners.

4

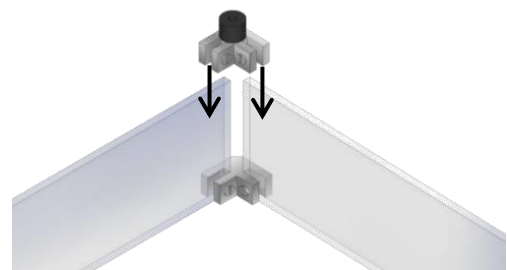

- Loosen set-screws and place **BOTTOM BRACKET** onto glass. The rubber standoff should position glass flush with bracket edge. Secure all screws, making sure to not over-tighten.
- Secure remaining three bottom brackets using the same procedure.

5

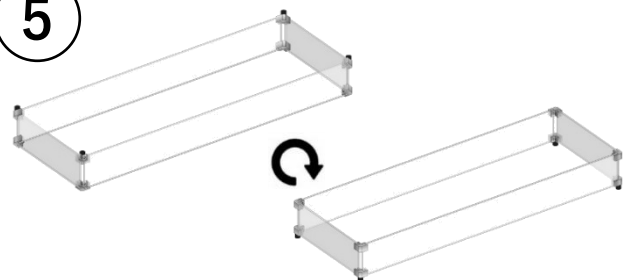

- Carefully, using two people, flip the assembly over. Gently set the glass guard onto fire pit.

# Installation Instructions for Glass Guard-12-R, Glass Guard-20-R



**HOT SURFACE  
DO NOT TOUCH**

**HOT GLASS WILL CAUSE  
BURNS**

**DO NOT TOUCH GLASS  
UNTIL COOLED**

**NEVER ALLOW CHILDREN  
TO TOUCH GLASS**

**WARNING: Always perform assembly on a soft, non-abrasive surface. Two people are recommended for assembly and installation!**

**HINT: For rectangular, square and round burners it is recommended to assemble guard upside down and flip over after it is fully assembled.**

1

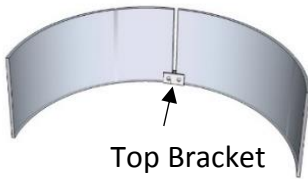

- Loosen set-screws in **TOP BRACKET** and slide two curved glass panels into it.
- **Ensure small silicone pad is in place on tip of set screws. Never secure screws with only the metal screw directly against the glass. Overtightening may break glass!**
- Tighten set screw until snug. Do not tighten all the way until all four brackets are on.

2

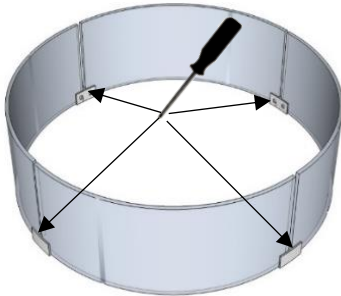

- Continue to install glass panels one at a time in the same procedure as step one until all four are in place.
- Once all four glass panels and top brackets are in place, finish securely tightening all 8 of the set screws holding the glass together.

3

Bottom Brackets

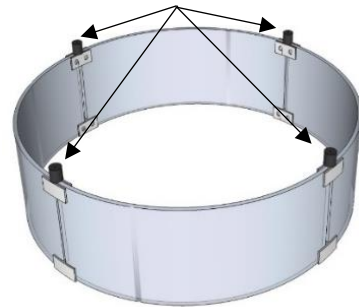

- Continue by installing the **BOTTOM BRACKETS** to the assembly and tightening the set screws in the same manner as the top brackets in previous steps.
- Remember to not overtighten screws and be sure silicone pad is adhered to set screw.

4

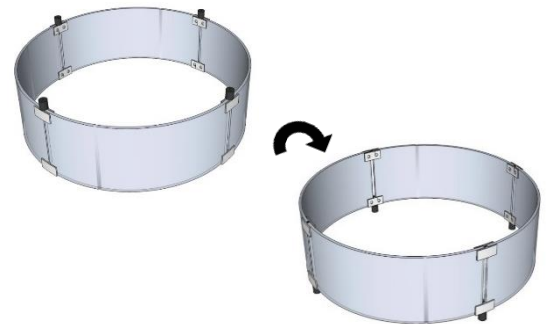

- Carefully, using two people, flip fully assembled glass guard over and place on fire pit centered around burner.

# Installation Instructions for Glass Guard-30-R



**HOT SURFACE  
DO NOT TOUCH**



**HOT GLASS WILL CAUSE  
BURNS**

**DO NOT TOUCH GLASS  
UNTIL COOLED**

**NEVER ALLOW CHILDREN  
TO TOUCH GLASS**

**WARNING: Always perform assembly on a soft, non-abrasive surface. Two people are recommended for assembly and installation!**

**HINT: For rectangular, square and round burners it is recommended to assemble guard upside down and flip over after it is fully assembled.**

1



- Loosen set-screws in **TOP BRACKET** and slide two curved glass panels into it.
- Ensure **small silicone pad is in place on tip of set screws. Never secure screws with only the metal screw directly against the glass. Overtightening may break glass!**
- Tighten set screw until snug. Do not tighten all the way until all four brackets are on.

2

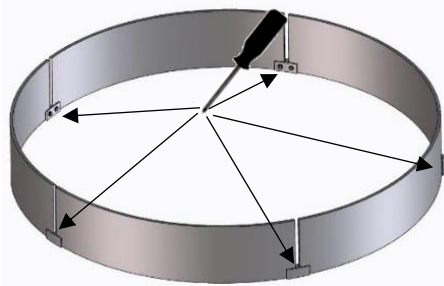

- Continue to install glass panels one at a time in the same procedure as step one until all five panels are in place.
- Once all five glass panels and top brackets are in place, finish securely tightening all 10 of the set screws holding the glass together

3

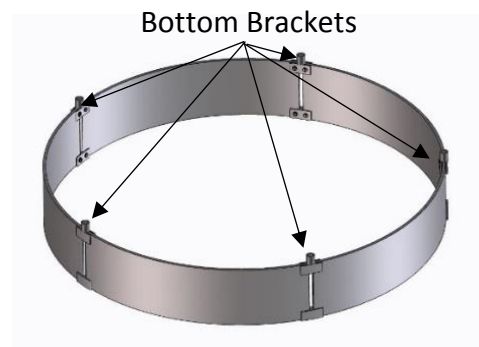

- Continue by installing the **BOTTOM BRACKETS** to the assembly and tightening the set screws in the same manner as the top brackets in previous steps.
- Remember to not overtighten screws and be sure silicone pad is adhered to end of set screw.

4

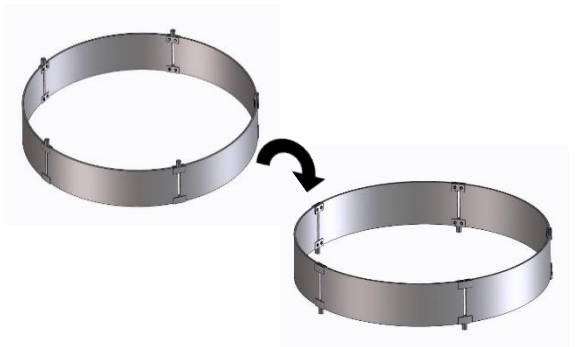

- Carefully, using two people, flip fully assembled glass guard over and place on fire pit centered around burner.

# Installation Instructions for Glass Guard-1242-L



HOT GLASS WILL CAUSE  
BURNS

DO NOT TOUCH GLASS  
UNTIL COOLED



NEVER ALLOW CHILDREN  
TO TOUCH GLASS

**WARNING: Always perform assembly on a soft, non-abrasive surface. Two people are recommended for assembly and installation!**

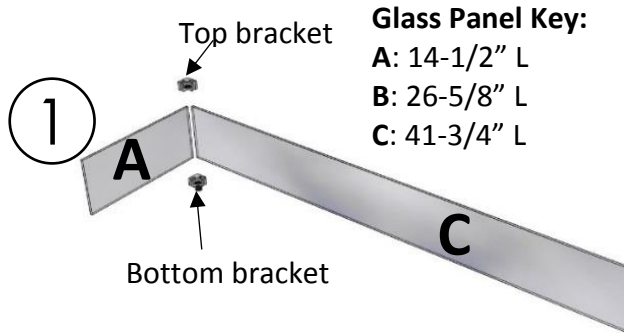

**Glass Panel Key:**

A: 14-1/2" L

B: 26-5/8" L

C: 41-3/4" L

- Loosen set-screws in top and bottom corner brackets and slide a short and long piece of glass into it.
- **Ensure small silicone pad is in place on tip of set screws, never secure with metal screw directly against glass. Over-tightening may break glass.**

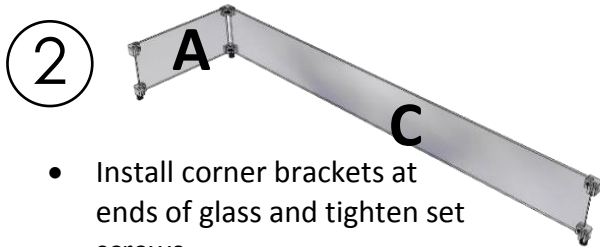

- Install corner brackets at ends of glass and tighten set screws.

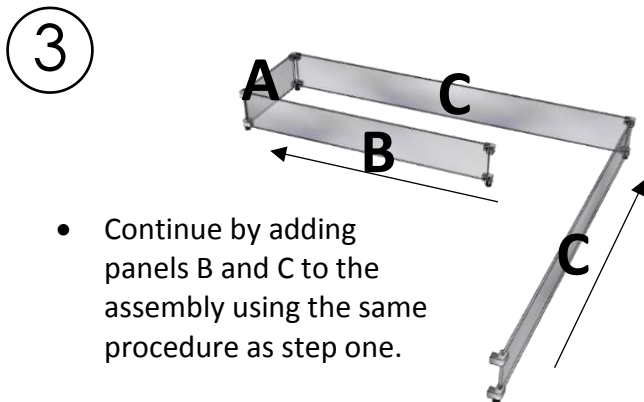

- Continue by adding panels B and C to the assembly using the same procedure as step one.

4

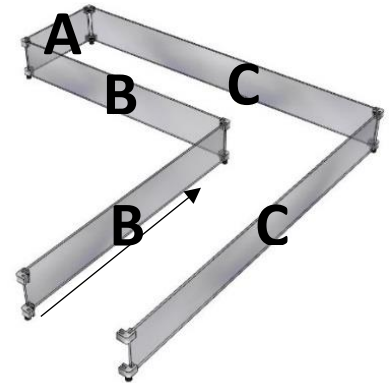

- Continue by adding panel B to assembly.

5

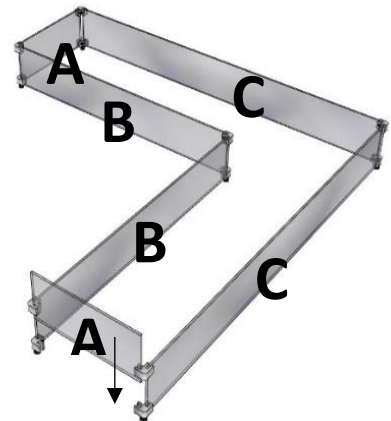

- Slide final glass panel into place and ensure all set-screws are tightened securely (**do not over tighten**).
- With the help of one or two other people, very carefully lift the glass guard up onto the fire pit top and center on the burner

## Care and Usage Tips

- Clean glass with water, white vinegar, or commercially available streak-free glass cleaner and a soft cloth.
- Never attempt to clean glass while hot.
- **DO NOT** touch glass while in operation or for 10 minutes following use. **It will be hot!**
- For a permanent installation, outdoor-rated silicone adhesive can be used to affix Glass Guard to a fire pit surface.

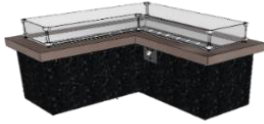

Glass Guard-1242-L

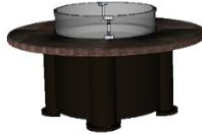

Glass Guard-12-R, Glass Guard-20-R,  
Glass Guard-30-R



Glass Guard-1224, Glass Guard-1242, Glass  
Guard-242, Glass Guard-20, Glass Guard-WV



## The Outdoor GreatRoom Company Glass Guards Limited Warranty

The Outdoor GreatRoom Company extends the following warranty for Outdoor GreatRoom Glass Guards used in the United States of America or Canada. Dealers and employees of The Outdoor GreatRoom Company have no authority to make any warranty or authorize any remedies in addition to or inconsistent with the terms of this warranty. This warranty gives you specific legal rights. You may also have other rights that vary from state to state.

The Outdoor GreatRoom Company warrants that this Outdoor GreatRoom Glass Guard (the "Product") will be free from defects in material and workmanship for a period of 90 days from its date of purchase. Stainless steel parts and assemblies carry a limited lifetime warranty. This warranty is subject to the conditions, exclusions and limitations described below.

This warranty applies only to the original owner of the Product and is non-transferable. The Outdoor GreatRoom Company obligation under this warranty does not extend to damages resulting from (1) assembly, operation or maintenance of the Product not in accordance with the Installation/Assembly Instructions, Operating Instructions and the Listing Agency Identification Label furnished with the Product; (2) installation or use which does not comply with local building codes and ordinances; (3) shipping, improper handling, improper operation, abuse, misuse, accident or unworkmanlike repairs; (4) use of fuels other than those specified in the Operating Instructions; (5) Installation or use of components not supplied with the Product or any other components not expressly authorized and approved in writing by The Outdoor GreatRoom Company; and/or (6) modification of the Product not expressly authorized and approved in writing by The Outdoor GreatRoom Company. Any of the circumstances described in the previous sentence voids this warranty. This warranty is void if the Product or any component has been removed, repaired, or replaced before The Outdoor GreatRoom Company has been afforded a reasonable opportunity to inspect the Product.

This warranty is limited to the replacement or repair of defective components or workmanship and The Outdoor GreatRoom Company may fully discharge its obligations under this warranty by repairing or replacing, at its discretion, the defective components. The Outdoor GreatRoom Company will provide replacement parts at no charge and will pay reasonable and necessary labor and freight costs related to replacing or repairing defective components under this warranty. The maximum amount recoverable under this warranty is limited to the purchase price of the Product and, if The Outdoor GreatRoom Company is unable to provide replacement or repair in an expedient and cost-effective manner, The Outdoor GreatRoom Company may discharge all obligations under this warranty by refunding the purchase price of the Product.

EXCEPT TO THE EXTENT PROVIDED BY LAW, THE OUTDOOR GREATROOM COMPANY MAKES NO EXPRESS WARRANTIES OTHER THAN THE WARRANTY EXPRESSED HEREIN. THE DURATION OF ANY IMPLIED WARRANTY IS LIMITED TO THE DURATION OF THE WARRANTY SPECIFIED ABOVE. IN NO EVENT SHALL THE OUTDOOR GREATROOM COMPANY BE LIABLE FOR ANY INCIDENTAL OR CONSEQUENTIAL DAMAGES CAUSED BY DEFECTS IN THE PRODUCT. Some states do not allow limitations on how long an implied warranty lasts, or do not allow exclusion or limitation of incidental or consequential damages, so these limitations may not apply to you.

### **To obtain service under this warranty, you must:**

1. Send written notice of the claimed condition to: The Outdoor GreatRoom Company, 14400 Southcross Drive, Suite #100, Burnsville, MN 55306.
2. Affirm that you are the original owner of the Product.
3. Provide The Outdoor GreatRoom Company reasonable opportunity to investigate the claim, including reasonable opportunity to inspect the Product prior to any repair or replacement work and before the Product or any component of the Product has been removed.