

Thank you for purchasing this OXS product.

To receive more complete service, please follow us at [www.oxsaudio.com](http://www.oxsaudio.com)

OXS

Thunder G1

V1.0

# User Manual

BENUTZERHANDBUCH · MANUAL DE USUARIO  
РУКОВОДСТВО ПОЛЬЗОВАТЕЛЯ · 使用手册  
使用手冊 · ユーザーマニュアル · 사용설명서 · دليل التعليمات

制造商: 深圳雷戈创新科技有限公司

地址: 深圳市龙岗区园山街道荷坳社区龙岗大道8288号大运软件小镇17栋105

製造商: 深圳雷戈創新科技有限公司

地址: 深圳市龍崗區園山街道荷坳社區龍崗大道8288號大運軟體小鎮17棟105

Manufacturer: ShenZhen Rango Innovation Technology Co., Ltd

Address: Room 105, Building 17th, Dayun Software Town,

No. 8288 Longgang Avenue, Longgang District, Shenzhen, China 518115

Thank you for purchasing this OXS product.

To receive more complete service, please follow us at [www.oxsaudio.com](http://www.oxsaudio.com)

## ABOUT THIS MANUAL

---

The user manual has two parts: this simple paper USER MANUAL and a detailed FULL MANUAL you can download.

### 1 USER MANUAL

See this manual for product installation, components and connections.

### 2 FULL MANUAL

You can access the FULL MANUAL or download it in document format from OXS's website. (<http://www.oxsaudio.com/support>)

Design and specifications are subject to change without prior notice.

# CONTENTS

## WHAT'S INSIDE

- Device Layout
- Remote
- Toggle Control

## HOW TO USE

### CONNECTING TO AN AUDIO SOURCE

- Connecting via HDMI eARC/ARC
- Connecting via HDMI IN
- Connecting via the USB-C cable
- Connecting via the analog cable
- Connecting via Bluetooth
- Setting the speaker as the default device

### ENABLING DOLBY ATMOS

ENG - 03

ENG - 04

ENG - 06

ENG - 07

ENG - 08

ENG - 09

ENG - 09

ENG - 10

ENG - 11

ENG - 12

ENG - 13

ENG - 14

ENG - 15

# WHAT'S INSIDE

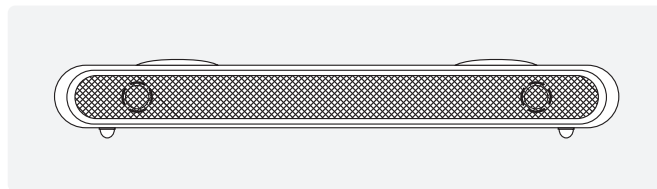

OXS Thunder Soundbar×1

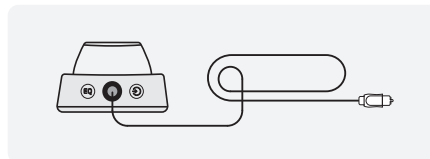

Toggle Controller×1



Detachable feet for  
soundbar angle adjustment

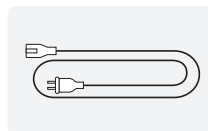

Power Cable×1

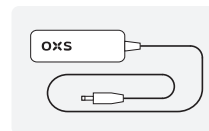

Power Adapter×1

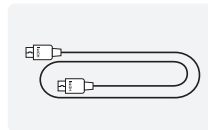

HDMI Cable×1

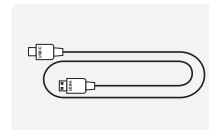







USB A to C Cable×1

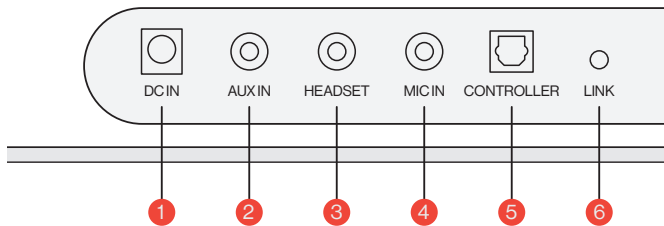
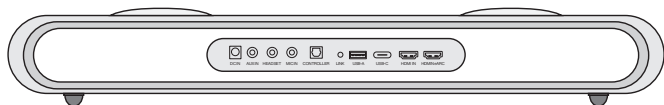





Remote Control

# DEVICE LAYOUT

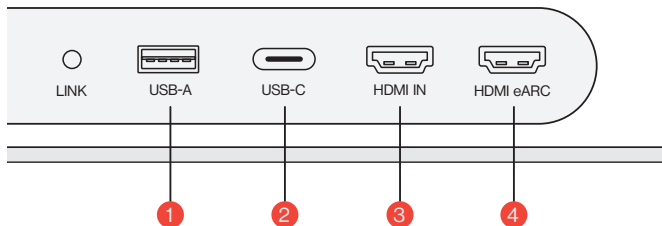
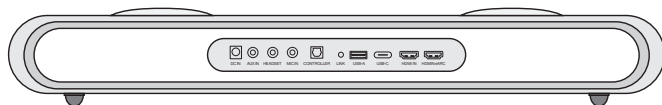

1	Power Supply		Power up the soundbar using the supplied power adapter
2	AUX IN		AUX audio input
3	HEADSET JACK		Plug in the headset or earphone wire to connect it to the soundbar
4	MIC IN JACK		Connect an external microphone to the soundbar via a 3.5 mm stereo cable
5	CONTROLLER		Plug in the toggle controller wire to connect it to the soundbar
6	LINK		Press to pair with the OXS Satellite Neck Speaker (purchase separately)



1	USB-A		Plug in the dongle to connect the OXS Satellite Neck Speaker (purchase separately)
2	USB-C		Plug in a USB (C-Type) cable to connect the soundbar to the PC
3	HDMI IN		Plug in an HDMI cable to connect the soundbar to the gaming monitor or PC
4	HDMI eARC		Plug in an HDMI cable to connect the soundbar to the gaming console

# REMOTE

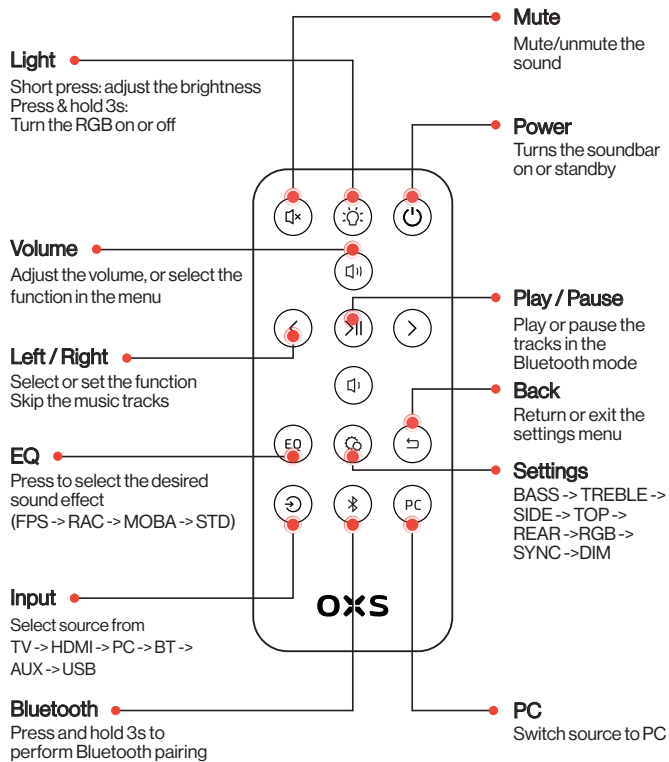

# TOGGLE CONTROL

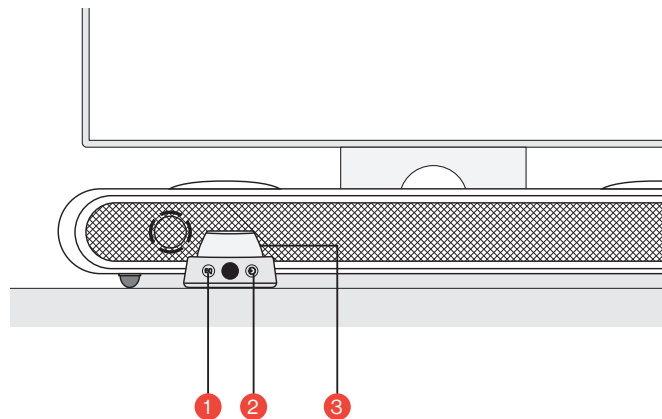

1	<b>EQ</b>		Press to select the desired sound effect (FPS -> RAC -> MOBA -> STD)
2	<b>Input</b>		Select source from TV -> HDMI -> PC -> BT -> AUX -> USB
3	<b>Main Button</b>		<b>Press &amp; hold 3s</b> Turn the soundbar on or standby
			<b>Press once</b> Mute the soundbar
			<b>Rotate to adjust the volume</b>

# HOW TO USE

## Setting it up

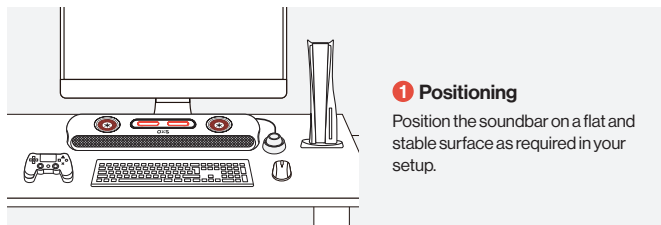

## 2 Adjusting height

The extra pair of detachable feet lets you change the soundbar height to ensure that sound is delivered with the least amount of obstruction.

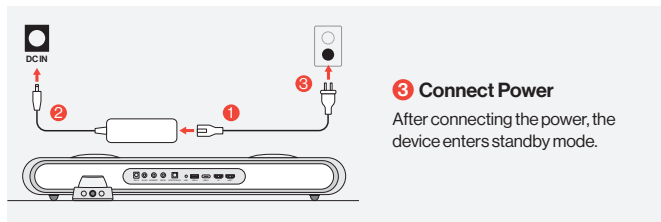
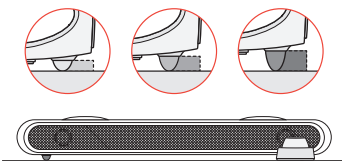

## 4 Power on

Power on the soundbar by press and hold the button.

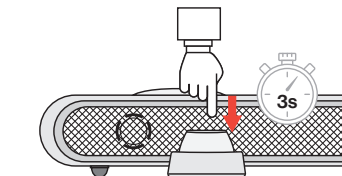

# CONNECTING TO AN AUDIO SOURCE

## Connecting via HDMI eARC/ARC

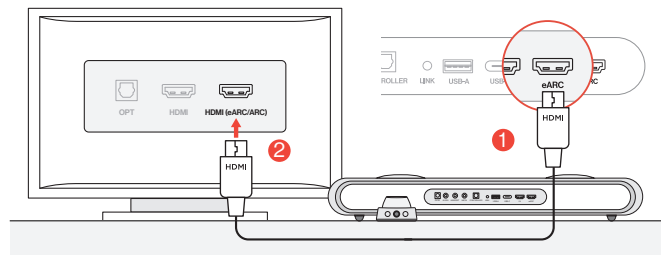

- 1 Connect the soundbar to any of the HDMI (eARC/ARC) ports on your TV using the included HDMI cable.

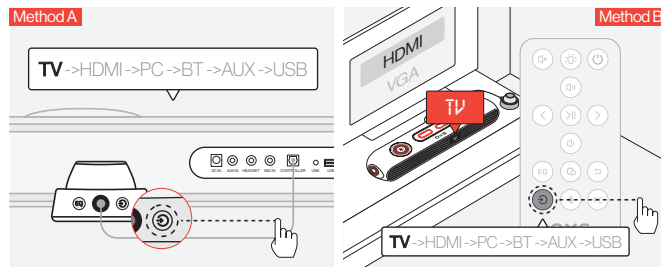

- 2 Switch the audio input to TV.

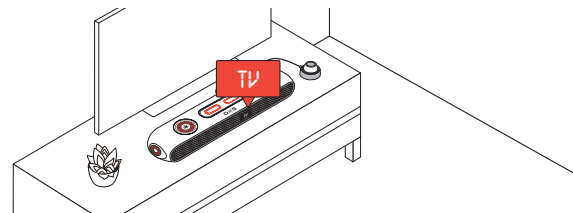

## Connecting via HDMI IN

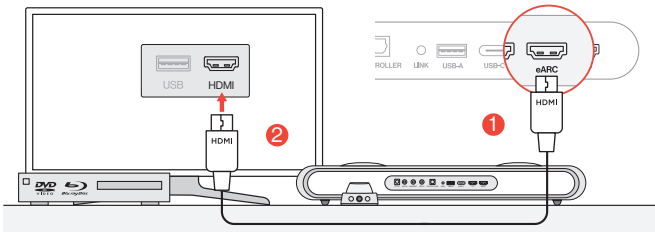

- 1 Connect any of the HDMI ports on your TV or monitor to the soundbar's HDMI OUT port.

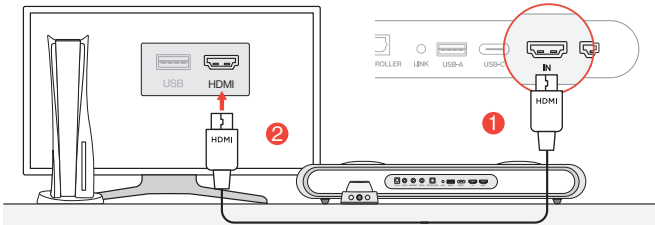

- 2 Connect any of the HDMI ports on your PC or gaming console to the soundbar's HDMI IN port.

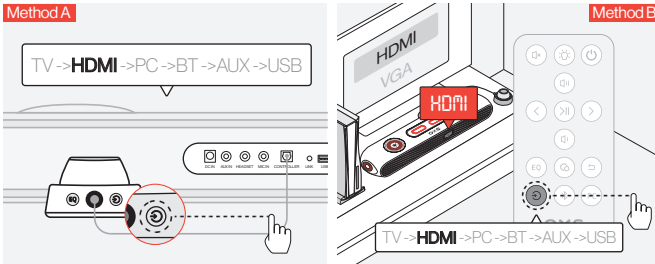

- 3 Switch the audio input to HDMI.

## Connecting via the USB-C cable

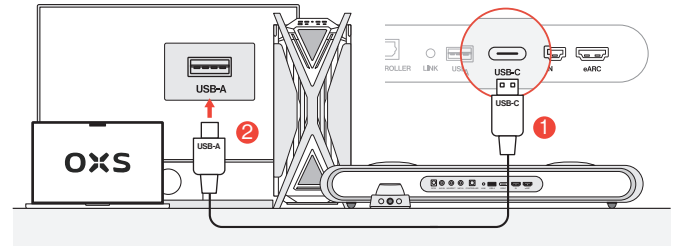

- 1 Connect the soundbar to any of the USB-A ports on your PC using the included USB-C to USB-A cable.

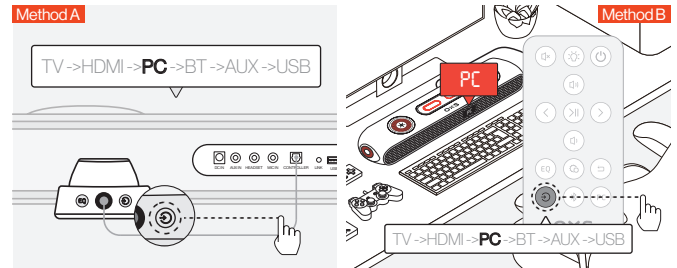

- 2 Switch the audio input to the PC.

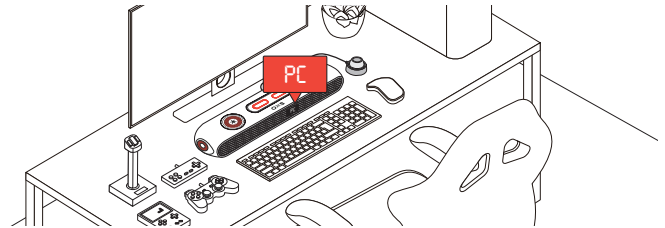

## Connecting via the analog cable

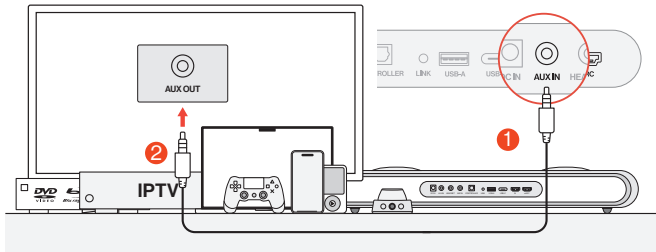

- 1 Connect the device and the soundbar using an AUX cable.

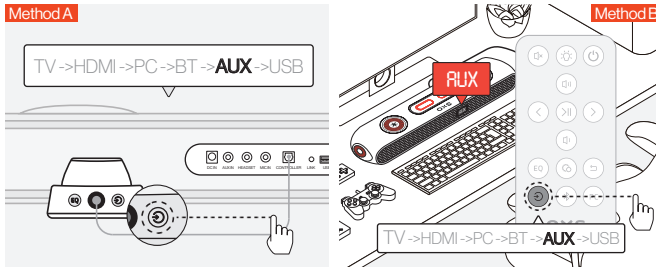

- 2 Switch the audio input to AUX.

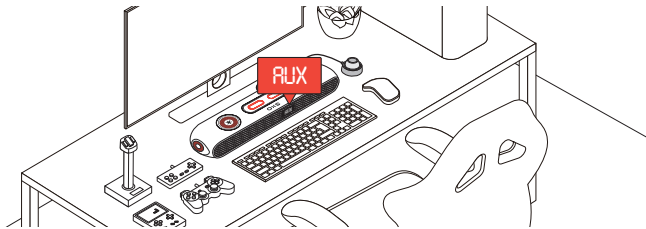

## Connecting via Bluetooth

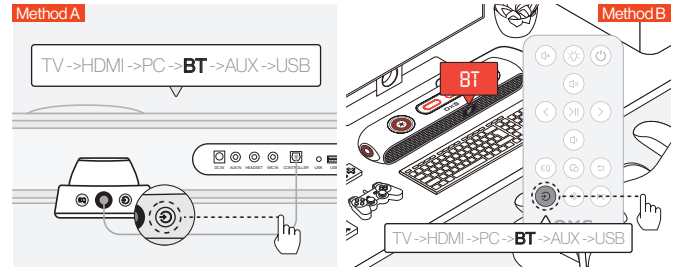

- 1 Switch the audio input to Bluetooth.

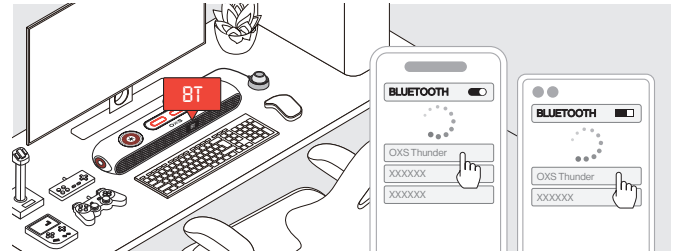

- 2 Select "OXS Thunder" on the device screen.

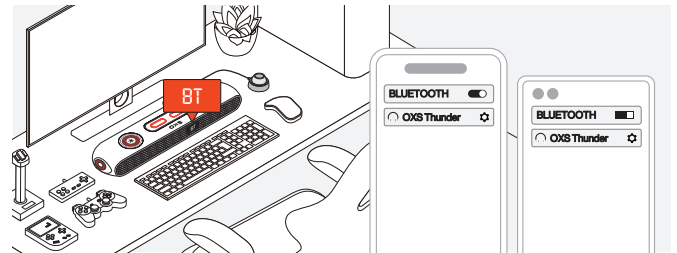

- 3 Once the connection is successful, the "BT" indicator on the soundbar will remain steady.



## SETTING THE SPEAKER AS THE DEFAULT DEVICE

If you are using the soundbar for the first time, you may be required to set up the device as your system's default playback device.

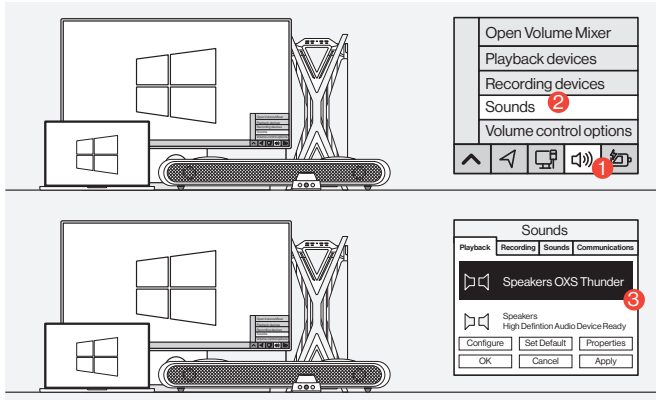

1 For Windows PC users

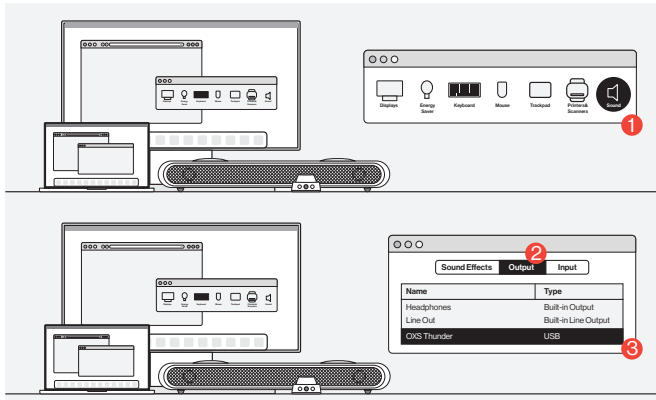

2 For MAC users

## ENABLING DOLBY ATMOS

Please be noted, Dolby Atmos is only available via HDMI output. If you are using the soundbar for the first time, you may need to enable Dolby Atmos on your gaming console or PC. For more instructions, please go to below sites:

• <https://games.dolby.com/atmos/documentation/#Platforms>

# INHALTSVERZEICHNIS

## LIEFERUMFANG

- Gerätelayout
- Fernbedienung
- Controller

DE - 02

DE - 03

DE - 05

DE - 06

## GEBRAUCHSANWEISUNG

DE - 07

## AN AUDIOQUELLE ANSCHLIEßEN

- Über HDMI eARC/ARC anschließen
- Anschluss über HDMI IN
- Anschluss über das USB-C-Kabel
- Anschluss über das analoge Kabel
- Anschluss über Bluetooth
- Den Lautsprecher als Standardgerät einstellen

DE - 08

DE - 08

DE - 09

DE - 10

DE - 11

DE - 12

DE - 13

## AKTIVIEREN VON DOLBY ATMOS

DE - 14

# LIEFERUMFANG

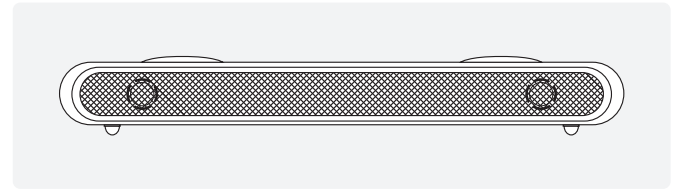

OXS Thunder Soundbar×1

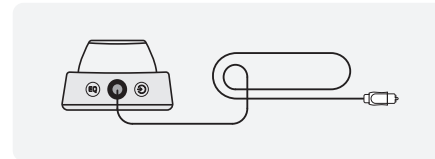

Controller×1

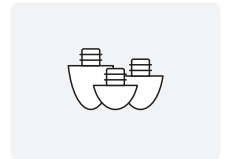

Abnehmbare Fußmatte zur Winkelverstellung der Soundbar

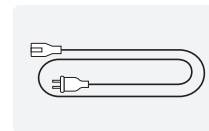

Stromkabel×1

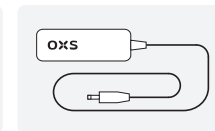

Netzadapter×1

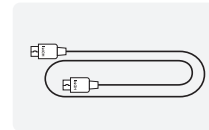

HDMI-Kabel×1

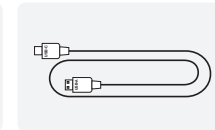

USB-A zu USB-C-Kabel×1

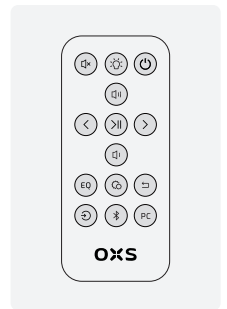

Fernbedienung

# GERÄTELAYOUT

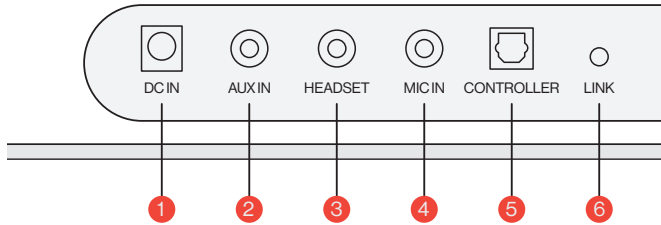
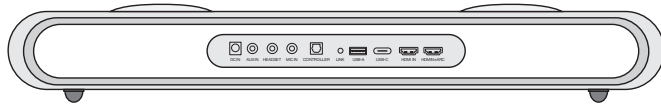

1	Netzteil		Schalten Sie die Soundbar mit dem mitgelieferten Netzadapter ein, um die Soundbar mit Strom zu versorgen
2	AUX IN		AUX-Audioeingang
3	KOPFHÖRER-ANSCHLUSS		Das Headset oder den Kopfhörer an die Soundbar anschließen
4	MIC-ANSCHLUSS		Ein externen Mikrophon mit einem 3,5-mm-Stereokabel an die Soundbar anschließen
5	CONTROLLER		Den Controller mit einem Kabel anschließen, um die Soundbar zu steuern
6	LINK		Drücken, um mit dem OXS Satellite Nackenlautsprecher (separat erhältlich) zu koppeln

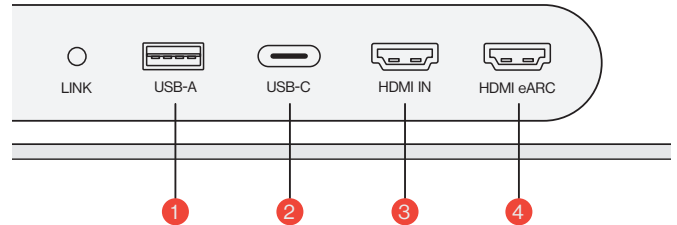
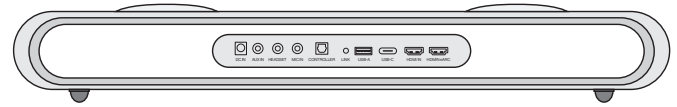

1	USB-A		Plug in the dongle to connect the OXS Satellite Neck Speaker (purchase separately)
2	USB-C		Plug in a USB (C-Type) cable to connect the soundbar to the PC
3	HDMI IN		Plug in an HDMI cable to connect the soundbar to the gaming monitor or PC
4	HDMI eARC		Plug in an HDMI cable to connect the soundbar to the gaming console

# FERNBEDIENUNG

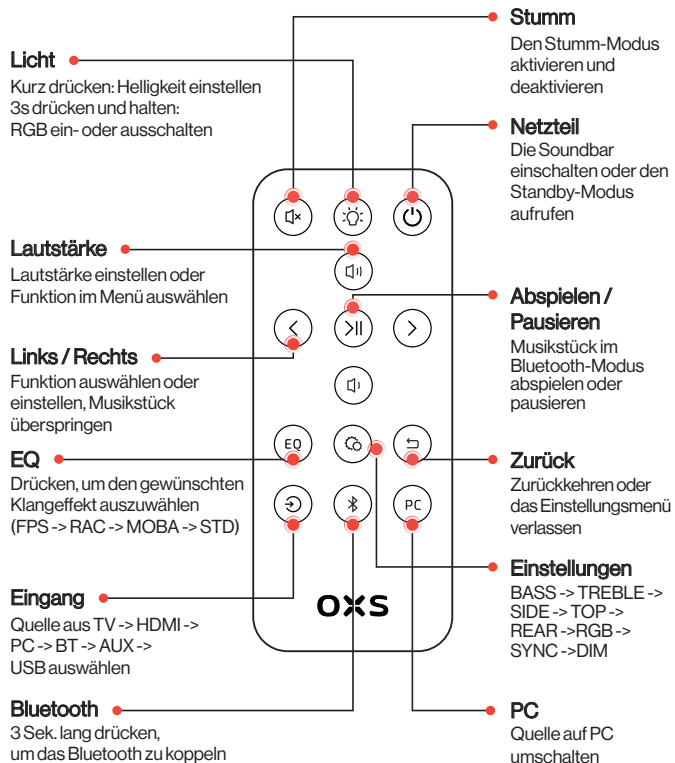

# CONTROLLER

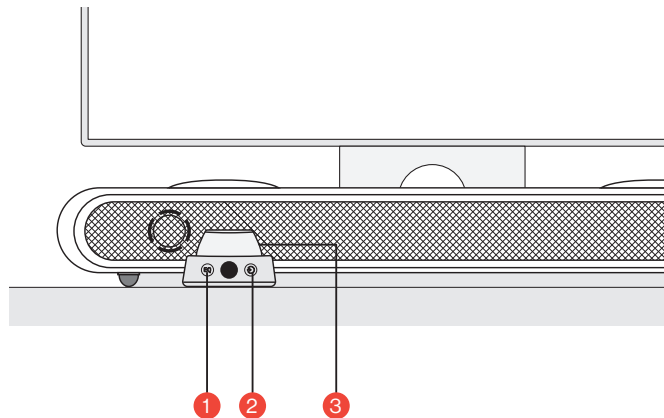

1	<b>EQ</b>		Drücken, um den gewünschten Klangeffekt auszuwählen (FPS -> RAC -> MOBA -> STD)
2	<b>Eingang</b>		Quelle aus TV -> HDMI -> PC -> BT -> AUX -> USB auswählen
3	<b>Haupttaste</b>		<b>3 Sek. lang gedrückt halten</b> Die Soundbar einzuschalten oder den Standby-Modus aufzurufen
			<b>Kurz drücken</b> Die Soundbar stumm zu schalten
			<b>Drehen, um die Lautstärke einzustellen</b>

# GEBRAUCHSANWEISUNG

## Einstellungen



## 2 Höhenanpassung

Das zusätzliche Paar abnehmbarer Fußmatte ermöglicht es Ihnen, die Höhe der Soundbar anzupassen, um sicherzustellen, dass der Klang mit möglichst geringer Behinderung übertragen wird. Nach Richtung der Fußmatte können Sie die Soundbar entweder flach oder in einem erhöhten Winkel positionieren.

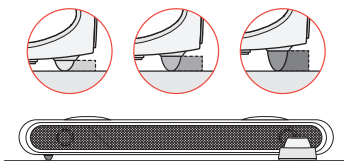

## 4 Einschalten

Schalten Sie die Soundbar ein, indem Sie die Taste gedrückt halten.

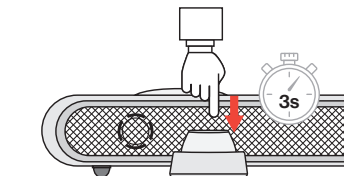

# AN AUDIOQUELLE ANSCHLIEßEN

## Über HDMI eARC/ARC anschließen

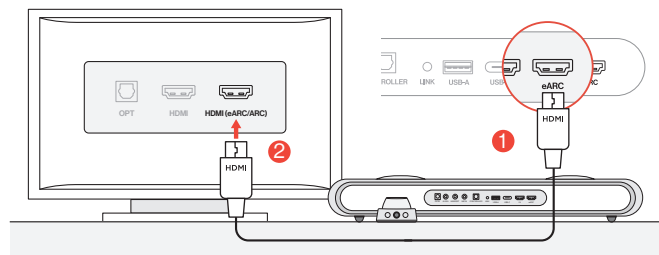

**1** Die Soundbar mit dem mitgelieferten HDMI-Kabel an einen der HDMI (eARC/ARC)-Anschlüsse anschließen.

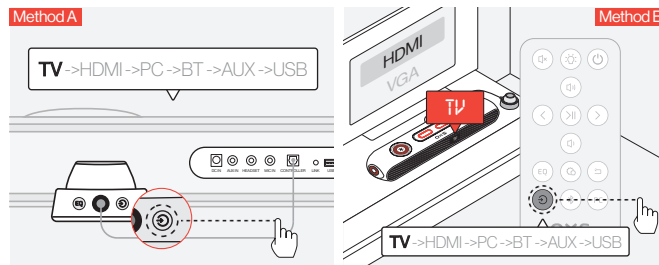

**2** Den Audioeingang auf "TV" (Fernseher) umschalten.

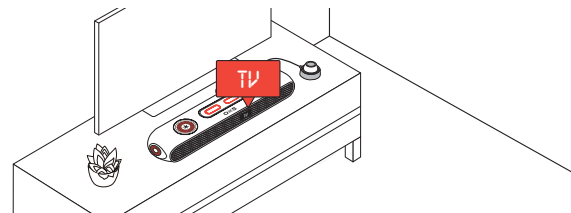

## Anschluss über HDMI IN

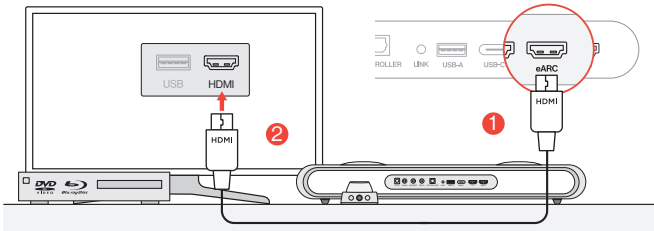

- 1 Einen der HDMI-Anschlüsse des Fernsehers oder Monitors an den HDMI OUT-Anschluss der Soundbar anschließen.

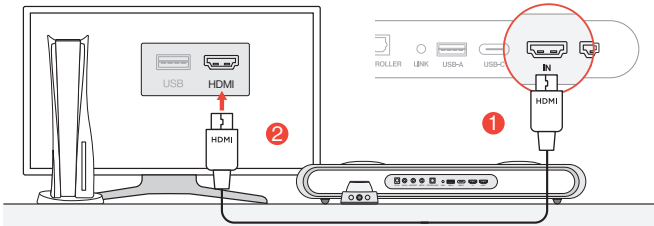

- 2 Einen der HDMI-Anschlüsse des PCs oder der Spielekonsole an den HDMI IN-Anschluss der Soundbar anschließen.

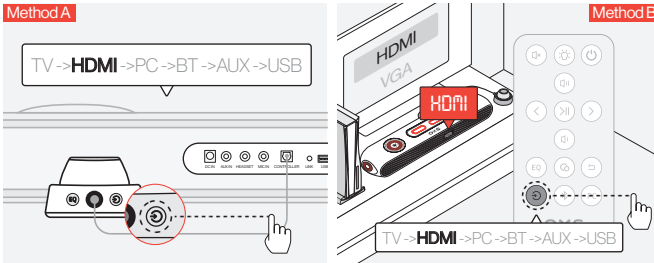

- 3 Den Audioeingang auf HDMI umschalten.

## Anschluss über das USB-C-Kabel

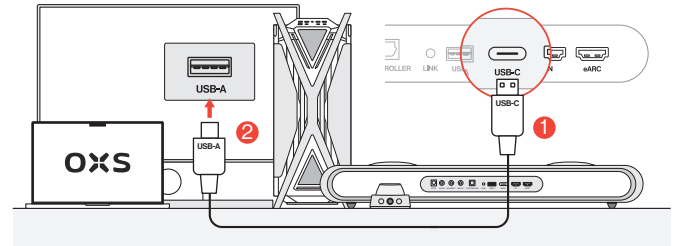

- 1 Die Soundbar mit dem mitgelieferten USB-A zu USB-C-Kabel an einen der USB-A-Anschlüsse Ihres PCs anschließen.

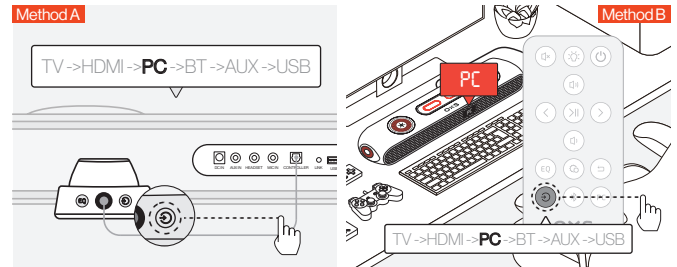

- 2 Den Audioeingang auf PC umschalten.

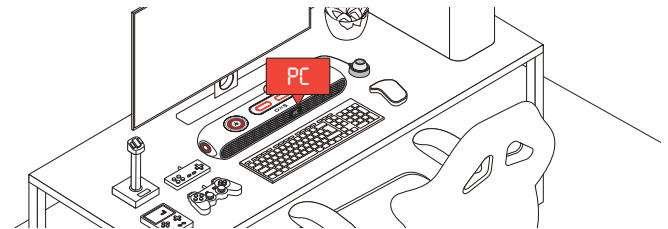

## Anschluss über das analoge Kabel

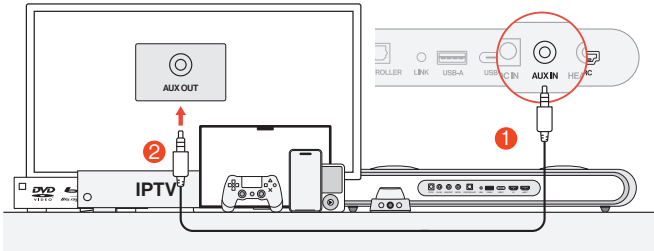

- 1 Das Gerät mit einem AUX-Kabel an die Soundbar anschließen.

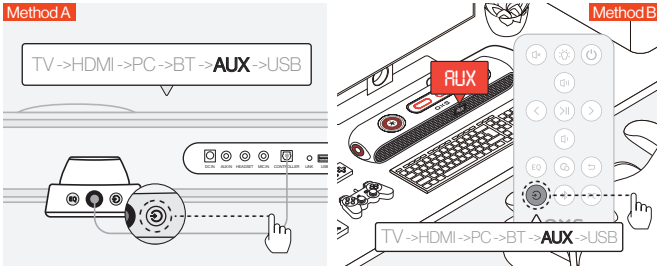

- 2 Den Audioeingang auf AUX umschalten.

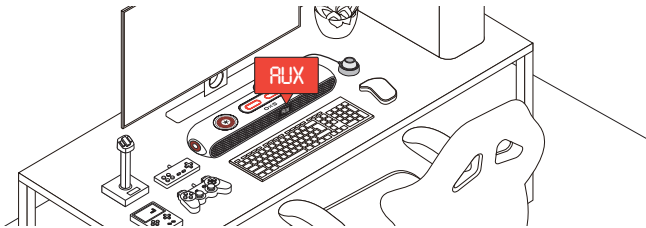

## Anschluss über Bluetooth

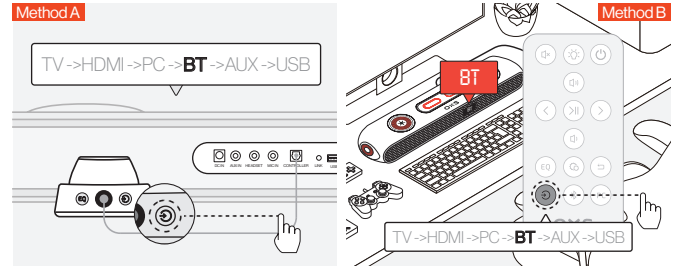

- 1 Den Audioeingang auf Bluetooth umschalten.

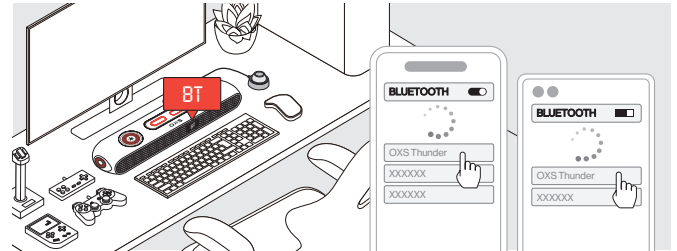

- 2 "OXS Thunder" auf dem Bildschirm des Geräts auswählen.

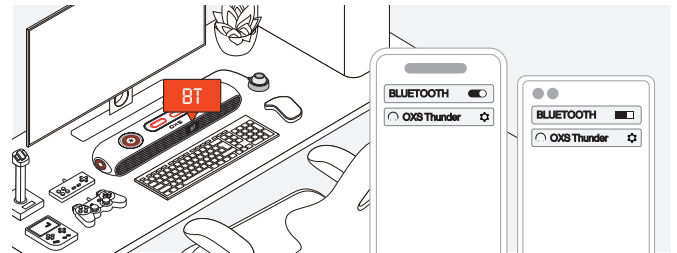

- 3 Nach dem erfolgreichen Anschluss bleibt die Anzeige „BT“ an der Soundbar stabil.

# DEN LAUTSPRECHER ALS STANDARDGERÄT EINSTELLEN

Beim ersten Gebrauch der Soundbar ist die Einstellung des Geräts als Standard-Abspielgerät des Systems notwendig.

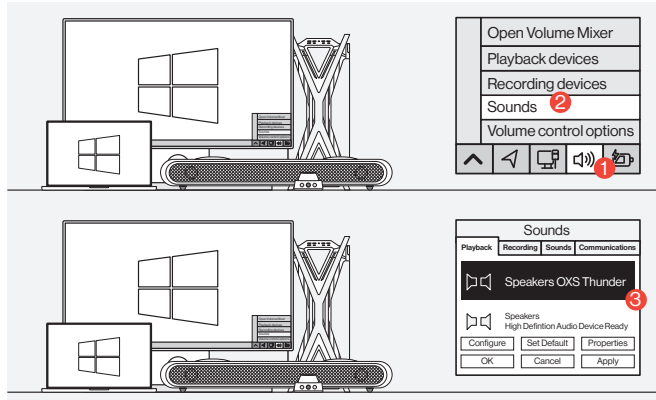

1 Für Windows-PC-Benutzer

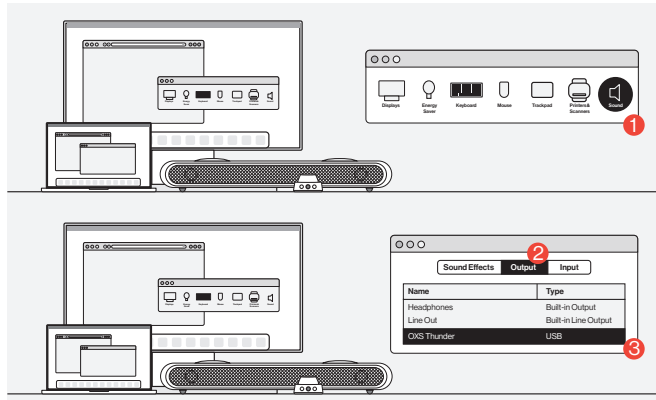

2 Für Mac-Benutzer

# AKTIVIEREN VON DOLBY ATMOS

Bitte beachten Sie, dass Dolby Atmos nur über die HDMI-Ausgabe verfügbar ist. Wenn Sie die Soundbar zum ersten Mal verwenden, müssen Sie Dolby Atmos möglicherweise auf Ihrer Spielekonsole oder Ihrem PC aktivieren. Weitere Anweisungen finden Sie auf den folgenden Websites:

[\\*https://games.dolby.com/atmos/documentation/#Platforms](https://games.dolby.com/atmos/documentation/#Platforms)



# CONTENIDO

## CONTENIDO DEL EMBALAJE

- Disposición del Dispositivo
- Remoto
- Controlador

## CONECTARSE A UNA FUENTE DE AUDIO

### CÓMO USAR

- Conexión a través de HDMI eARC/ARC
- Conexión a través de HDMI IN
- Conexión a través del cable USB-C
- Conexión a través del cable analógico
- Conexión a través de Bluetooth
- Configurar el altavoz como dispositivo predeterminado

## ACTIVAR DOLBY ATMOS

ESP - 02

ESP - 03

ESP - 05

ESP - 06

ESP - 07

ESP - 08

ESP - 08

ESP - 09

ESP - 10

ESP - 11

ESP - 12

ESP - 13

ESP - 14

# CONTENIDO DEL EMBALAJE

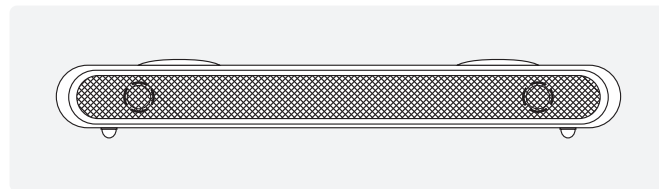

Barra de sonido OXS Thunder×1

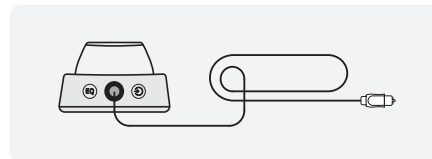

Controlador de alternancia×1



Patatas desmontables para ajuste del ángulo de la barra de sonido

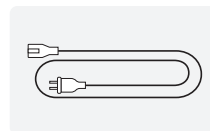

Cable de corriente×1

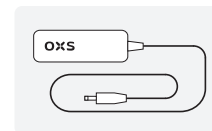

Adaptador de corriente×1

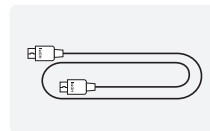

Cable HDMI×1

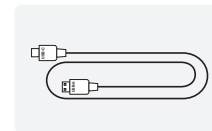

Cable USB A a C×1

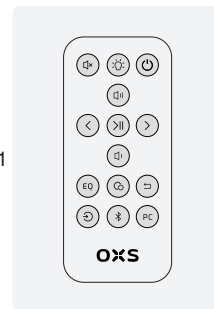

Control remoto

# DISPOSICIÓN DEL DISPOSITIVO

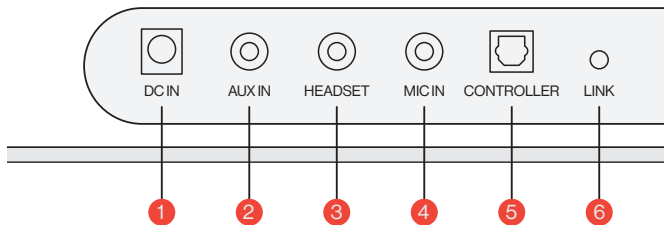
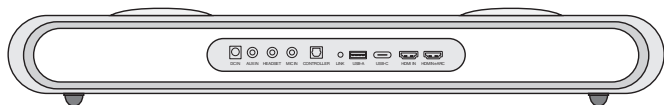

1	Fuente de alimentación		Encienda la barra de sonido usando el adaptador de corriente suministrado
2	AUX IN		Entrada de audio AUX
3	TOMA DE AURICULARES		Enchufe los auriculares a la barra de sonido para conectarse
4	TOMA DE MICRÓFONO		Conecte un micrófono externo a la barra de sonido mediante un cable estéreo de 3,5 mm
5	CONTROLADOR		Conecte el controlador de alternancia para controlar la barra de sonido
6	ENLACE		Presione para emparejar con el altavoz de cuello satelital OXS (se compra por separado)

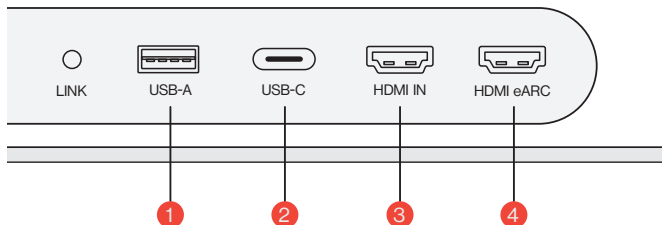
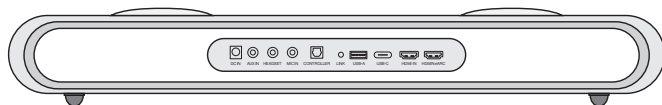

1	USB-A		Conecte el dongle para conectar el altavoz de cuello satelital OXS (se compra por separado)
2	USB-C		Conecte un cable USB (tipo C) para conectar la barra de sonido a la PC
3	HDMI IN		Conecte un cable HDMI para conectar la barra de sonido al monitor de juegos o a la PC
4	HDMI eARC		Conecte un cable HDMI para conectar la barra de sonido a la consola de juegos

# REMOTO

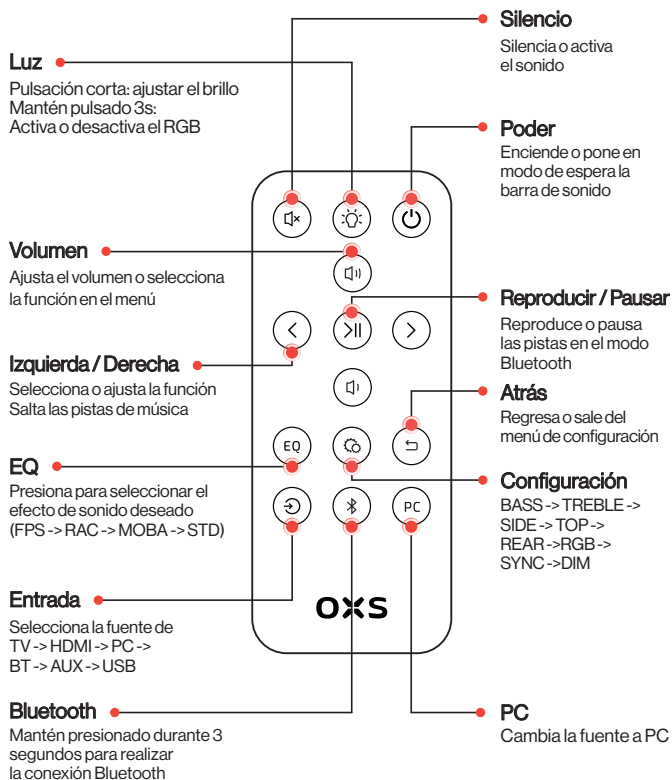

# CONTROLADOR

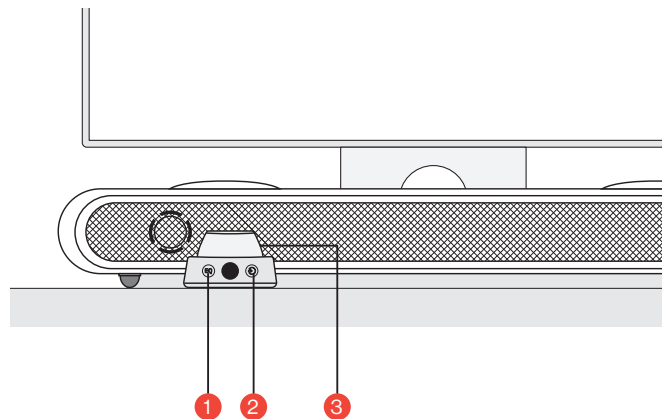

1	<b>EQ</b>		Presiona para seleccionar el efecto de sonido deseado (FPS -> RAC -> MOBA -> STD)
2	<b>Entrada</b>		Selecciona la fuente de TV -> HDMI -> PC -> BT -> AUX -> USB
3	<b>Botón principal</b>		<b>Presionar y mantener durante 3 segundos</b> Encender o poner en espera la barra de sonido
			<b>Presionar una vez</b> Silenciar la barra de sonido
			<b>Gire para ajustar el volumen</b>

# CÓMO USAR

## Configuración



## 2 Ajuste de altura

El par adicional de patas desmontables te permite cambiar la altura de la barra de sonido para asegurar que el sonido se entregue con la menor cantidad de obstrucciones. Dependiendo de la orientación de las patas, puedes configurar la barra de sonido en un ángulo plano o elevado.

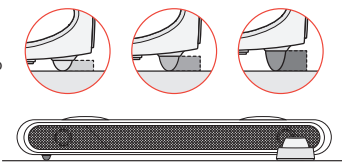

## 4 Encendido

Enciende la barra de sonido manteniendo presionado el botón.

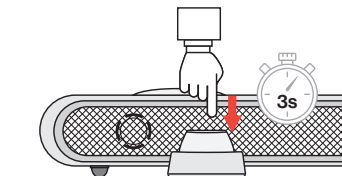

# CONECTARSE A UNA FUENTE DE AUDIO

## Conexión a través de HDMI eARC/ARC

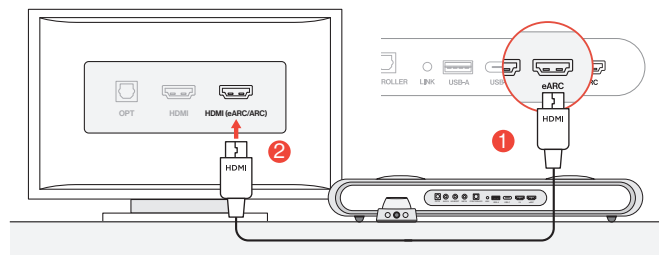

### Method A

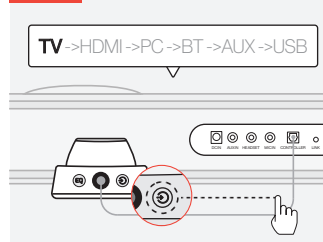

### Method B

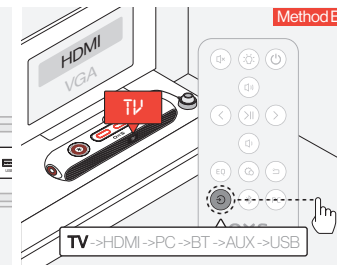

**2** Cambia la entrada de audio a "TV".

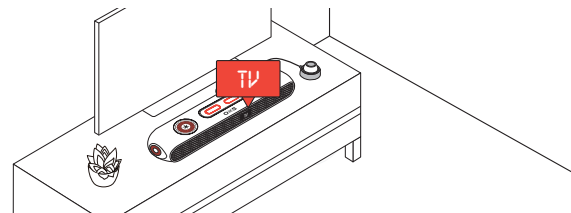

## Conexión a través de HDMI IN

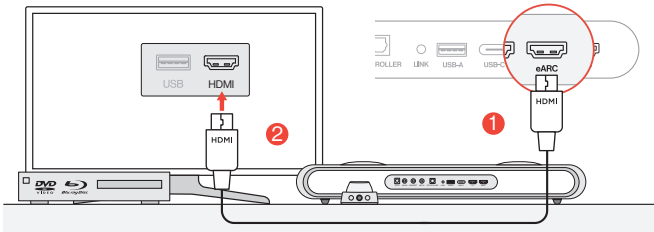

- 1 Conecta cualquiera de los puertos HDMI de tu televisor o monitor al puerto HDMI OUT de la barra de sonido.

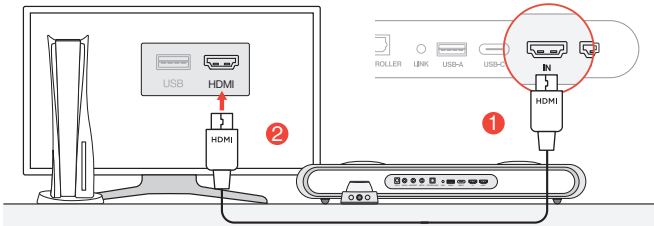

- 2 Conecta cualquiera de los puertos HDMI de tu PC o consola de juegos al puerto HDMI IN de la barra de sonido.

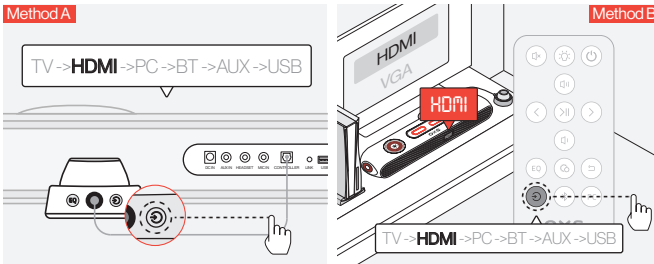

- 3 Cambia la entrada de audio a HDMI.

## Conexión a través del cable USB-C

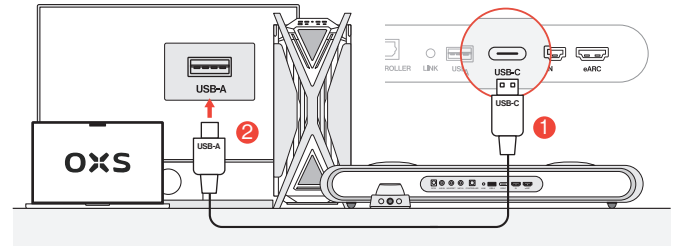

- 1 Conecta la barra de sonido a cualquiera de los puertos USB-A de tu PC utilizando el cable USB-C a USB-A incluido.

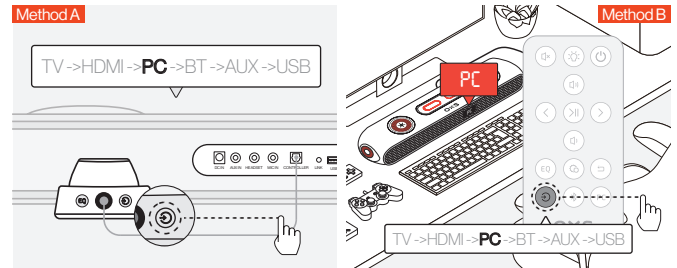

- 2 Cambia la entrada de audio al PC.

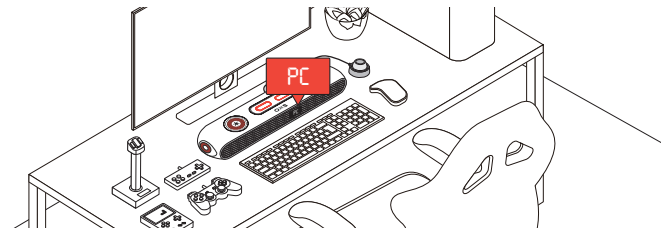

## Conexión a través del cable analógico

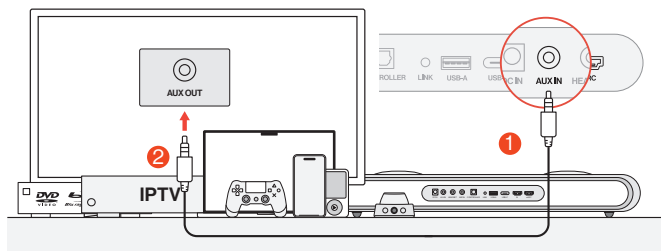

- 1 Conecta el dispositivo y la barra de sonido utilizando un cable AUX.

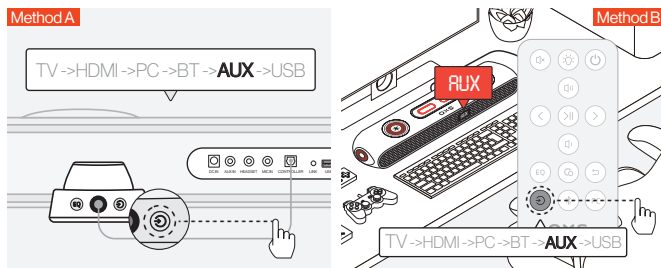

- 2 Cambia la entrada de audio a AUX.

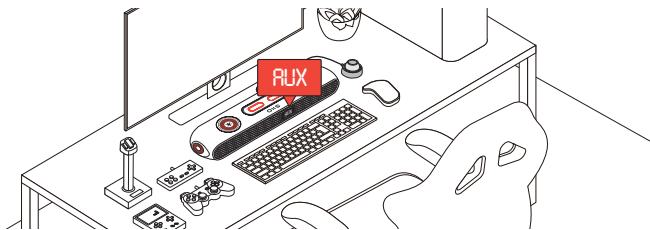

## Conexión a través de Bluetooth

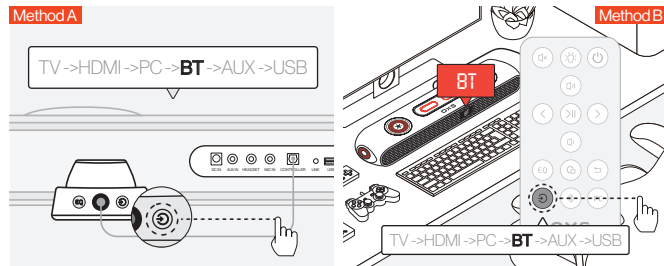

- 1 Cambia la entrada de audio a Bluetooth.

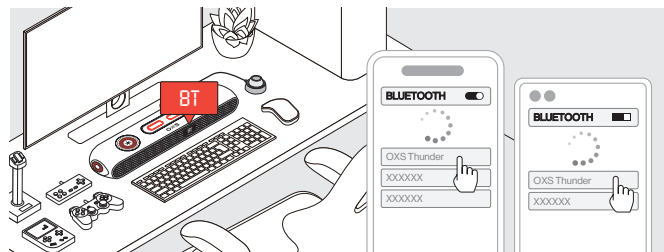

- 2 Selecciona "OXS Thunder" en la pantalla del dispositivo.

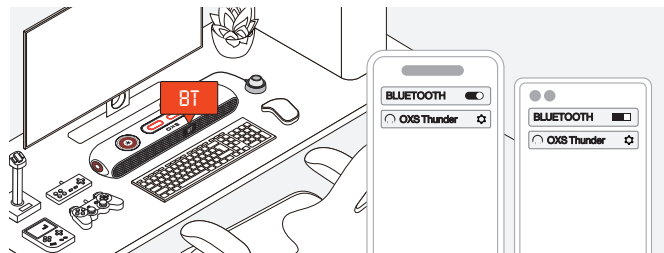

- 3 Una vez que la conexión se establezca correctamente, el indicador "BT" en la barra de sonido se mantendrá estable.

## CONFIGURAR EL ALTAVOZ COMO DISPOSITIVO PREDETERMINADO

Si estás utilizando la barra de sonido por primera vez, es posible que debas configurar el dispositivo como dispositivo de reproducción predeterminado de tu sistema.

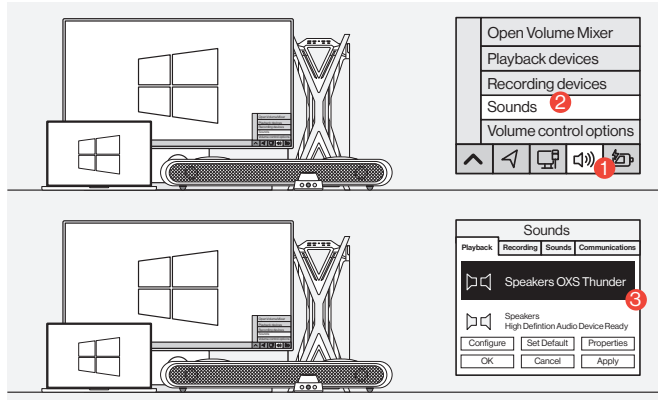

1 Para usuarios de PC con Windows

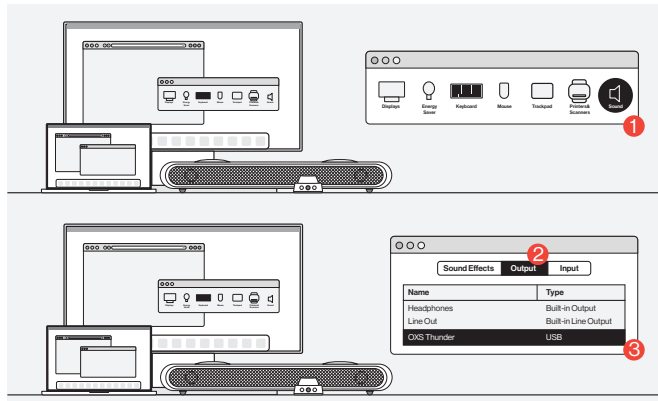

2 Para usuarios de Mac

## ACTIVAR DOLBY ATMOS

Tenga en cuenta que Dolby Atmos solo está disponible a través de la salida HDMI. Si está utilizando la barra de sonido por primera vez, es posible que deba habilitar Dolby Atmos en su consola de juegos o PC. Para obtener más instrucciones, visite los siguientes sitios web:

• <https://games.dolby.com/atmos/documentation/#Platforms>

# СОДЕРЖАНИЕ

## ЧТО ВНУТРИ

•Схема устройства

•Дистанционное

•управляющее устройство

## КАК ИСПОЛЬЗОВАТЬ

## ПОДКЛЮЧЕНИЕ К ИСТОЧНИКУ АУДИОСИГНАЛА

•Подключение через HDMI eARC/ARC

•Подключение через HDMI IN

•Подключение через кабель USB-C

•Подключение через аналоговый кабель

•Подключение через Bluetooth

•Настройка динамика как устройства по умолчанию

## ВКЛЮЧЕНИЕ DOLBY ATMOS

RU - 02

RU - 03

RU - 05

RU - 06

RU - 07

RU - 08

RU - 08

RU - 09

RU - 10

RU - 11

RU - 12

RU - 13

RU - 14

# ЧТО ВНУТРИ

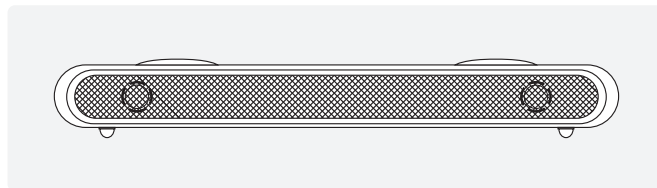

Звуковая панель OXS Thunder×1

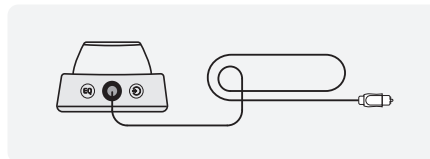

Контроллер переключения×1



Съемные ножки для регулировки угла звуковой панели

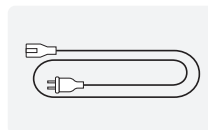

Силовой кабель×1

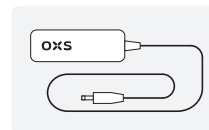

Адаптер питания×1

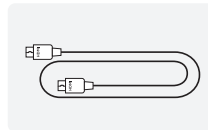

Кабель HDMI×1

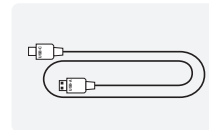

Кабель USB A к C×1



Пульт дистанционного управления



# СХЕМА УСТРОЙСТВА

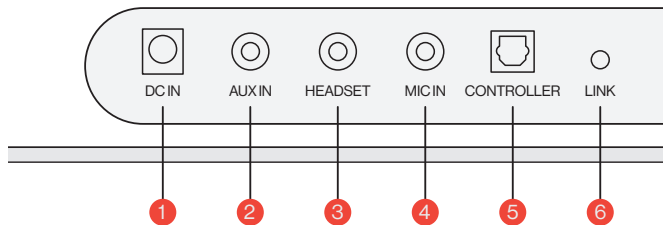
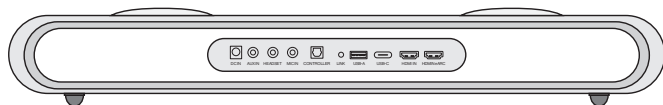

1	Питание		Включите звуковую панель, используя прилагаемый адаптер питания
2	AUX IN		Аудиовход AUX
3	РАЗЪЕМ ДЛЯ НАУШНИКОВ		Подключите кабель наушников, чтобы подключить их к звуковой панели
4	РАЗЪЕМ ДЛЯ МИКРОФОНА		Подключите внешний микрофон к звуковой панели с помощью стереокабеля 3,5 мм
5	КОНТРОЛЛЕР		Нажмите, чтобы связать спутниковый гарнитур OXS (приобретается отдельно)
6	ССЫЛКА		Presione para emparejar con el altavoz de cuello satelital OXS (se compra por separado)

RU-03

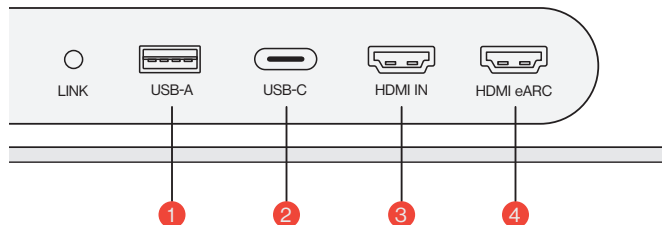
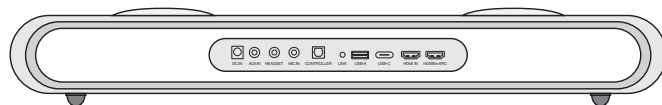

1	USB-A		Подключите докнг, чтобы подключить спутниковый гарнитур OXS (приобретается отдельно)
2	USB-C		Подключите кабель USB (тип C) чтобы подключить звуковую панель к компьютеру
3	HDMI IN		Подключите кабель HDMI, чтобы соединить звуковую панель с игровым монитором или компьютером
4	HDMI eARC		Подключите кабель HDMI, чтобы соединить звуковую панель с игровой консолью

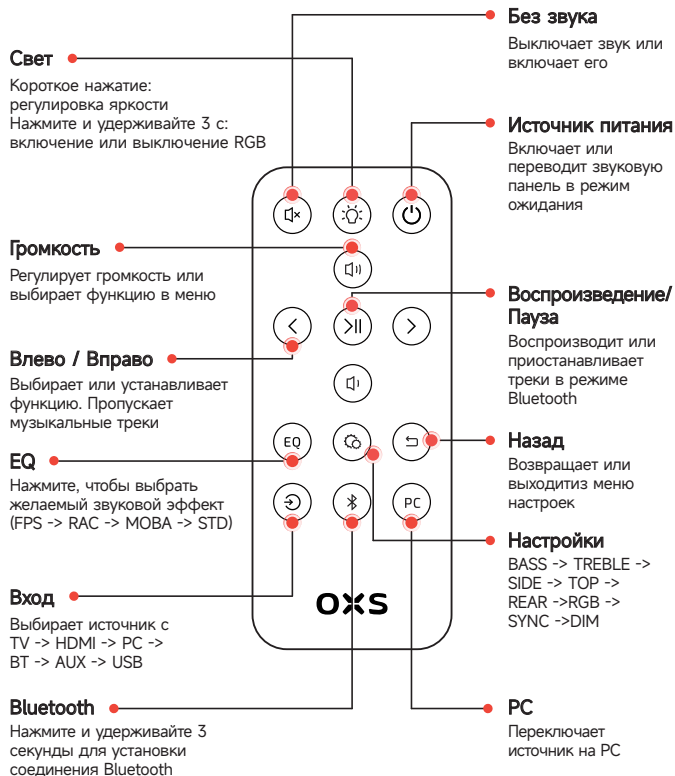

RU-04

# ДИСТАНЦИОННОЕ

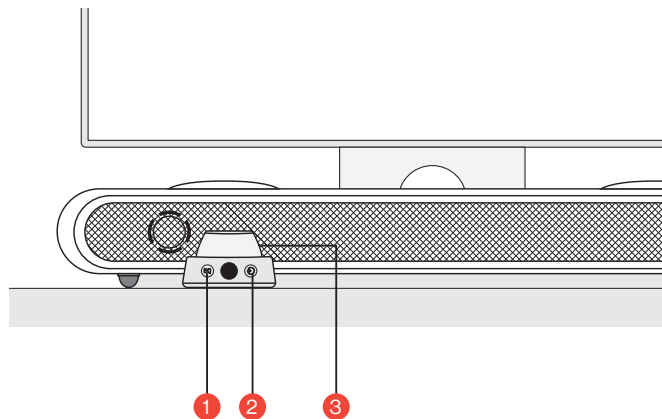

# УПРАВЛЯЮЩЕЕ УСТРОЙСТВО



1	<b>EQ (эквалайзер)</b> 	Нажмите, чтобы выбрать желаемый звуковой эффект (FPS -> RAC -> MOBA -> STD)
2	<b>Input (вход)</b> 	Выбирает источник с TV -> HDMI -> PC -> BT -> AUX -> USB
3	<b>Главная кнопка</b> 	<b>Удерживать нажатой кнопку в течение 3 секунд</b> Включить или перевести звуковую панель в режим ожидания
		<b>Однократное нажатие</b> Отключить звук на звуковой панели
		<b>Повернуть, чтобы настроить объем</b>

# КАК ИСПОЛЬЗОВАТЬ

## Настройка

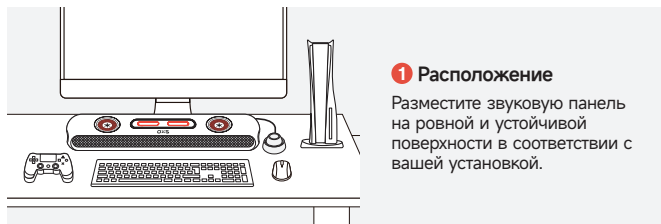

## 2 Регулировка высоты

Дополнительная пара съемных ножек позволяет вам изменить высоту звуковой панели, чтобы звук доставлялся с минимальными помехами. В зависимости от ориентации ножек, вы можете установить звуковую панель в плоском или поднятом углу.

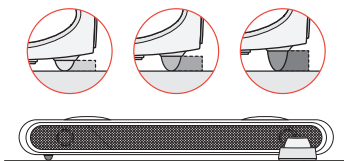

## 4 Включение питания

Включите звуковую панель, удерживая кнопку нажатой.

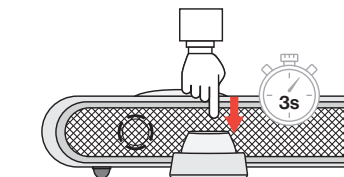

# ПОДКЛЮЧЕНИЕ К ИСТОЧНИКУ АУДИОСИГНАЛА

## Подключение через HDMI eARC/ARC

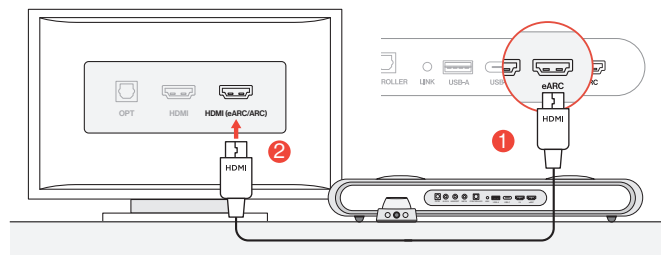

**1** Подключите звуковую панель к любому из портов HDMI (eARC/ARC) на вашем телевизоре, используя прилагаемый HDMI-кабель.

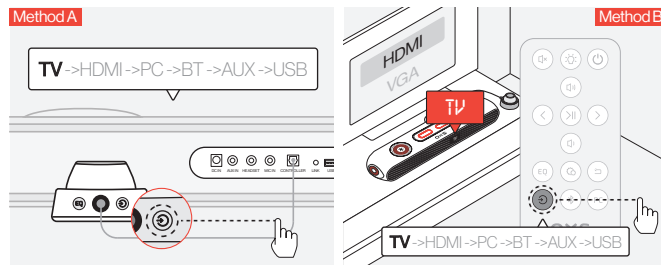

**2** Переключите аудиовход на "TV" (ТВ).

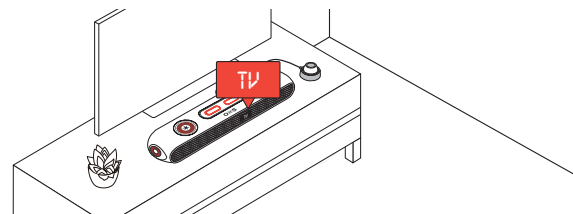

## Подключение через HDMI IN

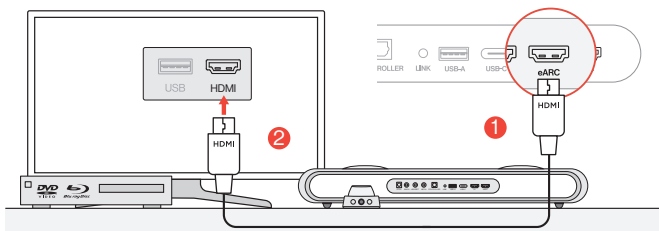

- 1 Подключите любой из HDMI-портов вашего телевизора или монитора к порту HDMI OUT звуковой панели.

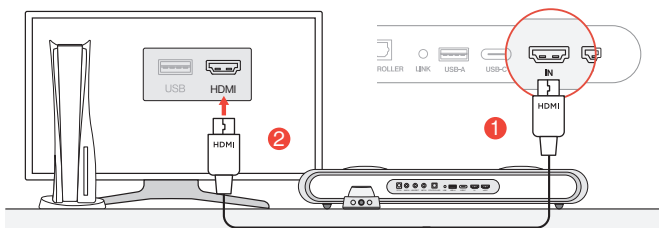

- 2 Подключите любой из HDMI-портов вашего компьютера или игровой приставки к порту HDMI IN звуковой панели.

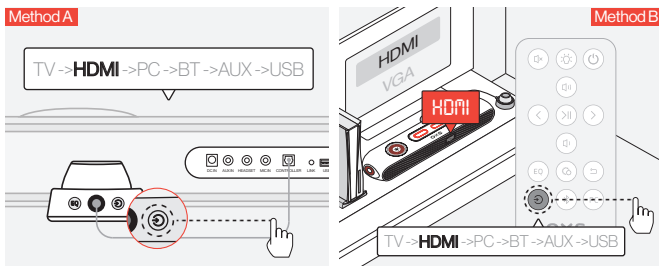

- 3 Переключите аудиовход на HDMI.

## Подключение через кабель USB-C

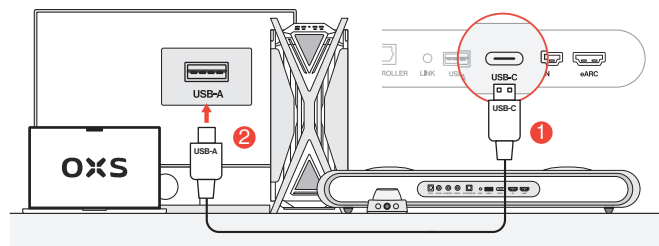

- 1 Подключите звуковую панель к любому из USB-A портов вашего компьютера с помощью прилагаемого кабеля USB-C to USB-A.

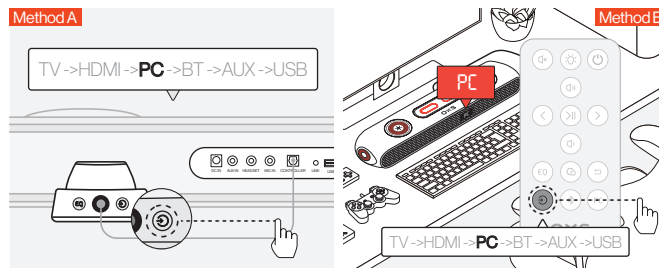

- 2 Переключите аудиовход на компьютер.

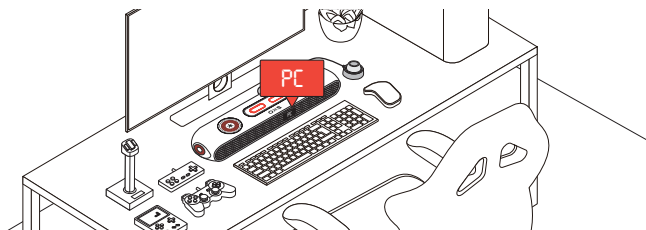

## Подключение через аналоговый кабель

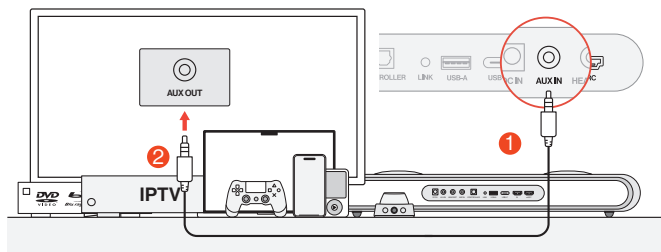

- 1 Подключите устройство и звуковую панель с помощью аудио-кабеля AUX.

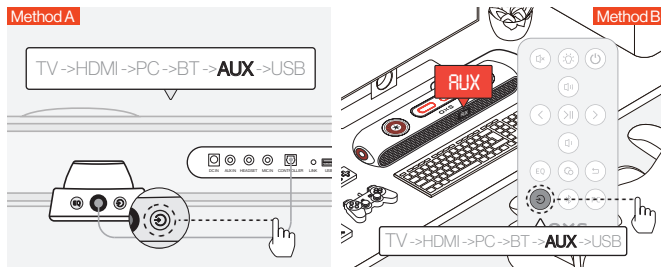

- 2 Переключите аудиовход на AUX.

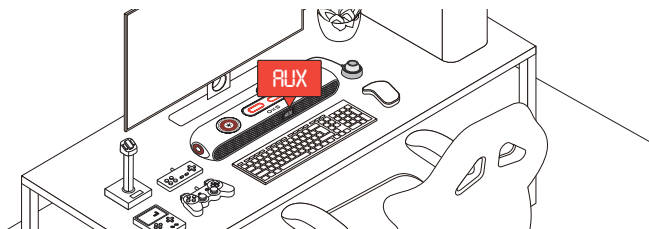

## Подключение через Bluetooth

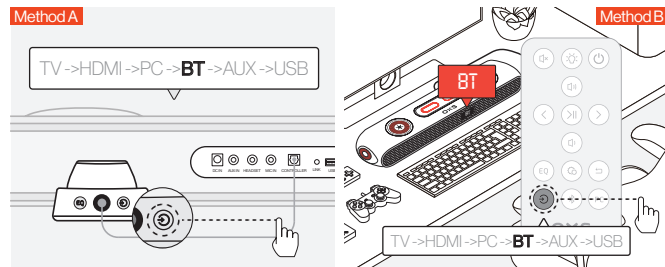

- 1 Переключите аудиовход на Bluetooth.

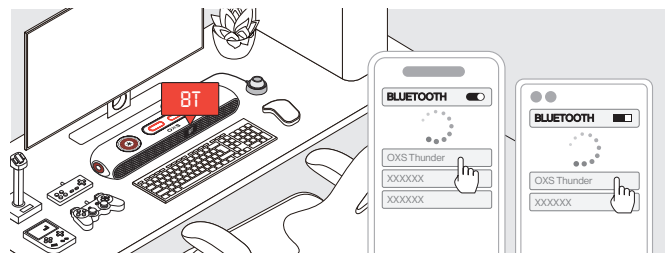

- 2 Выберите "OXS Thunder" на экране устройства.

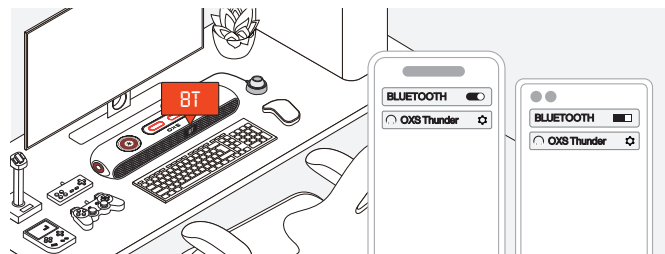

- 3 После успешного подключения индикатор "BT" на звуковой панели будет гореть постоянно.

## НАСТРОЙКА ДИНАМИКА КАК УСТРОЙСТВА ПО УМОЛЧАНИЮ

Если вы используете звуковую панель впервые, вам может потребоваться настроить устройство как основное устройство воспроизведения для вашей системы.

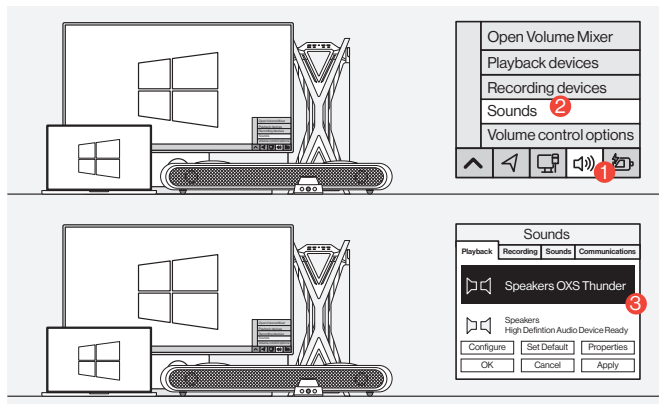

1 Для пользователей ПК с Windows

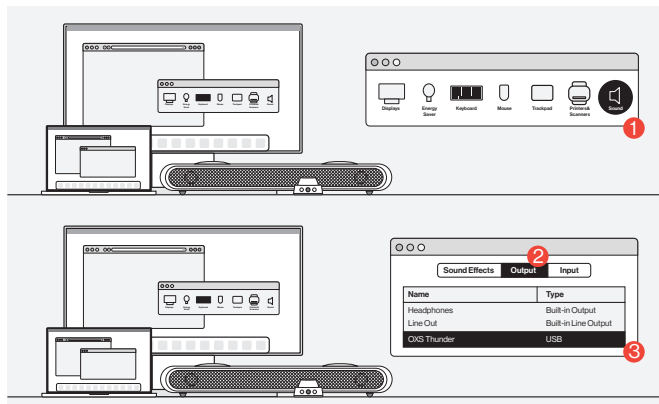

2 Для пользователей Mac

## ВКЛЮЧЕНИЕ DOLBY ATMOS

Обратите внимание, что Dolby Atmos доступен только через выход HDMI. Если вы используете звуковую панель впервые, вам может потребоваться включить Dolby Atmos на вашей игровой приставке или ПК. Дополнительные инструкции можно найти на следующих веб-сайтах:

• <https://games.dolby.com/atmos/documentation/#Platforms>

## 目录

### 包装内含

- 设备布局
- 遥控
- 线控

### 操作指南

### 连接音频源

- 通过HDMI eARC/ARC连接
- 通过HDMI IN连接
- 通过USB-C电缆连接
- 通过模拟电缆连接
- 通过蓝牙连接
- 将音箱设置为默认设备

### 启用杜比全景声

zhCN - 02

zhCN - 03

zhCN - 05

zhCN - 06

zhCN - 07

zhCN - 08

zhCN - 08

zhCN - 09

zhCN - 10

zhCN - 11

zhCN - 12

zhCN - 13

zhCN - 14

## 包装内含

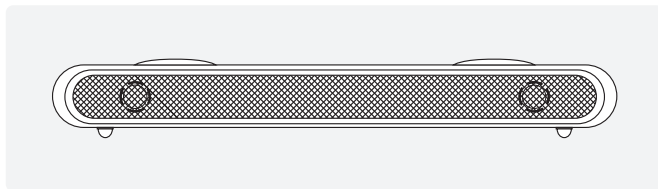

OXS Thunder 游戏音箱×1

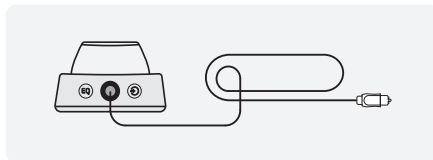

有线控制器×1



可拆卸的脚垫  
用于调整音箱角度

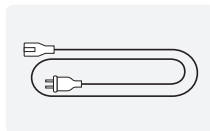

电源电缆×1

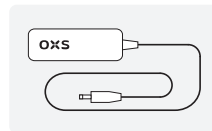

电源适配器×1

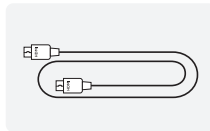

HDMI 线×1

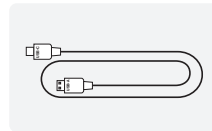

USB A 转 C 线×1

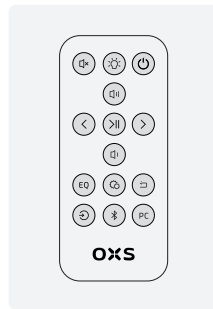



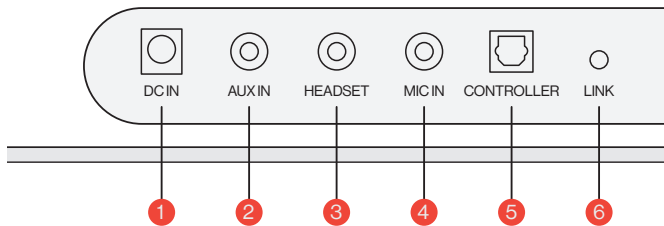
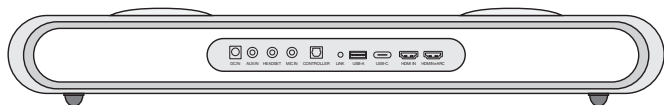

遥控器

## 设备布局

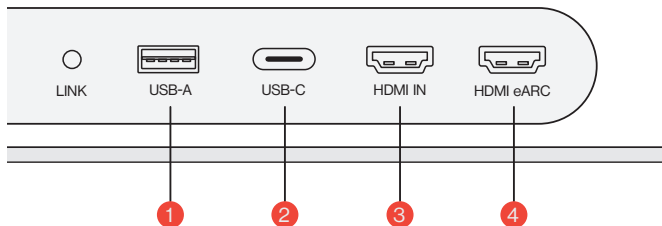
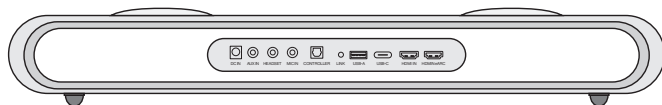

1	电源		使用提供的电源适配器为音响供电
2	AUX 输入		AUX 音频输入
3	耳机插孔		将耳机插入音箱进行连接
4	麦克风插孔		通过3.5毫米立体声电缆将外部麦克风连接到音箱
5	有线控制器		插入有线控制器以控制音箱
6	连接		按下以与OXS卫星颈部扬声器配对(单独购买)



1	USB-A		插入适配器将OXS卫星颈部扬声器连接(单独购买)
2	USB-C		插入USB (C型) 线将音箱连接到电脑
3	HDMI 输入		插入HDMI线将音箱连接到显示器或电脑
4	HDMI eARC		插入HDMI线将音箱连接到游戏主机



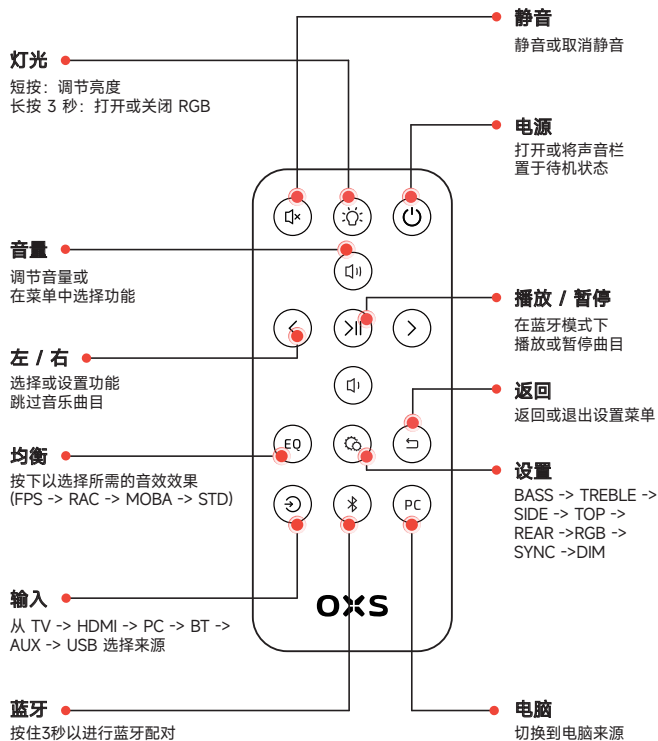

## 遥控

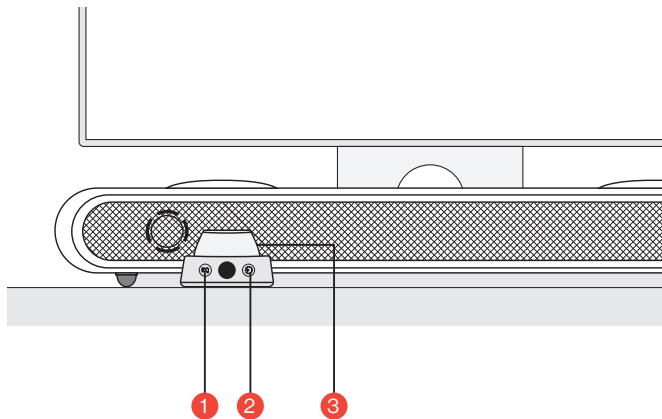

## 线控



1	<b>EQ (均衡器)</b> 	按下以选择所需的音效效果 (FPS -> RAC -> MOBA -> STD)
2	<b>输入</b> 	从 TV -> HDMI -> PC -> BT -> AUX -> USB 选择来源
3	<b>主按钮</b> 	<b>长按3秒钟</b> 开启或将音箱置于待机状态
		<b>短按</b> 将音箱静音
		<b>旋转调节音量</b>

# 操作指南

## 设置



### 2 调整高度

额外的可拆卸脚架可以让您调整音箱的高度，以确保声音传递时最少受到阻碍。根据脚架的方向，您可以将音响栏设置为平放或提高角度。

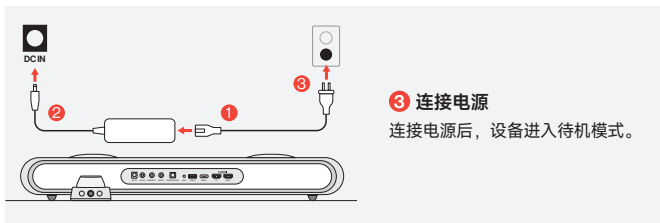
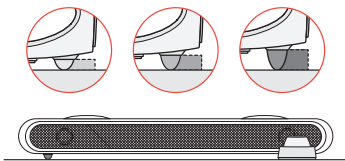

### 4 开机

通过长按按钮开启音箱。

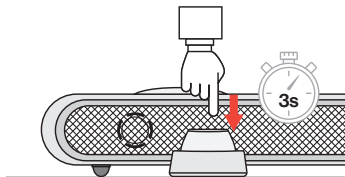

# 连接音频源

## 通过HDMI eARC/ARC连接

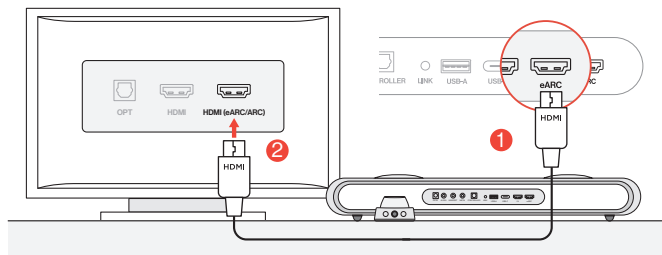

**1** 使用附带的HDMI线将音箱连接到电视上的任意一个HDMI (eARC/ARC)端口。

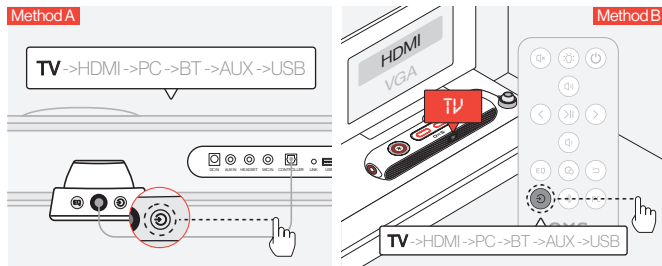

**2** 将音频输入切换到“TV” (电视)。

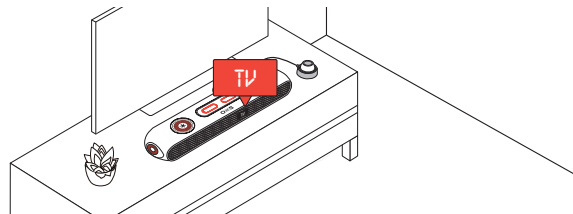

## 通过HDMI IN连接

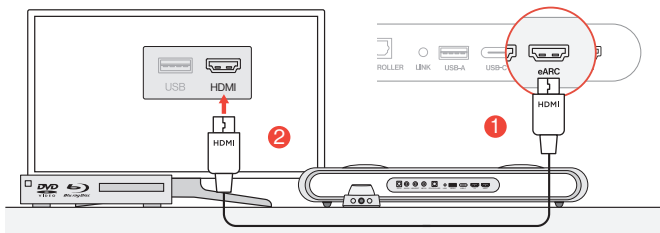

- 1 将电视或显示器上的任意HDMI端口连接到音箱的HDMI OUT端口。

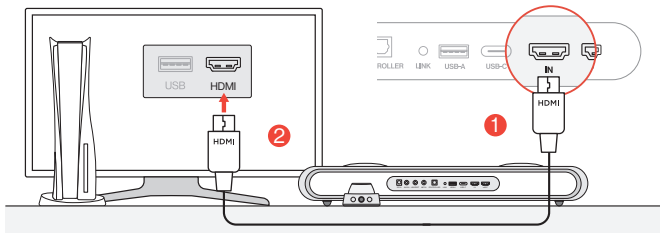

- 2 将个人电脑或游戏主机上的任意HDMI端口连接到音箱的HDMI IN端口。

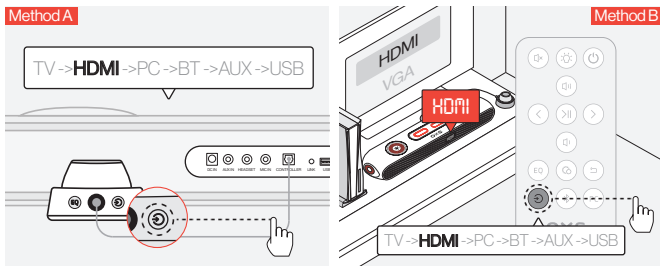

- 3 将音频输入切换到HDMI。

zhCN-09

## 通过USB-C电缆连接

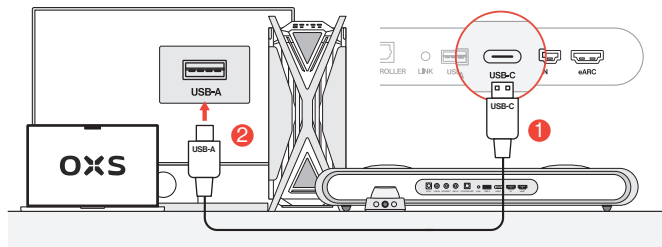

- 1 使用附带的USB-C至USB-A电缆，将音箱连接到您的个人电脑上的任意USB-A端口。

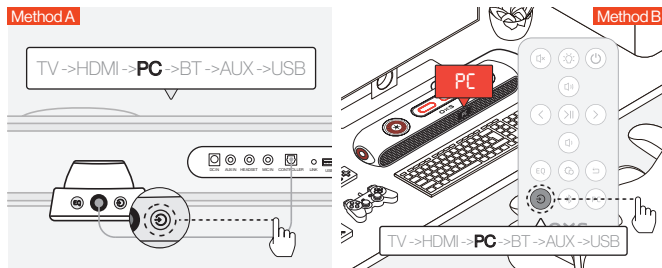

- 2 将音频输入切换到个人电脑。

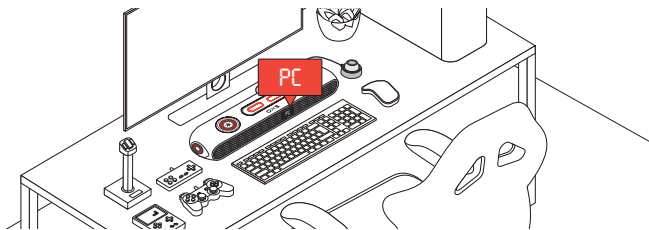

zhCN-10

## 通过模拟电缆连接

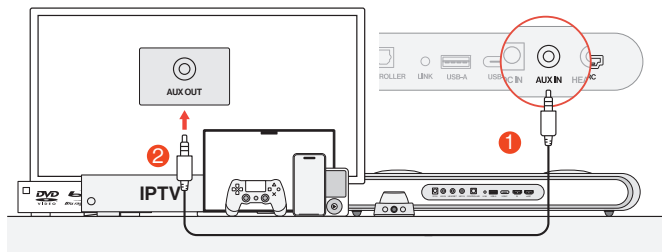

- 1 使用AUX电缆将设备和音箱连接起来。

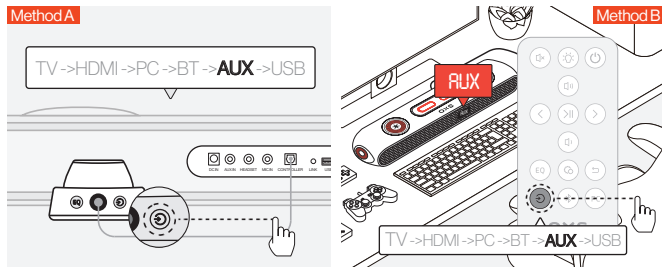

- 2 将音频输入切换到AUX。

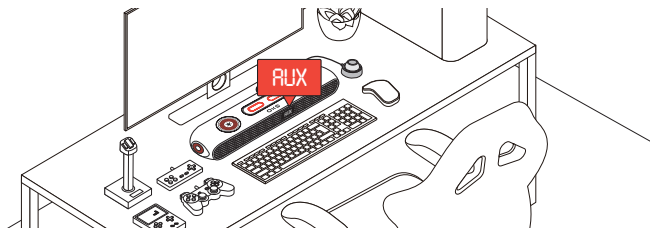

## 通过蓝牙连接

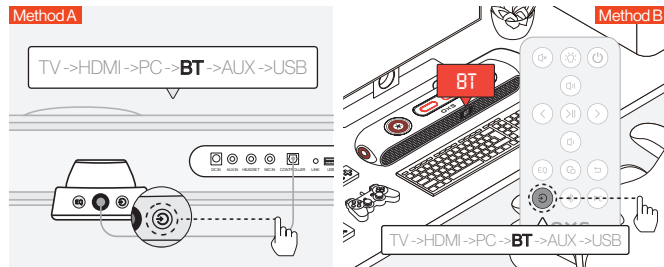

- 1 将音频输入切换到蓝牙。

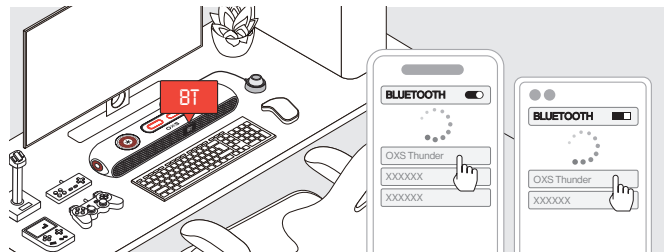

- 2 在设备屏幕上选择“OXS Thunder”。

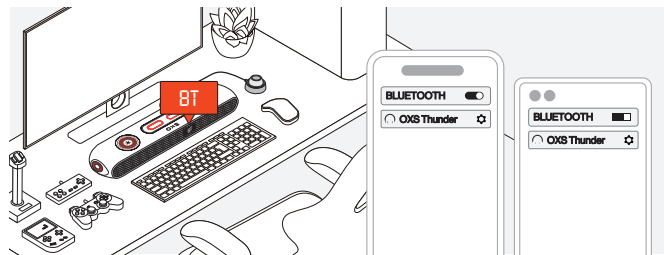

- 3 成功连接后，音箱上的“BT”指示灯将保持稳定。

## 将音箱设置为默认设备

如果您是第一次使用该音箱，可能需要将其设置为系统的默认播放设备。

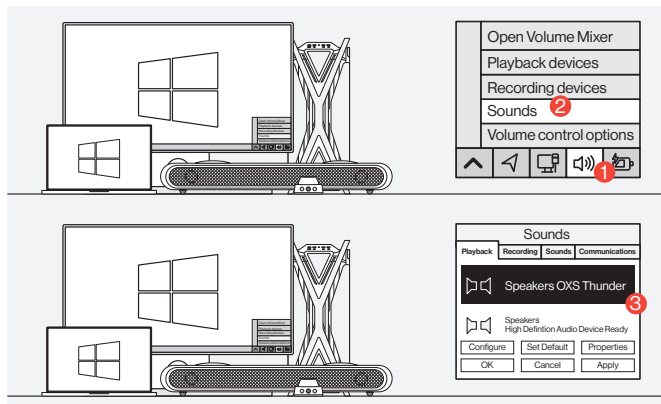

**1** 对于Windows PC用户

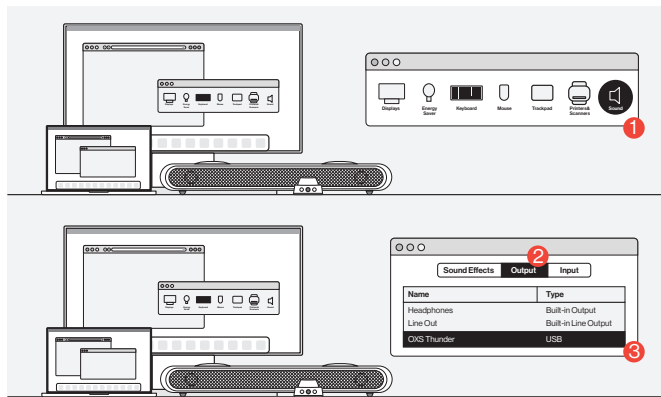

**2** 对于MAC用户

## 启用杜比全景声

请注意，杜比全景声只能通过HDMI输出使用。如果您是第一次使用该音箱，可能需要在游戏机或电脑上启用杜比全景声。更多相关说明，请访问以下网站：

[\\*https://games.dolby.com/atmos/documentation/#Platforms](https://games.dolby.com/atmos/documentation/#Platforms)

## 目錄

### 包裝內含

- 設備佈局
- 遙控
- 線控

### 操作指南

### 連接音頻源

- 通過HDMI eARC/ARC連接
- 通過HDMI IN連接
- 通過USB-C電纜連接
- 通過模擬電纜連接
- 通過藍牙連接
- 將音箱設置為預設裝置

### 啟用杜比全景聲

twCN - 02

twCN - 03

twCN - 05

twCN - 06

twCN - 07

twCN - 08

twCN - 08

twCN - 09

twCN - 10

twCN - 11

twCN - 12

twCN - 13

twCN - 14

## 包裝內含

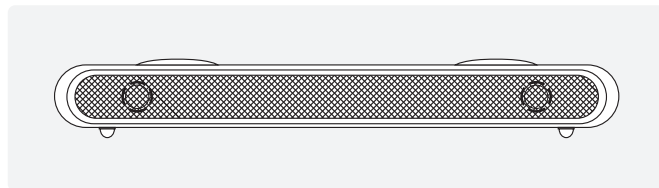

OXS Thunder 遊戲音箱×1

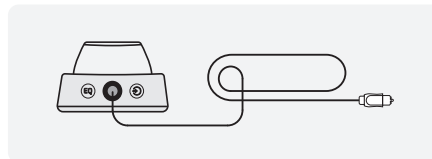

有線控制器×1



可拆卸的腳墊  
用於調整音箱角度

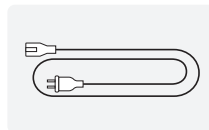

電源電纜×1

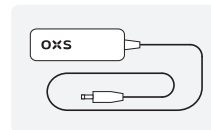

電源適配器×1

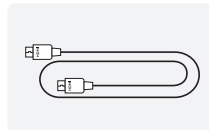

HDMI 線×1

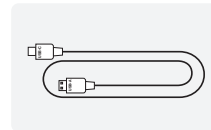

USB A 轉 C 線×1

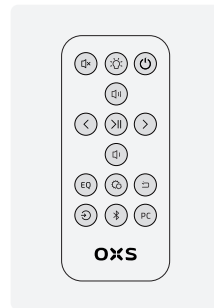



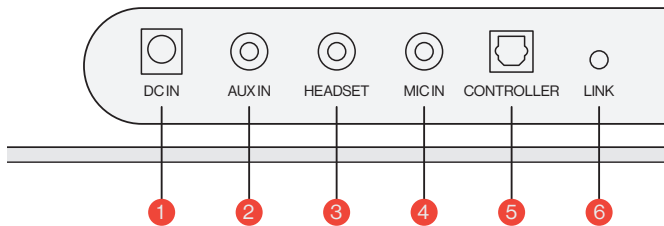
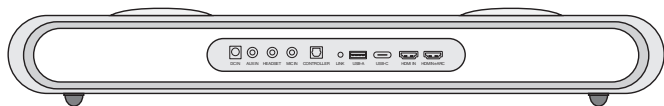

遙控器

## 設備佈局

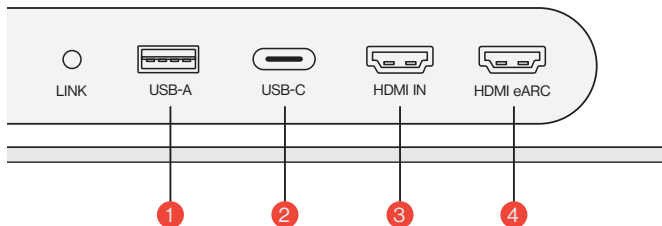
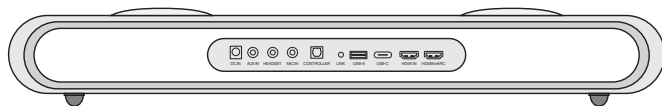

1	電源		使用提供的電源適配器為音箱供電
2	AUX 輸入		AUX 音頻輸入
3	耳機插孔		將耳機插入音箱進行連接
4	麥克風插孔		通過3.5毫米立體聲電纜將外部麥克風連接到音箱
5	有線控制器		插入有線控制器以控制音箱
6	連接		按下以與OXS衛星頸部揚聲器配對(單獨購買)



1	USB-A		插入適配器將OXS衛星頸部揚聲器連接(單獨購買)
2	USB-C		插入USB (C型) 線將音箱連接到電腦
3	HDMI 輸入		插入HDMI線將音箱連接到遊戲監視器或電腦
4	HDMI eARC		插入HDMI線將音響連接到遊戲主機

## 遙控

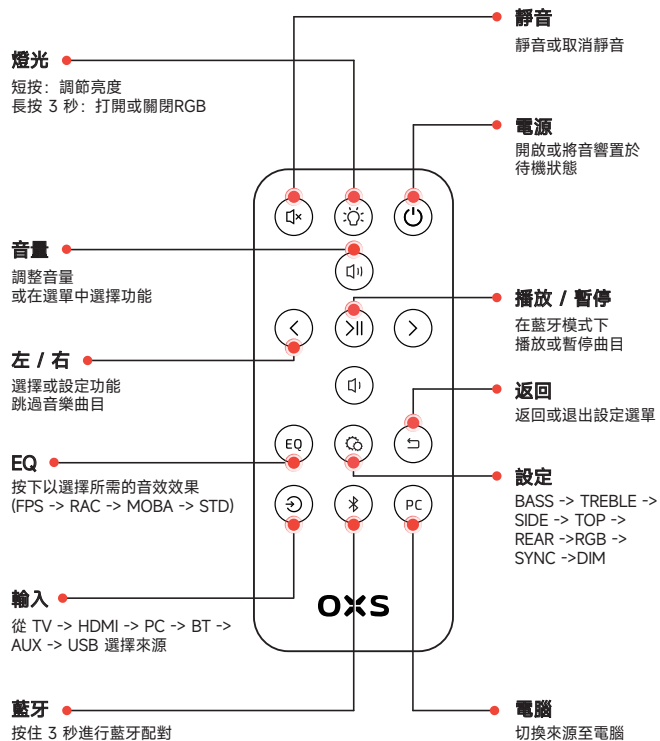

## 線控

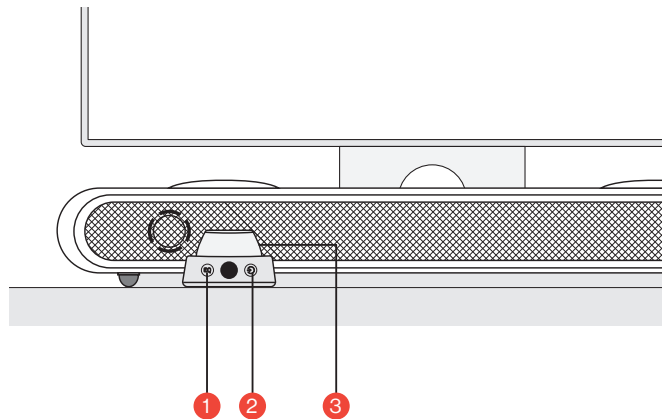

1	<b>EQ (均衡器)</b>		按下以選擇所需的音效效果 (FPS -> RAC -> MOBA -> STD)
2	<b>輸入</b>		從 TV -> HDMI -> PC -> BT -> AUX -> USB 選擇來源
3	<b>主按鈕</b>		<b>長按3秒鐘</b> 開啟或將音響置於待機狀態
			<b>短按</b> 將音響靜音
			旋轉調節音量



# 操作指南

## 設置



### 2 調整高度

額外的可拆卸腳架可讓您調整音箱的高度，以確保聲音傳遞時的阻礙最少。根據腳架的方向，您可以將音箱設置為平放或提高角度。

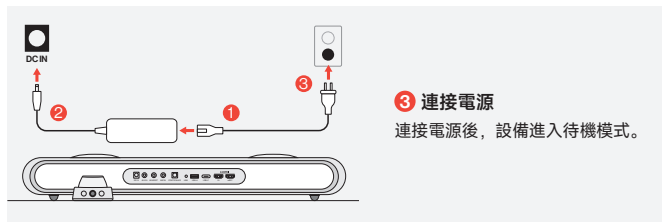
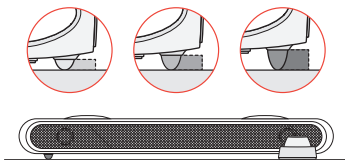

### 4 開機

通過長按按鈕開啟音箱。

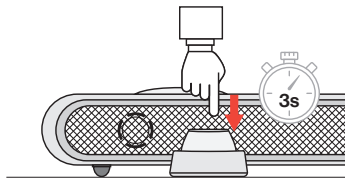

# 連接音頻源

## 通過HDMI eARC/ARC連接

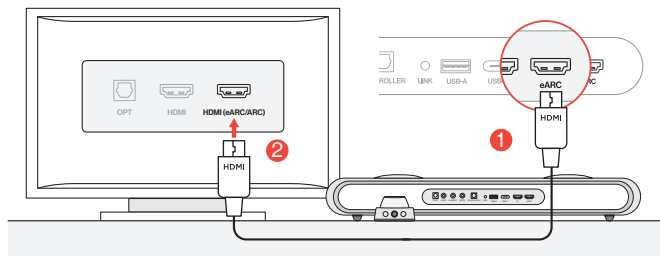

1 使用附帶的HDMI線將音響連接到電視上的任意一個HDMI (eARC/ARC)端口。

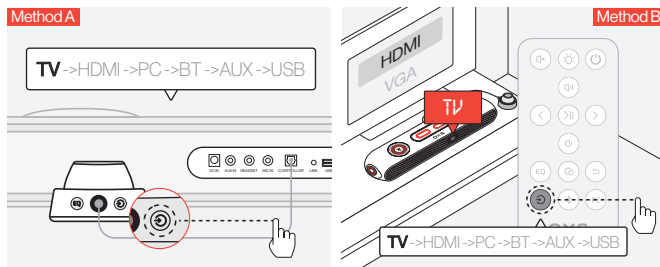

2 將音頻輸入切換到"TV" (電視)。

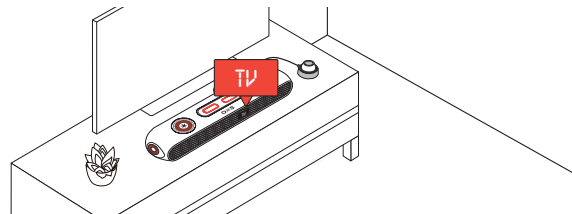

## 透過HDMI IN連接

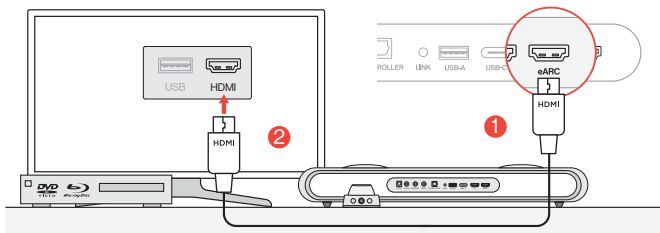

- 1 將電視或顯示器上的任一HDMI端口連接到音箱的HDMI OUT端口。

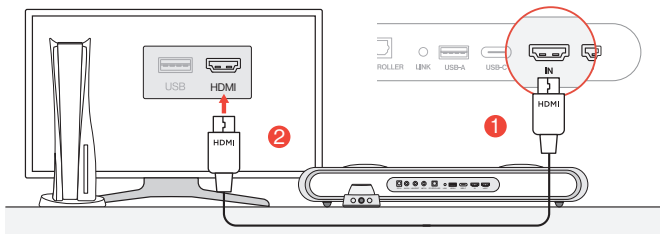

- 2 將個人電腦或遊戲主機上的任一HDMI端口連接到音箱的HDMI IN端口。

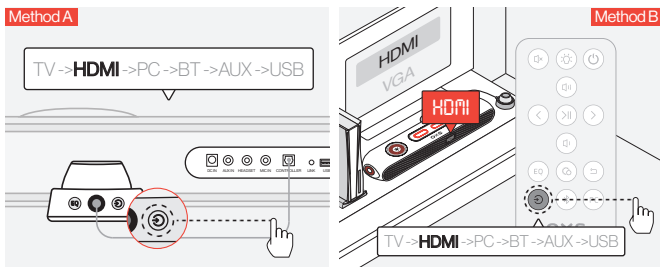

- 3 將音頻輸入切換到HDMI。

## 透過USB-C電纜連接

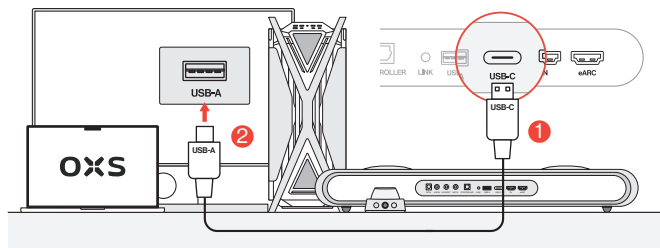

- 1 使用附帶的USB-C至USB-A電纜，將音箱連接到您的個人電腦上的任一USB-A端口。

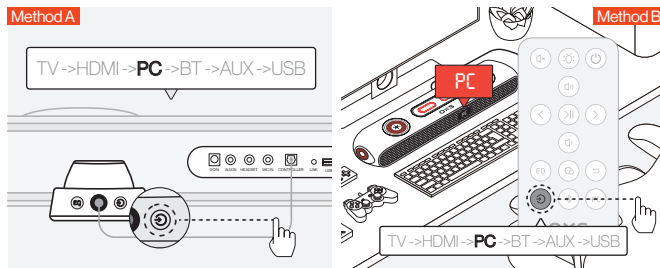

- 2 將音頻輸入切換到個人電腦。

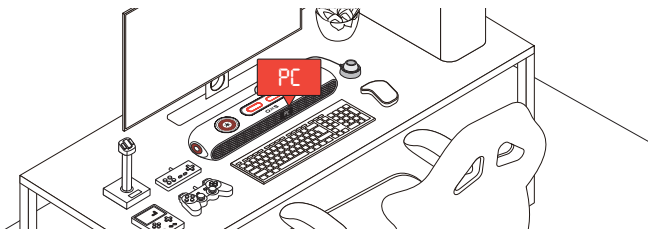

## 透過模擬電纜連接

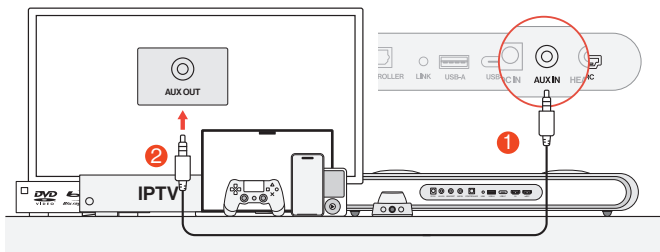

- 1 使用AUX電纜將設備和音箱連接起來。

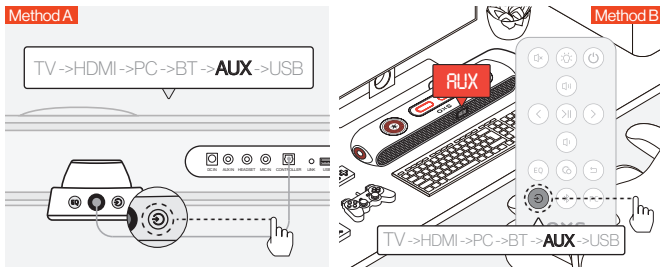

- 2 將音頻輸入切換到AUX。

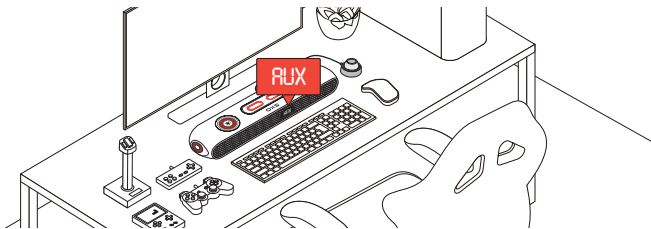

## 通過藍牙連接

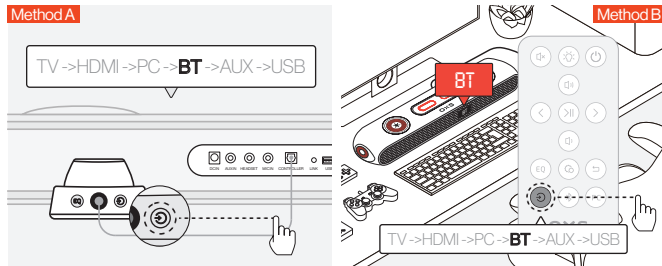

- 1 將音頻輸入切換到藍牙。

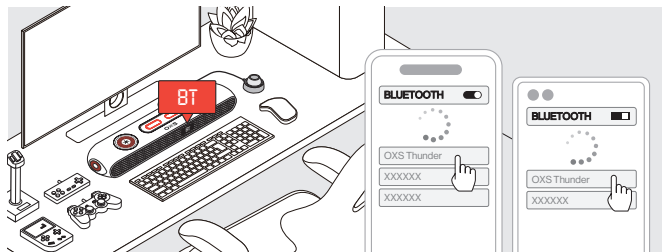

- 2 在設備螢幕上選擇「OXS Thunder」。

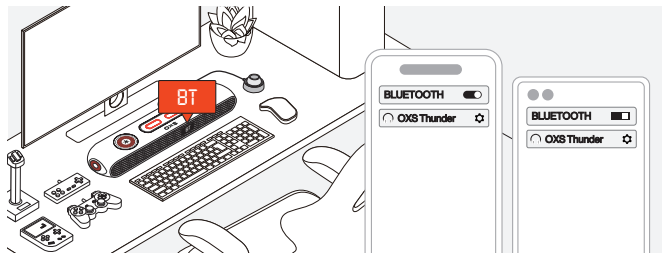

- 3 連接成功後，音箱上的「BT」指示燈將保持穩定。

## 將音箱設置為預設裝置

如果您是第一次使用該音箱，可能需要將其設置為系統的默認播放設備。

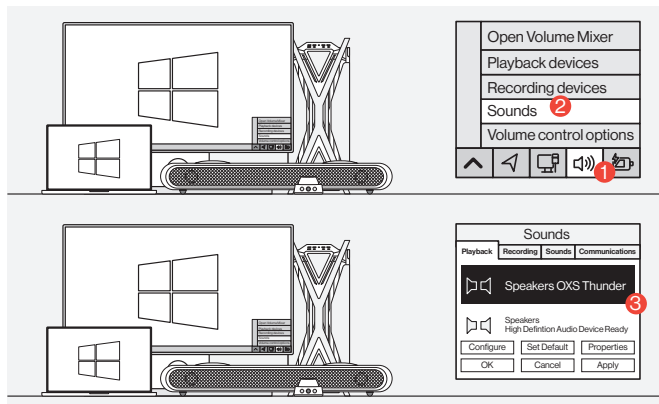

**1** 對於Windows PC用戶

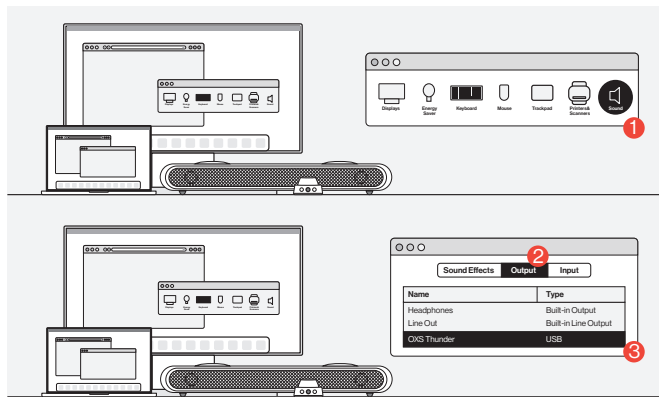

**2** 對於Mac用戶

## 啟用杜比全景聲

請注意，杜比全景聲只能通過HDMI輸出使用。如果您是第一次使用該音箱，可能需要在遊戲機或電腦上啟用杜比全景聲。更多相關說明，請訪問以下網站：

• <https://games.dolby.com/atmos/documentation/#Platforms>

## 目録

### セット内容

- 各部のなまえとはたらき
- リモコン
- トグルコントローラー

### 操作方法

#### オーディオ入力に接続

- HDMI eARC/ARCで接続
- HDMI INで接続する
- USB-Cケーブルで接続する
- アナログケーブルで接続する
- Bluetoothで接続する
- スピーカーをデフォルトデバイスに設定する

#### DOLBY ATMOSを有効にする

JP - 02

JP - 03

JP - 05

JP - 06

JP - 07

JP - 08

JP - 08

JP - 09

JP - 10

JP - 11

JP - 12

JP - 13

JP - 14

## セット内容

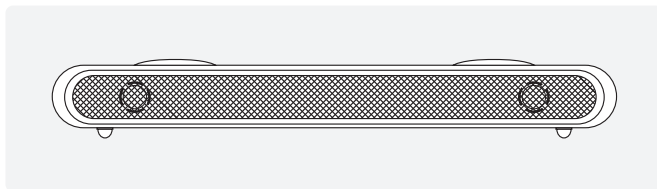

OXS Thunder サウンドバー×1

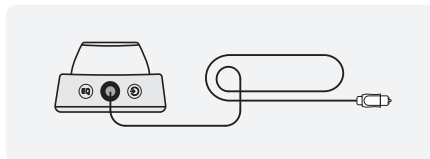

トグルコントローラー×1



サウンドバーの角度調整用の取り外し可能スタンド

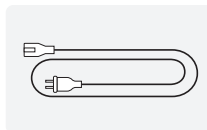

電源ケーブル×1

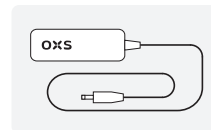

電源アダプター×1

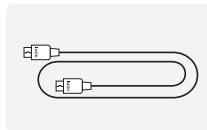

HDMIケーブル×1

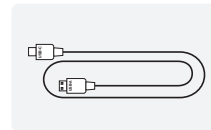



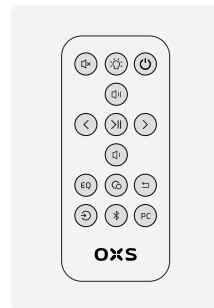



USB A to Cケーブル×1

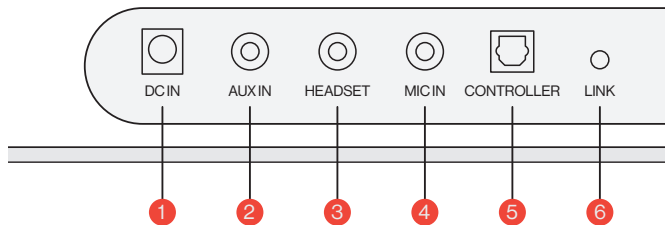
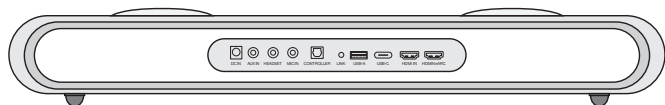





リモコン

## 各部のなまえとはたらき

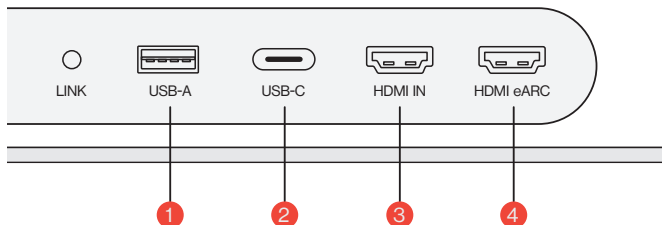
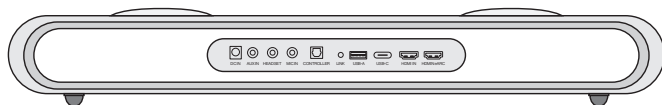

1	電源入力		付属の電源アダプターで本機に電源を入力する
2	AUX入力		AUXオーディオを入力する
3	ヘッドホンジャック		ヘッドホンやイヤホンを差し込んで本機に接続する
4	マイクジャック		3.5mmステレオケーブルで外付けマイクを本機に接続する
5	コントローラー		トグルコントローラーを差し込んで本機に接続する
6	ペアリング		ここを押してOXSサテライトネックスピーカー（別売）とペアリングする



1	USB-A		アダプターを差し込んでOXSサテライトネックスピーカー（別売）を接続する
2	USB-C		USB-Cケーブルを使ってサウンドバーをパソコンに接続する
3	HDMI入力		HDMIケーブルでサウンドバーをゲームモニターやパソコンに接続する
4	HDMI eARC		HDMIケーブルでサウンドバーをコンソールに接続する

# リモコン

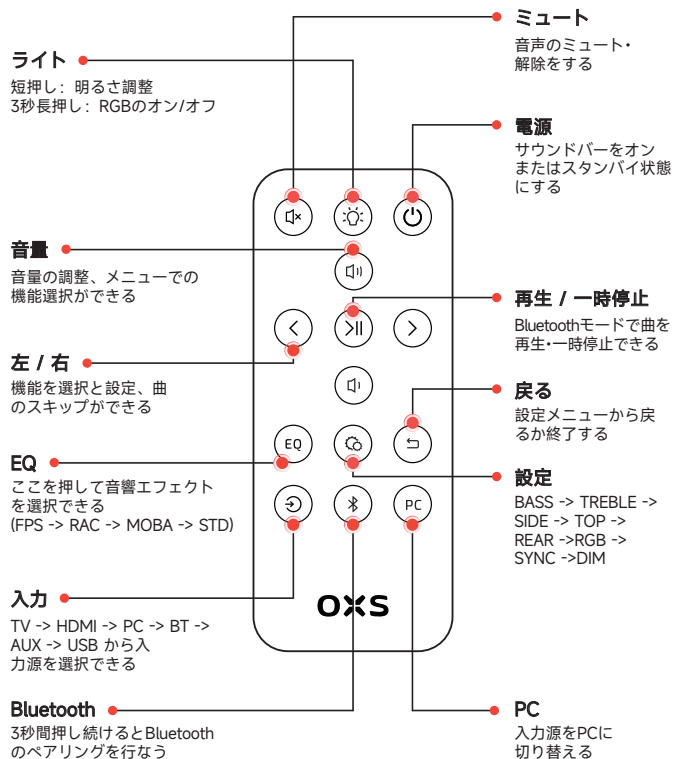

# トグルコントローラー

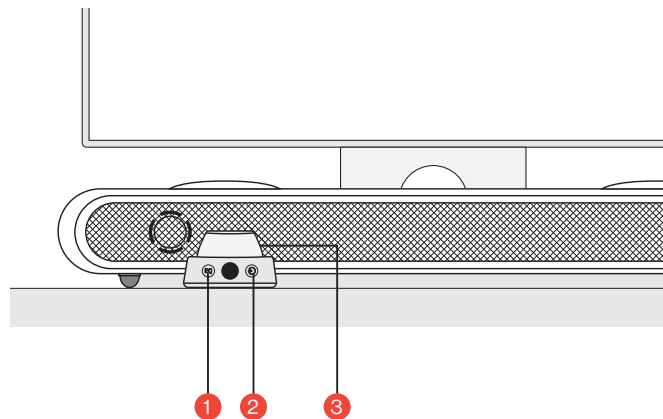

1	EQ		ここを押して音響エフェクトを選択できる (FPS -> RAC -> MOBA -> STD)
2	入力		TV -> HDMI -> PC -> BT -> AUX -> USB から入力源を選択できる
3	メインボタン		3秒間押し続けると サウンドバーをオンまたはスタンバイ状態にする
			1回押し 音声をミュートにする
			回転して音量を調整します

# 操作方法

## 設定



### 2 高さ調整

音声転送への障害を最小限に抑えるために、取り外し可能なスタンドを使ってサウンドバーの高さを調整できる。スタンドを変えることでサウンドバーの設置角度を調整できる。

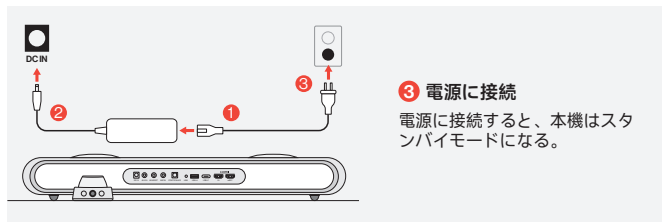
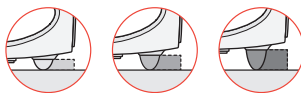

### 4 パワーオン

このボタンを短押しして本機をオンにする。

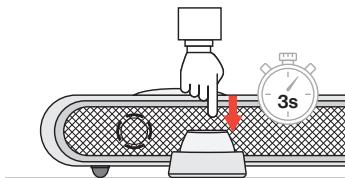

# オーディオ入力に接続

## HDMI eARC/ARCで接続

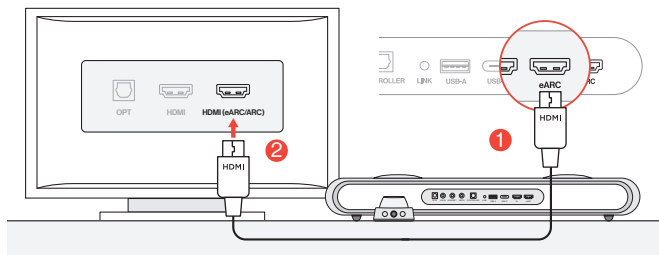

1 同梱のHDMIケーブルを使ってサウンドバーをテレビの任意のHDMI (eARC/ARC)ポートに接続する。

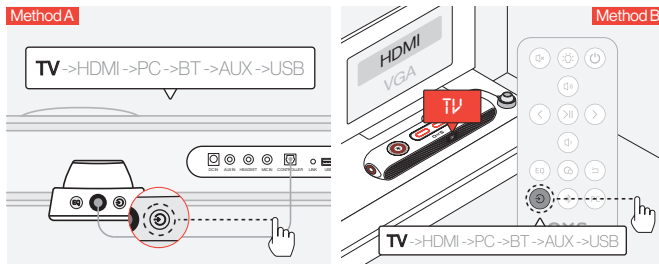

2 オーディオ入力を「TV」に切り替える。

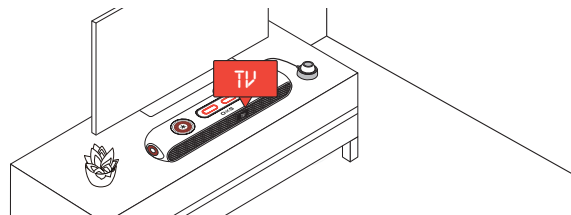



## HDMI INで接続する

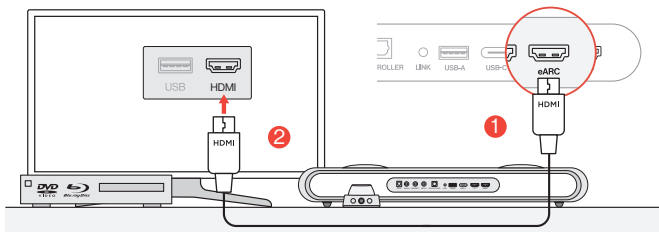

- 1 テレビまたはモニターのHDMIポートのいずれかを、サウンドバーのHDMI OUTポートに接続する。

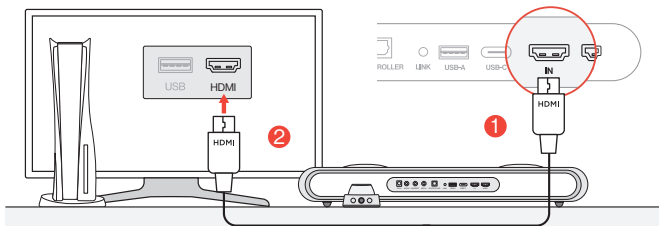

- 2 パソコンまたはゲームコンソールのHDMIポートのいずれかを、サウンドバーのHDMI INポートに接続する。

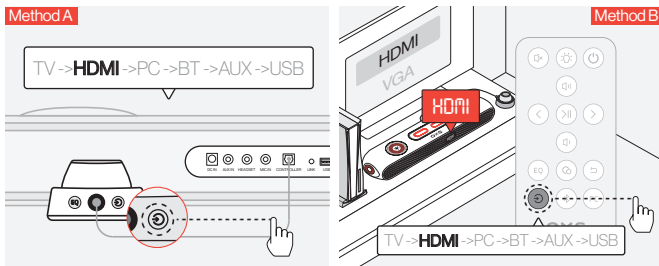

- 3 オーディオ入力をHDMIに切り替える。

## USB-Cケーブルで接続する

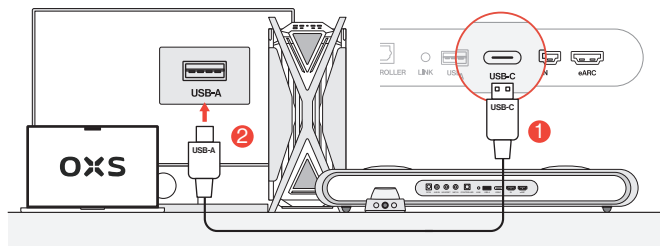

- 1 付属のUSB-C to Aケーブルを使ってサウンドバーをパソコンの任意のUSB-Aポートに接続する。

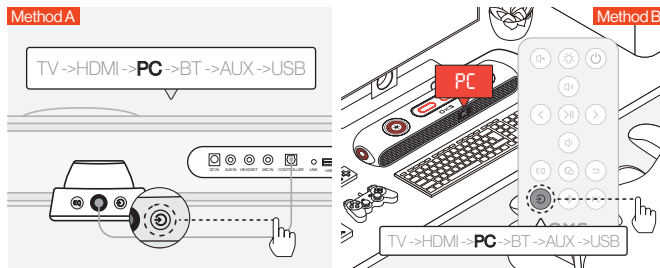

- 2 オーディオ入力をパソコンに切り替える。

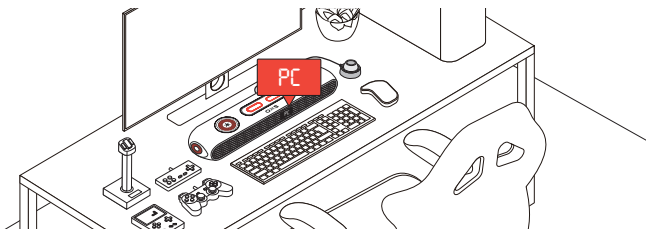

## アナログケーブルで接続する

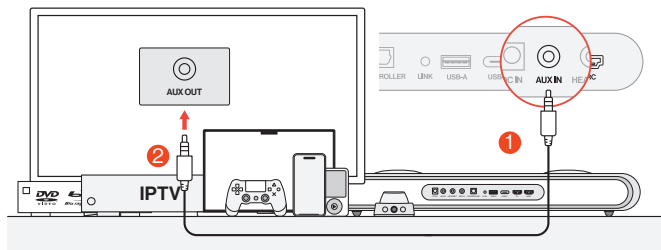

- 1 デバイスとサウンドバーをAUXケーブルで接続する。

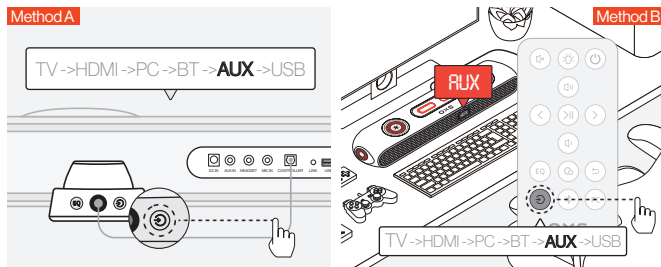

- 2 オーディオ入力をAUXに切り替える。

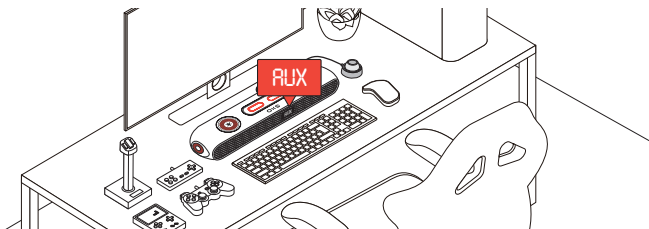

## Bluetoothで接続する

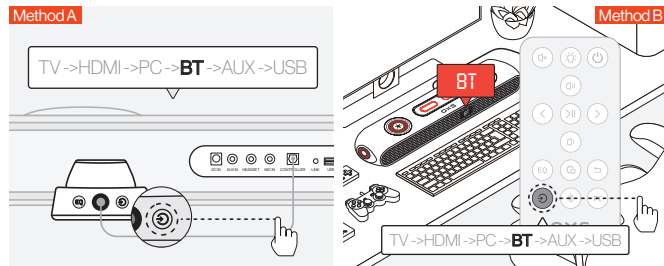

- 1 オーディオ入力をBluetoothに切り替える。

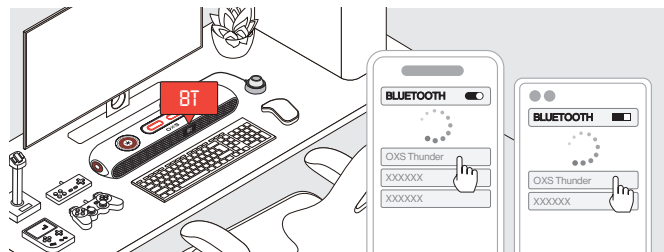

- 2 デバイスリストで「OXS Thunder」を選択する。

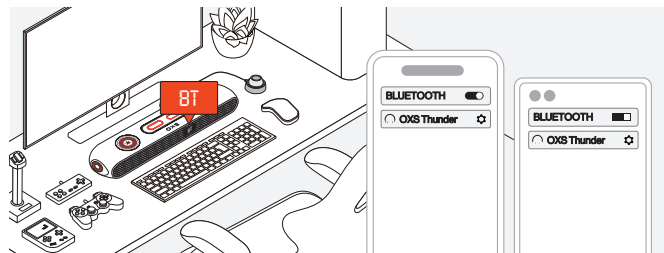

- 3 接続が成功したら、サウンドバーの「BT」インジケータが安定した状態になる。

## でスピーカーをデフォルトデバイスに設定する

サウンドバーを初めてご利用になる場合、本機をシステムのデフォルト再生デバイスとして設定する必要があります。

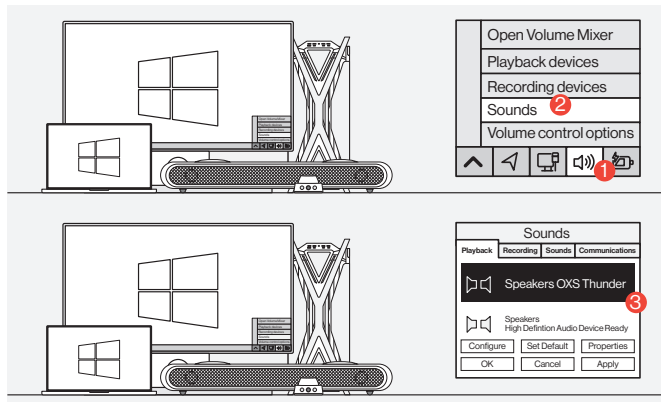

① Windows PCユーザー向け

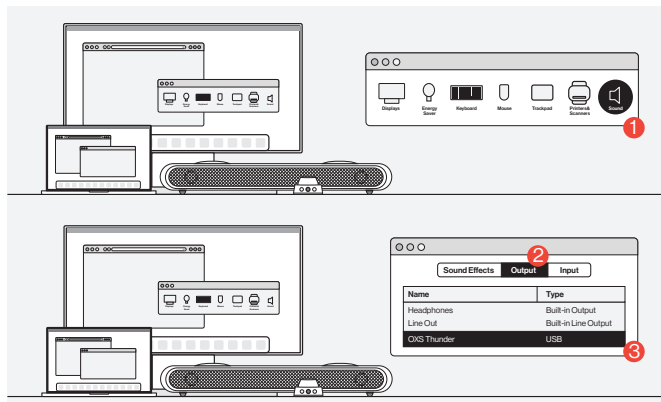

② Macユーザー向け

## DOLBY ATMOS を有効にする

Dolby Atmos は HDMI 出力でのみ利用可能です。音響バーを初めて使用する場合、ゲームコンソールやPCで Dolby Atmos を有効にする必要があります。詳しい手順については、以下のサイトをご覧ください:

• <https://games.dolby.com/atmos/documentation/#Platforms>

# 목차

## 패킹 리스트

- 디바이스 레이아웃
- 원격
- 컨트롤러

## 사용 방법

### 음원에 연결해 주십시오

- HDMI eARC/ARC 연결
- HDMI IN을 통한 연결
- USB-C 케이블을 통한 연결
- 아날로그 케이블로 연결
- 블루투스로 연결하기
- 스피커를 기본 장치로 설정하기

## DOLBY ATMOS 활성화

KR-02

KR-03

KR-05

KR-06

KR-07

KR-08

KR-08

KR-09

KR-10

KR-11

KR-12

KR-13

KR-14

# 패킹 리스트

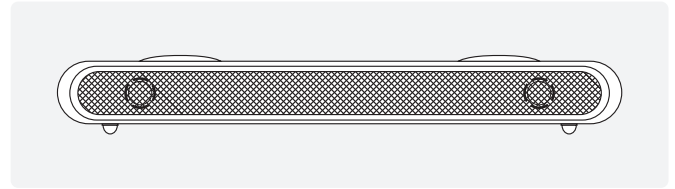

OXS Thunder 게임 스피커×1

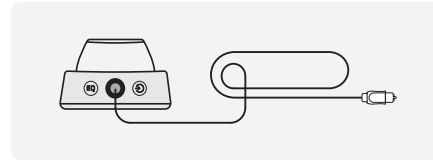

유선 컨트롤러×1



스피커 각도 조절을 위한 분리 가능한 발판

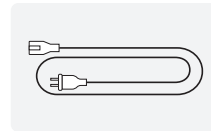

전원 케이블×1

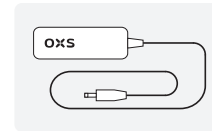

전원 어댑터×1

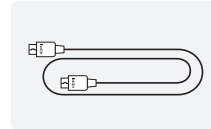

HDMI 케이블×1

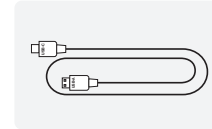

USB A에서 C로 변환하는 케이블×1

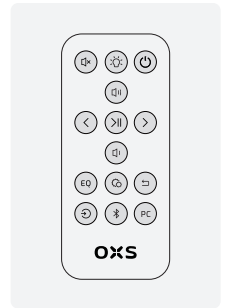

원격

## 디바이스 레이아웃

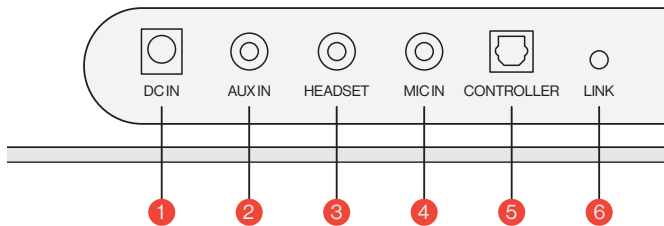
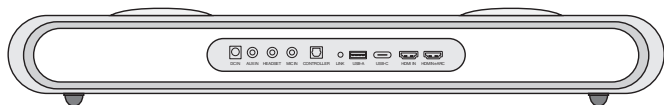

1	전원 공급		공급된 전원 어댑터를 사용하여 사운드바를 켭니다
2	AUX 입력		AUX 오디오 입력입니다
3	헤드셋 잭		헤드셋이나 이어폰을 연결하기 위해 사운드바 잭에 꽂습니다
4	마이크 잭		외부 마이크를 3.5mm 스테레오 케이블을 통해 사운드바에 연결합니다
5	컨트롤러		사운드바에 연결하기 위해 토글 컨트롤러를 꽂습니다
6	링크		OXS 위성 넥 스피커와 페어링하기 위해 누릅니다 (별도 구매)

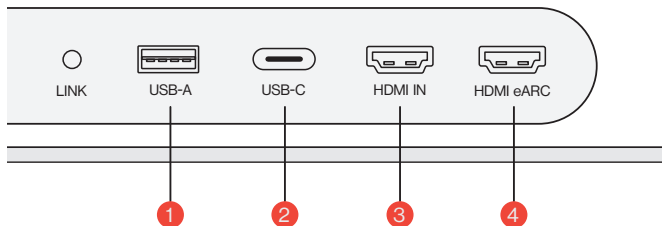
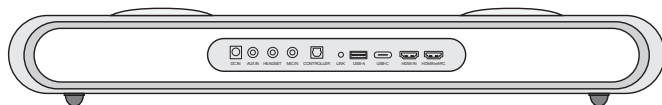



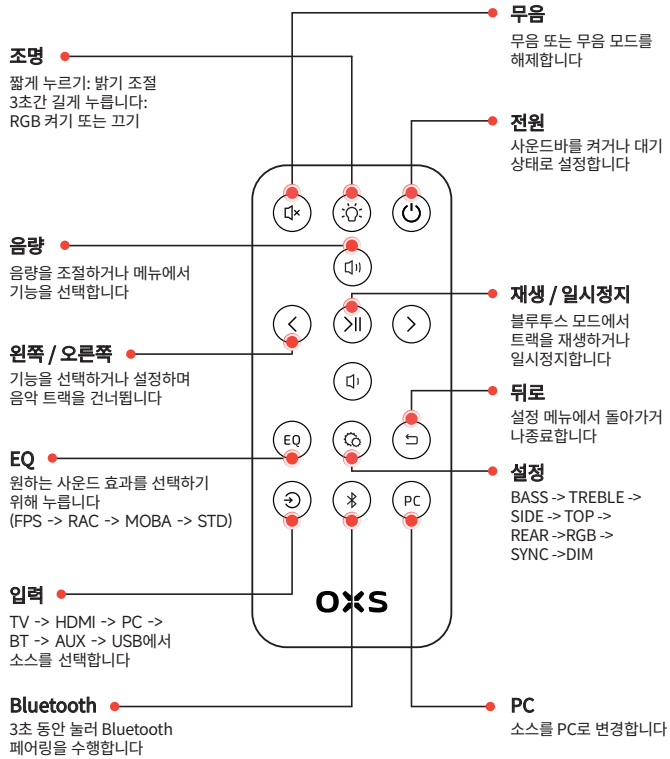

1	USB-A		동글을 꽂아 OXS 위성 넥 스피커와 연결합니다 (별도 구매)
2	USB-C		USB (C 타입) 케이블을 꽂아 사운드바를 컴퓨터에 연결합니다
3	HDMI 입력 (HDMI IN)		HDMI 케이블을 꽂아 사운드바를 게이밍 모니터나 컴퓨터에 연결합니다
4	HDMI eARC		HDMI 케이블을 꽂아 사운드바를 게이밍 콘솔에 연결합니다

## 원격

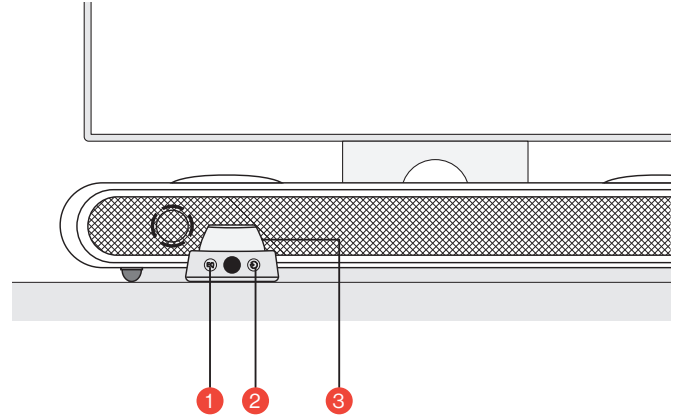

## 컨트롤러



1	<b>EQ (이퀄라이저)</b> 	눌러 원하는 사운드 효과를 선택합니다 (FPS -> RAC -> MOBA -> STD)
2	<b>입력</b> 	TV -> HDMI -> PC -> BT -> AUX -> USB에서 소스를 선택합니다
3	<b>메인 버튼</b> 	<b>3초 동안 누르고 있으면</b> 사운드바를 켜거나 대기 상태로 전환합니다
		<b>한 번 누르면</b> 사운드바의 음소거됩니다
		<b>볼륨을 조정하려면 회전합니다</b>

# 사용 방법

## 설정하기



### 2 높이 조절

분리 가능한 추가 발판을 사용하여  
사운드바의 높이를 조절하여 소리  
전달에 방해가 최대한 줄일 수  
있도록 합니다. 발판의 방향에 따라  
사운드바를 평평한 각도 또는 높은  
각도로 설정할 수 있습니다.

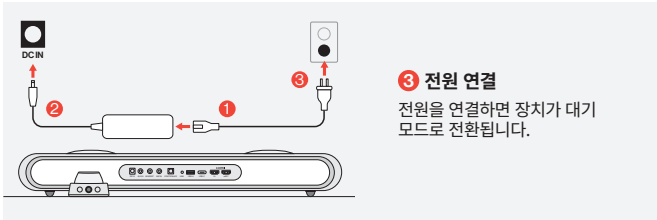
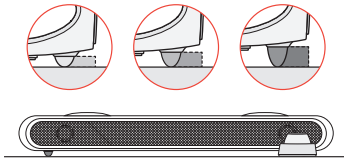

### 4 전원 켜기

버튼을 짧게 눌러 사운드바의  
전원을 켭니다.

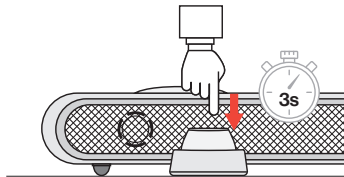

# 음원에 연결해 주십시오

## HDMI eARC/ARC 연결

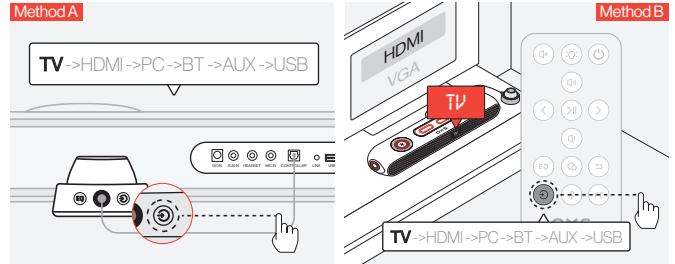
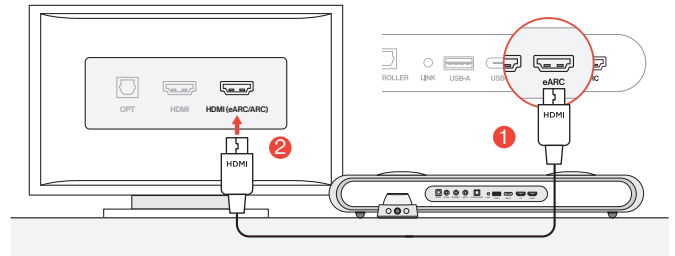

**2** 오디오 입력을 "TV"로 변경합니다.

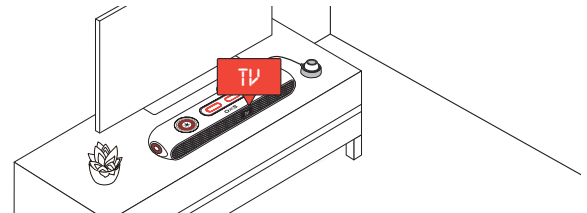

## HDMI IN을 통한 연결

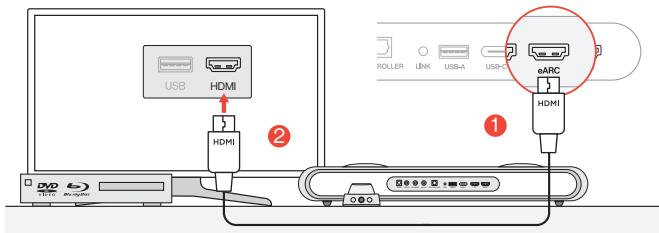

1 임의의 TV나 모니터의 HDMI 포트를 선택하고 사운드바의 HDMI OUT 포트에 연결합니다.

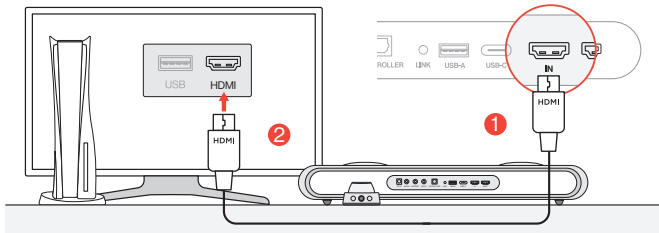

2 PC나 게임 콘솔의 HDMI 포트 중 하나를 사운드바의 HDMI IN 포트에 연결합니다.

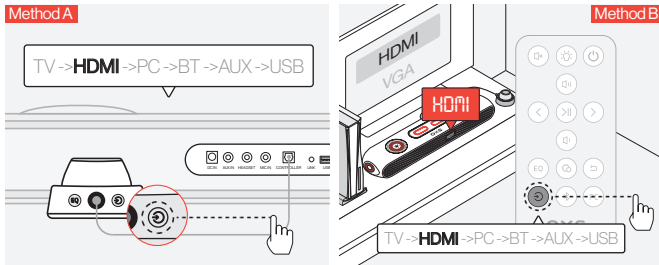

3 오디오 입력을 HDMI로 전환합니다.

## USB-C 케이블을 통한 연결

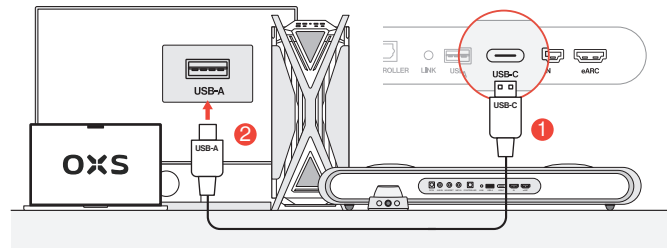

1 포함된 USB-C에서 USB-A 케이블을 사용하여 사운드바를 PC의 어느 USB-A 포트에 연결합니다.

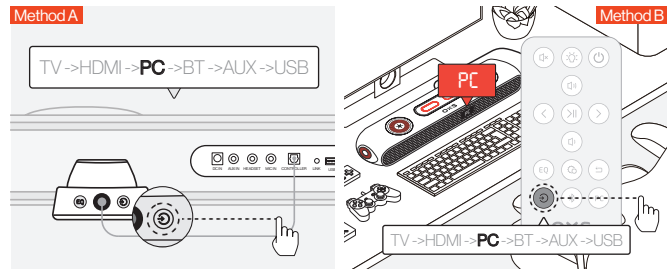

2 오디오 입력을 PC로 전환합니다.

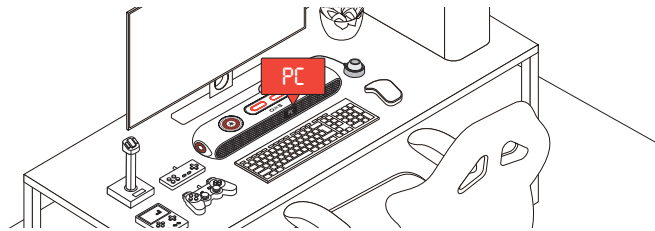



## 아날로그 케이블로 연결

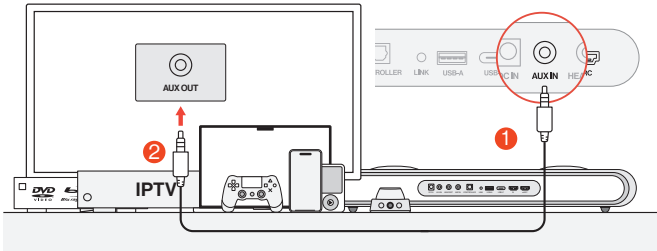

1 AUX 케이블을 사용하여 장치와 사운드바를 연결합니다.

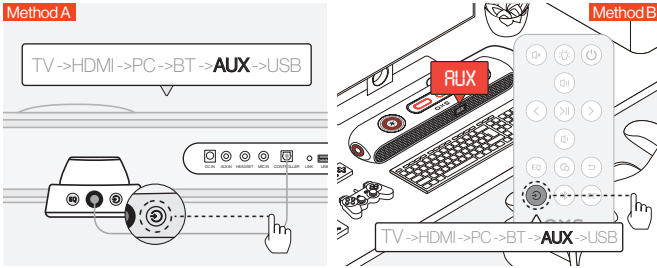

2 오디오 입력을 AUX로 전환합니다.



## 블루투스로 연결하기

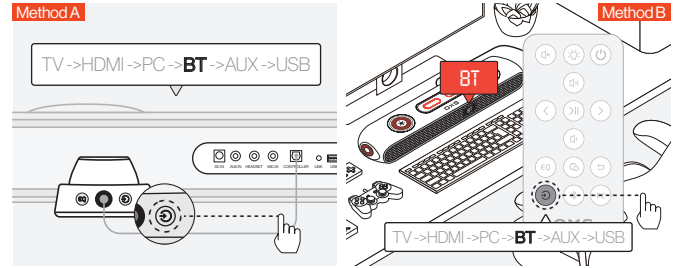

1 오디오 입력을 블루투스로 전환합니다.

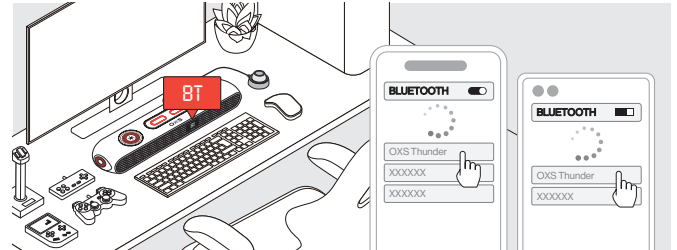

2 디바이스 화면에서 "OX5 Thunder"를 선택합니다.

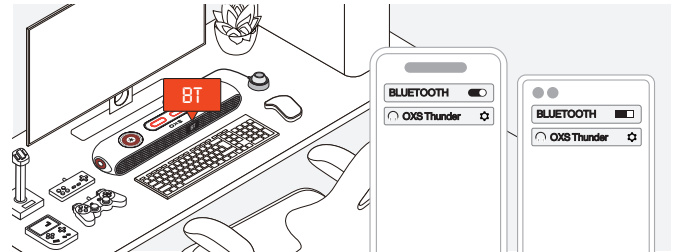

3 연결되면 사운드바의 "BT" 표시등이 안정된 상태로 유지됩니다.

## 스피커를 기본 장치로 설정하기

사운드바를 처음 사용하는 경우, 장치를 시스템의 기본 재생 장치로 설정해야 합니다.

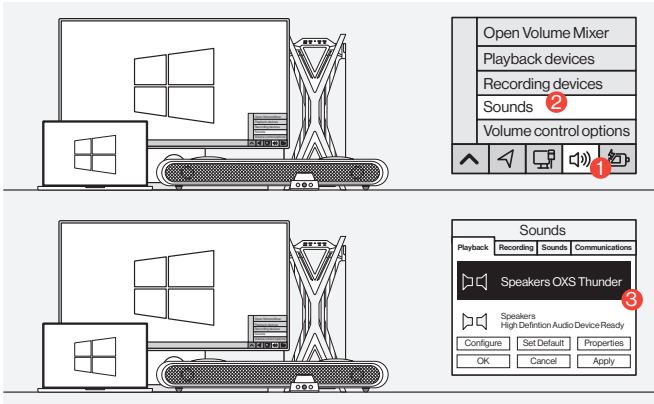

1 Windows PC 사용자용

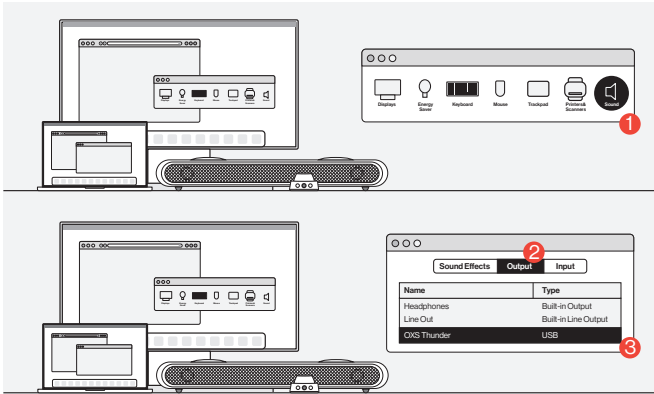

2 Mac 사용자용

## DOLBY ATMOS 활성화

만약 처음으로 사운드바를 사용한다면, Dolby Atmos는 HDMI 출력을 통해서만 사용할 수 있습니다. 게이밍 콘솔이나 PC에서 Dolby Atmos를 활성화해야 할 수도 있습니다. 자세한 지침은 아래 사이트를 참조하시기 바랍니다:

• <https://games.dolby.com/atmos/documentation/#Platforms>

ماذا في الداخل

AE - 02

• مخطط الجهاز

AE - 03

• التحم عن بعد

AE - 05

• التحكم بالتبديل

AE - 06

طريقة الاستخدام

AE - 07

الاتصال بمصدر صوت

AE - 08

• الاتصال عبر HDMI eARC/ARC

AE - 08

• الاتصال عبر مدخل HDMI IN

AE - 09

• الاتصال عبر كابل USB-C

AE - 10

• الاتصال عبر الكابل التناظري

AE - 11

• الاتصال عبر بلوتوث

AE - 12

• تعيين السماعه كجهاز افتراضي

AE - 13

تمكين DOLBY ATMOS

AE - 14

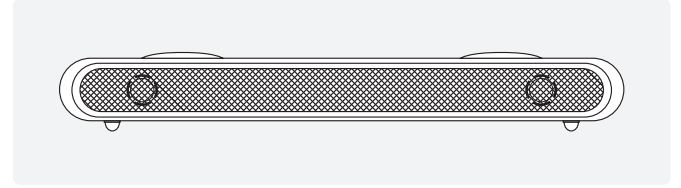

ساونديار 1 × OXS Thunder

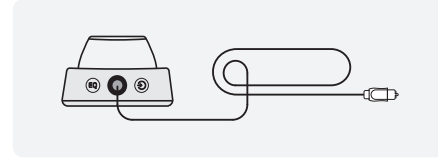

وحدة التحكم بالتبديل 1 ×



قدم قابلة للانعكاس لتعديل زاوية جهاز ساونديار

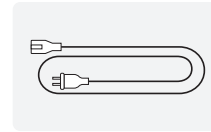

كابل الطاقة 1 ×

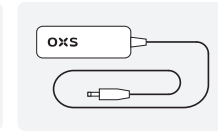

محول الطاقة 1 ×

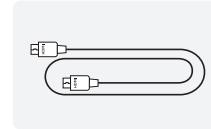

كابل HDMI 1 ×

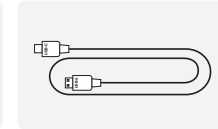

كابل USB A إلى C 1 ×

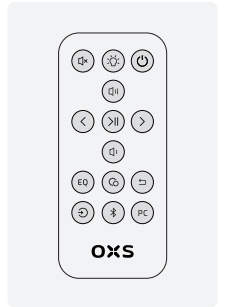

جهاز تحكم مع بطارية بالداخل

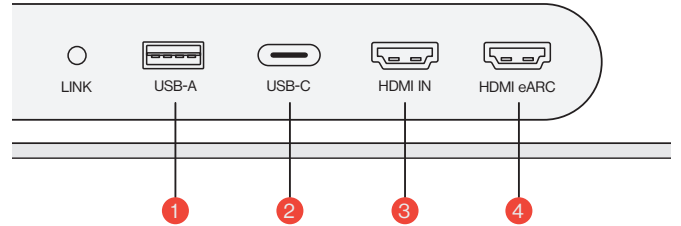
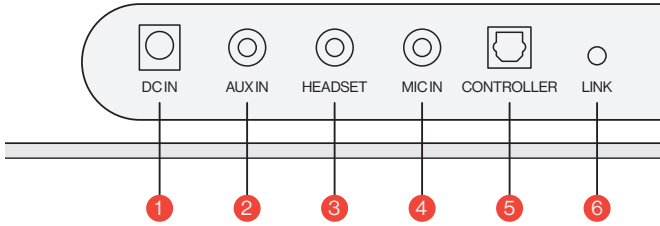
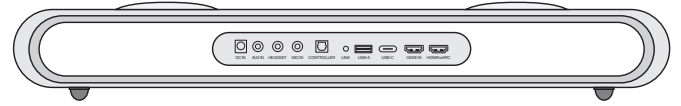
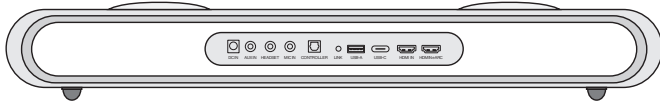

1	مزود الطاقة	بتشغيل جهاز ساونديبار باستخدام محول الطاقة المزود.
2	AUX IN	مدخل صوت AUX.
3	مدخل سماعات الرأس	قم بتوصيل سلك سماعات الرأس أو سماعات الأذن لتوصيلها بجهاز ساونديبار.
4	مدخل الميكروفون MIC IN	قم بتوصيل ميكروفون خارجي بجهاز ساونديبار عبر كابل ستيريو 3.5 ملم.
5	وحدة التحكم	قم بتوصيل سلك وحدة التحكم بالتبديل لتوصيلها بجهاز ساونديبار.
6	الربط	اضغط لإقران مكبر الصوت OXS Satellite للرقبة (يتم شراؤه بشكل منفصل).

1	USB-A	قم بتوصيل الدونجل لتوصيل مكبر الصوت للرقبة OXS Satellite (يتم شراؤه بشكل منفصل).
2	USB-C	لتوصيل جهاز ساونديبار USB (النوع C) قم بتوصيل كابل بجهاز الحاسوب.
3	HDMI IN	لتوصيل جهاز ساونديبار بشاشة HDMI قم بتوصيل كابل ألعاب أو جهاز الحاسوب.
4	HDMI eARC	قم بتوصيل HDMI لتوصيل جهاز ساونديبار بوحدة التحكم بالألعاب بتوصيل كابل.

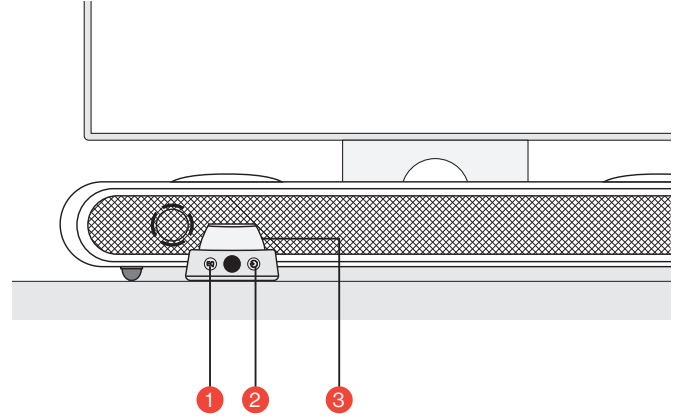
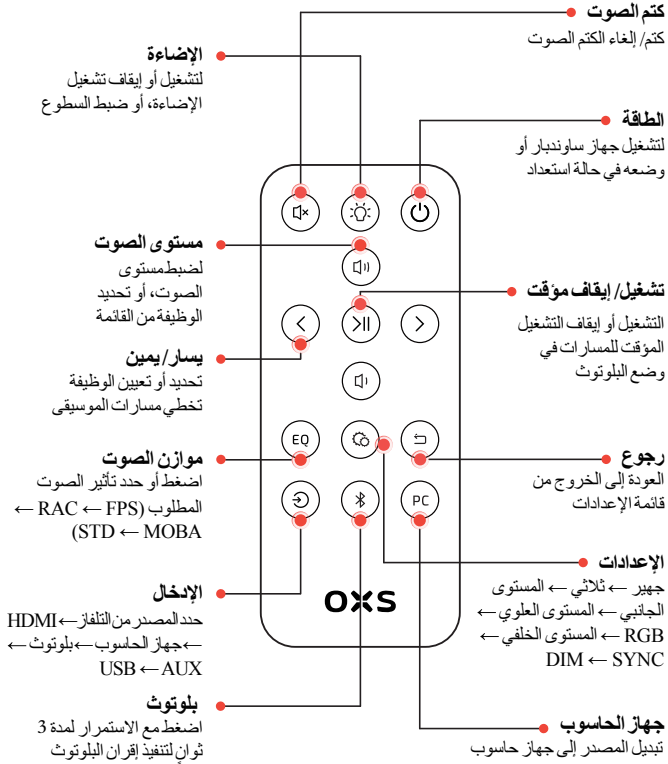

1	موازن الصوت EQ	بولمطلا توصلنا ريبثأت ددح وأ طغضا ( STD ← MOBA ← RAC ← FPS )
2	الإدخال	حدد المصدر من التلفاز ← HDMI ← جهاز بلوتوث ← الحاسوب ← AUX ← USB
3	الزر الرئيسي	اضغط مع الاستمرار 3 ثوانٍ لتشغيل جهاز ساونديبار أو وضعه في حالة استعداد
		ضغطة واحدة كتم جهاز ساونديبار
		أديري لضبط مستوى الصوت

## طريقة الاستخدام

**2 ضبط الارتفاع**

الزوج الإضافي من القدم القابلة للفك يتيح لك تغيير ارتفاع جهاز ساونديبار لضمان توزيع الصوت بأقل قدر ممكن من العوائق. بناء على اتجاه القدم، يمكنك ضبط جهاز ساونديبار على زاوية مسطحة أو مرفوعة

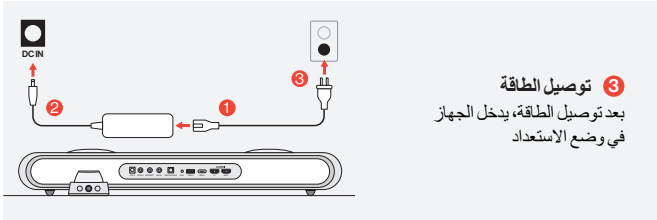
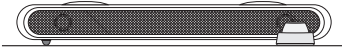
**4 التشغيل**

شغل جهاز ساونديبار بضغط قصيرة على الزر

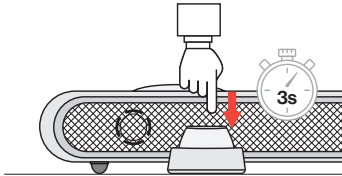

## الاتصال عبر HDMI eARC/ARC

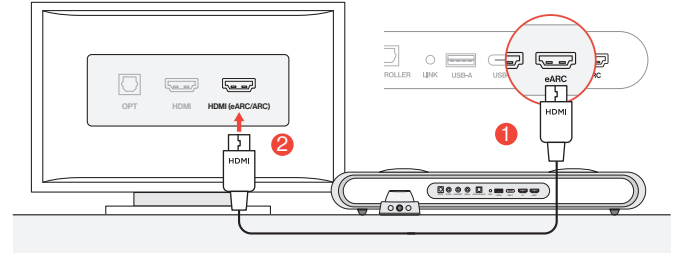

**1** HDMI على التلفاز الخاص بك باستخدام كابل HDMI المزود  
قم بتوصيل جهاز ساونديبار بأي من منافذ (eARC/ARC)

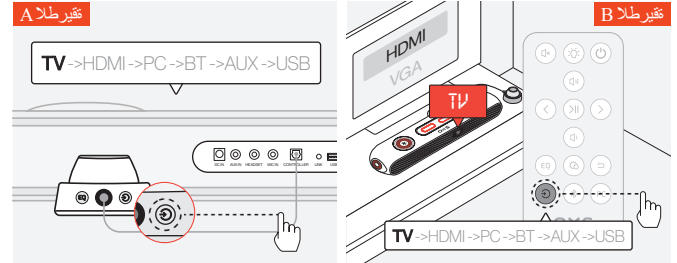

**2** تبديل مدخل الصوت إلى التلفاز

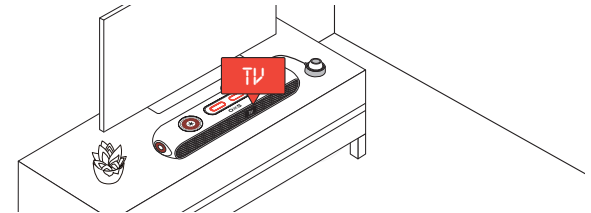

## الاتصال عبر مدخل HDMI IN

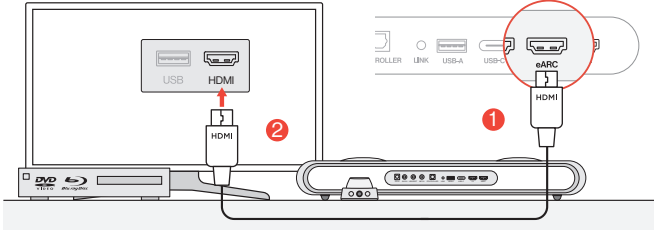

1 قم بتوصيل أي من منافذ HDMI على تلفازك أو الشاشة بمنفذ HDMI OUT على جهاز سونديبار

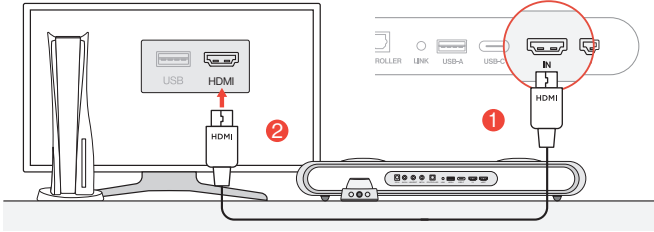

2 على جهازك الحاسوب أو وحدة التحكم بالألعاب بمنفذ HDMI IN على جهاز سونديبار  
قم بتوصيل أي من منافذ HDMI

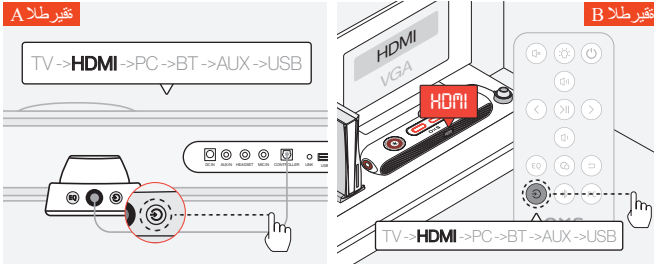

3 تبديل مدخل الصوت إلى HDMI

## الاتصال عبر كابل USB-C

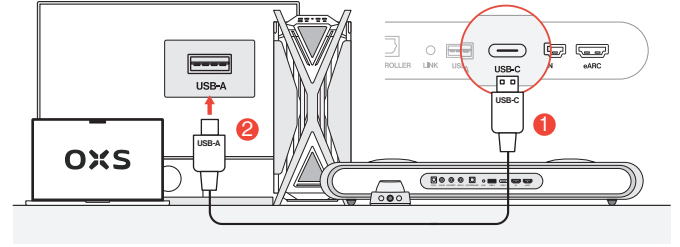

1 USB-A على جهازك الحاسوب باستخدام كابل USB-C إلى USB-A  
قم بتوصيل جهاز سونديبار بأي من منافذ

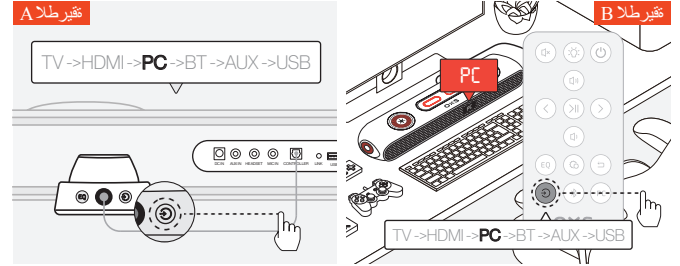

2 تبديل مدخل الصوت إلى جهاز حاسوب

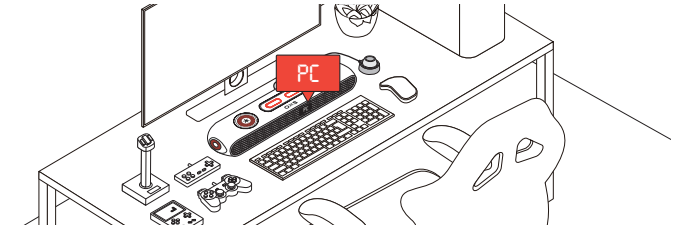

## الاتصال عبر الكابل التناظري

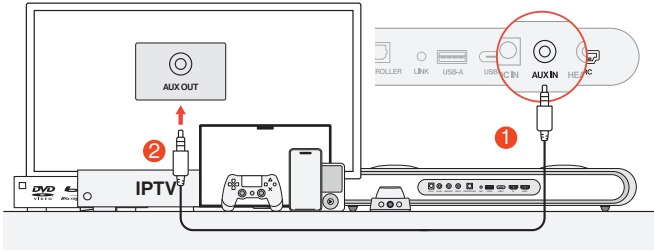

1 قم بتوصيل الجهاز وجهاز ساونديار باستخدام كابل AUX

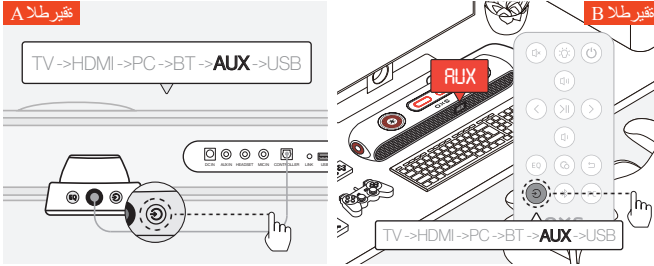

2 تبديل مدخل الصوت إلى AUX

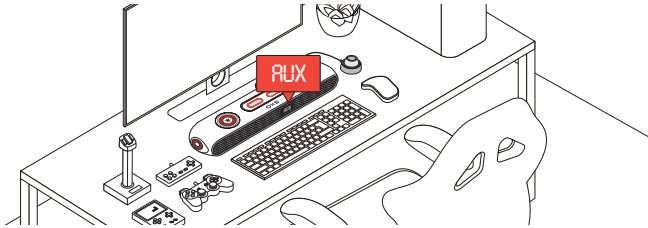

## الاتصال عبر بلوتوث

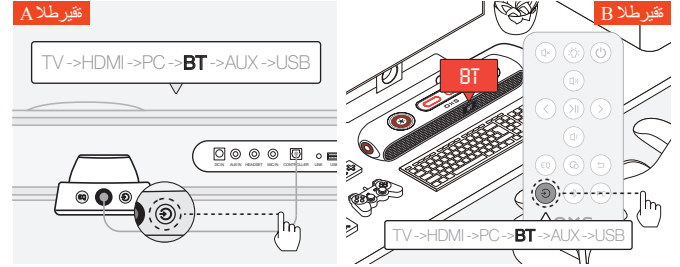

1 تبديل مدخل الصوت إلى بلوتوث

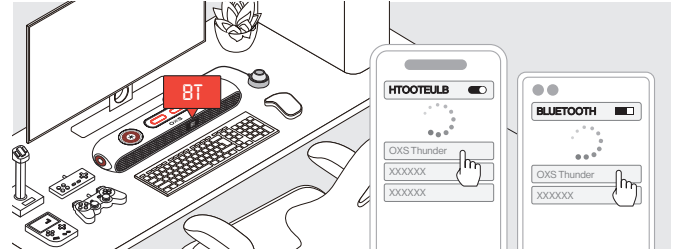

2 اختر "OXs Thunder" على شاشة الجهاز

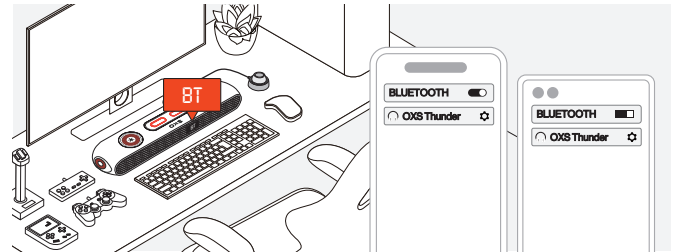

3 عند الاتصال بنجاح، سيظهر مؤشر البلوتوث "BT" على جهاز ساونديار ثابتاً



## تعيين السماعه كجهاز افتراضي

إذا كنت تستخدم جهاز ساونديبار للمرة الأولى، قد تحتاج إلى ضبط الجهاز كجهاز التشغيل الافتراضي للنظام الخاص بك

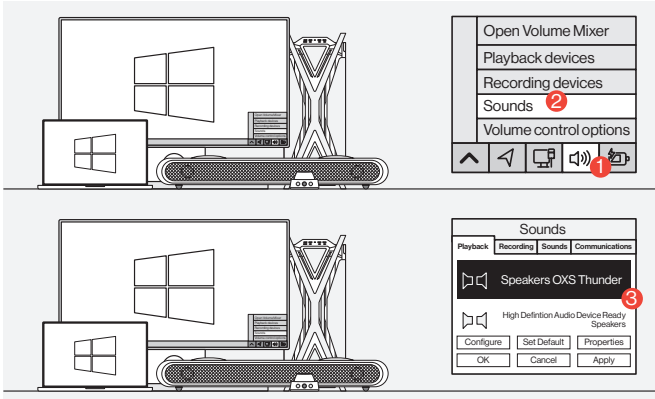

1 مستخدمى نظام ويندوز على جهاز الحاسوب

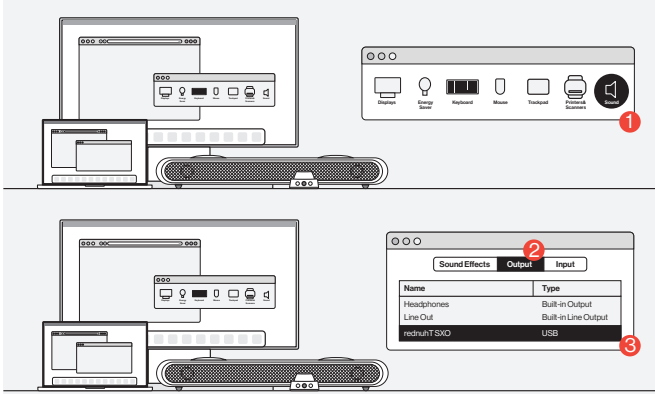

2 مستخدمى نظام MAC

## تمكين DOLBY ATMOS

إذا كنت تستخدم شريط الصوت للمرة HDMI متوفر فقط عبر مخرج Dolby Atmos رعى ملاحظة أن على جهاز الألعاب أو الكمبيوتر الخاص بك. لمزيد من التعليمات Dolby Atmos الأولى ، قد تحتاج إلى تمكين :، يرجى زيارة المواقع التالية

<https://games.dolby.com/atmos/documentation/#Platforms>

