



OXS Satellite Neck Speaker V1.0

Thank you for purchasing this OXS product.  
If you have any questions, please contact us at: [service@oxsaudio.com](mailto:service@oxsaudio.com)  
To receive more complete service, please follow us at [www.oxsaudio.com](http://www.oxsaudio.com)

# User Manual

# User Manual

01

## 1 WHAT'S INSIDE

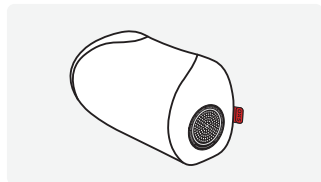

OXS Satellite Neck Speaker

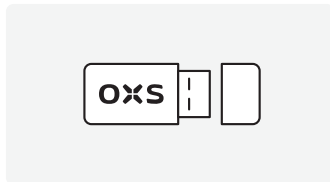

USB A Dongle

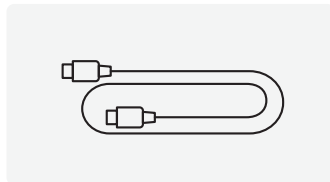

USB C to C Cable

## 2 BUTTONS



### Power

Press & hold 3s to power on or off the device.

### Link

Press & hold 3s to enter connection mode.

## 3 LEDS



**White Pulsing Slow**  
Not connected



**White Flashing Quick**  
Enter pairing mode,  
waiting for connection



**Solid White**  
Connected



**On 1s, Off 5s**  
Standby mode



**Red Pulsing**  
Low battery



**Red LED Out**  
Charging Complete



**Solid Red**  
Battery charging

## 4 CONNECTION

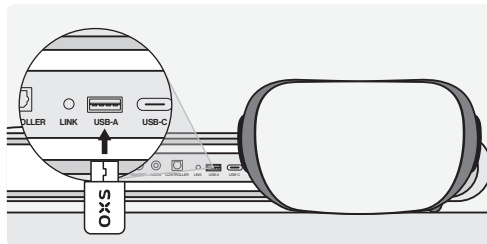

1. Plug the USB-A dongle on the back of your OXS Thunder Bar.

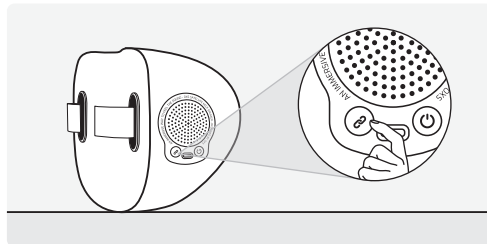

3. Press and hold the LINK button on the OXS Satellite Neck Speaker.

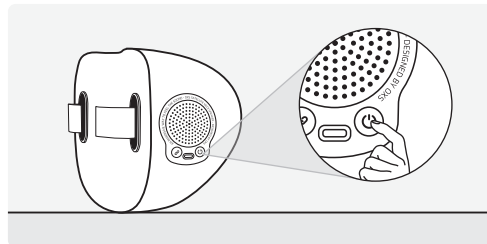

2. Power on the OXS Satellite Neck Speaker.

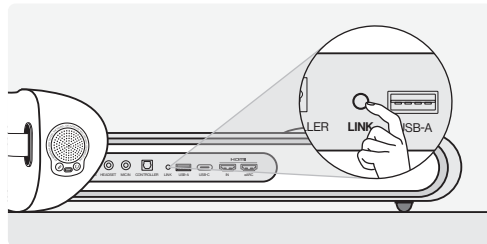

4. Press and hold the LINK button on the back of your OXS Thunder Bar.

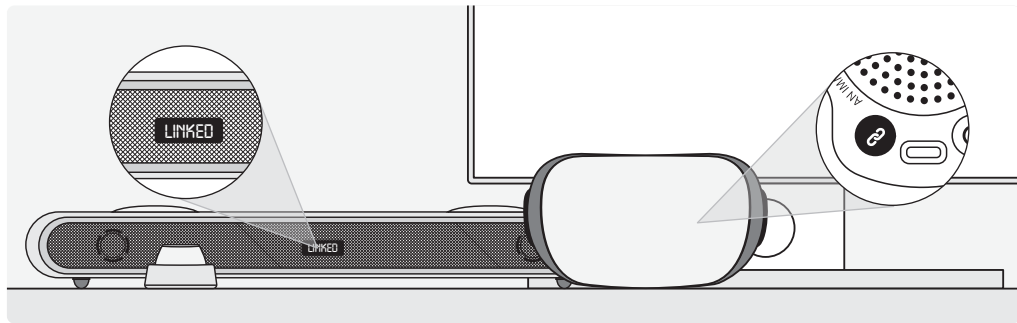

5. The display screen on the soundbar will show LINKED, while there will be solid white on the LINK button of the Satellite Neck Speaker indicating the solid connection.

## 5 ADJUSTING THE VOLUME

You can adjust the volume on the OXS Satellite Neck Speaker in the menu of the OXS Thunder Bar.

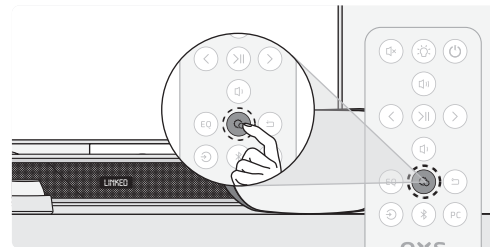

1. Press the settings button on the remote of the OXS Thunder Bar.

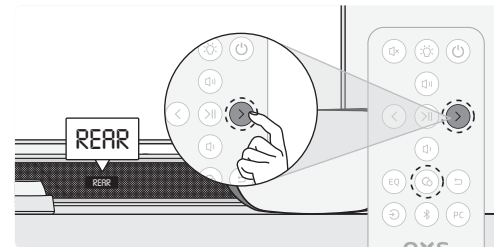

2. Press > to navigate the menu to REAR.

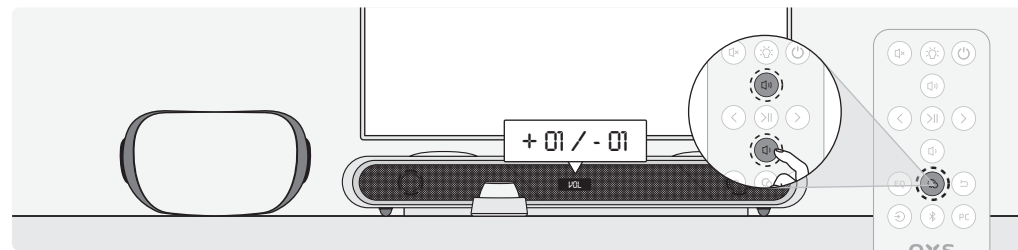

3. Press VOL+ or VOL- to adjust the volume of the OXS Satellite Neck Speaker.

## ⑥ CHARGE

Charge your OXS Satellite Neck Speaker quickly and easily with the included USB-C to C cable. For fastest charging, use a Quick Charge compatible adapter.

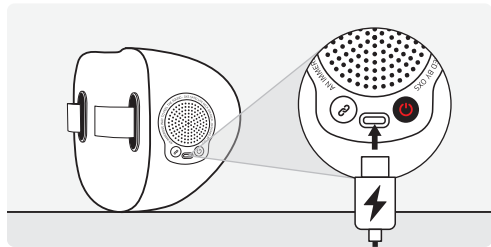

## ⑦ AUTO-STANDBY

The satellite neck speaker automatically turns off with the soundbar (when plugged in) and powers back on when the soundbar does.

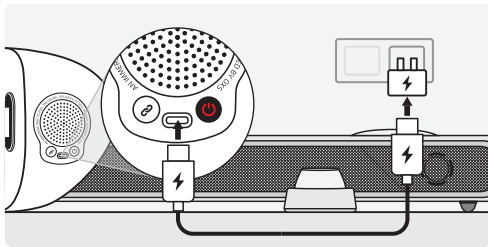

### Notes:

**Wired Operation:** This feature requires the neck speaker to be plugged into an adapter.

**Wireless Power Saving:** The neck speaker turns off after 15 minutes of inactivity on battery power.

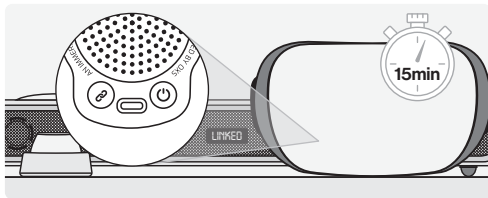

# Benutzerhandbuch

# 02

## 1 LIEFERUMFANG

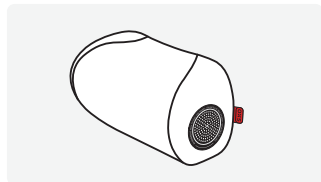

OXS Satelliten-Nackenlautsprecher



USB-A-Dongle

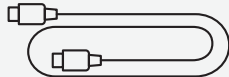

USB-C-zu-C-Kabel

## 2 TASTEN



 **Ein/Aus**

Drücken & halten Sie 3s, um das Gerät ein- oder auszuschalten.

 **Verbinden**

Drücken & halten Sie 3s, um in den Verbindungsmodus zu gelangen.

## 3 LEDES



**Weiß pulsierend langsam**  
Nicht verbunden



**Weiß blinkend schnell**  
Tritt in den Kopplungsmodus ein, wartet auf Verbindung



**Rot pulsierend**  
Niedriger Akkustand



**Rote LED aus**  
Ladevorgang abgeschlossen



**Durchgehend weiß**  
Verbunden



**1s an, 5s aus**  
Standby-Modus



**Durchgehend rot**  
Akku wird geladen

## 4 VERBINDUNG

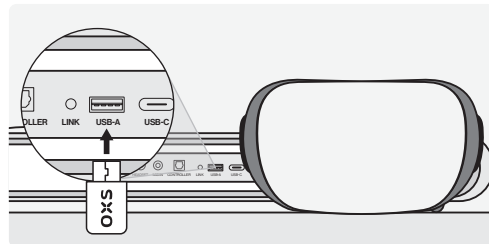

1. Stecken Sie den USB-A-Dongle an die Rückseite Ihrer OXS Thunder Bar.

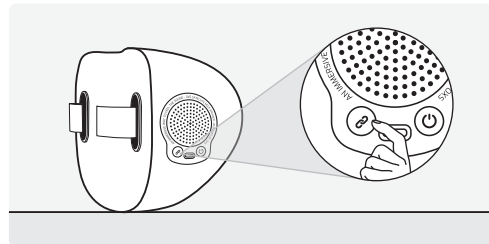

3. Drücken und halten Sie den VERBINDEN-Knopf am OXS Satelliten-Nackenlautsprecher.

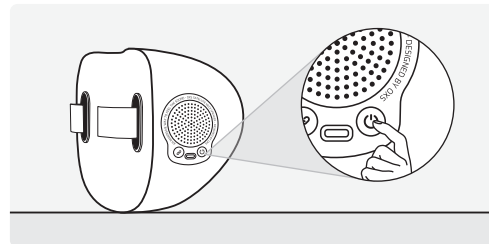

2. Schalten Sie den OXS Satelliten-Nackenlautsprecher ein.

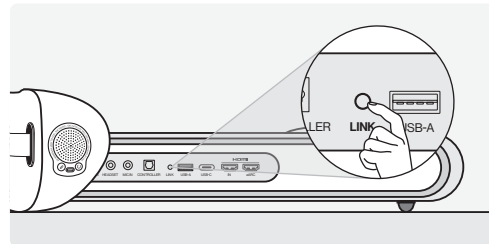

4. Drücken und halten Sie den LINK-Knopf an der Rückseite Ihrer OXS Thunder Bar.

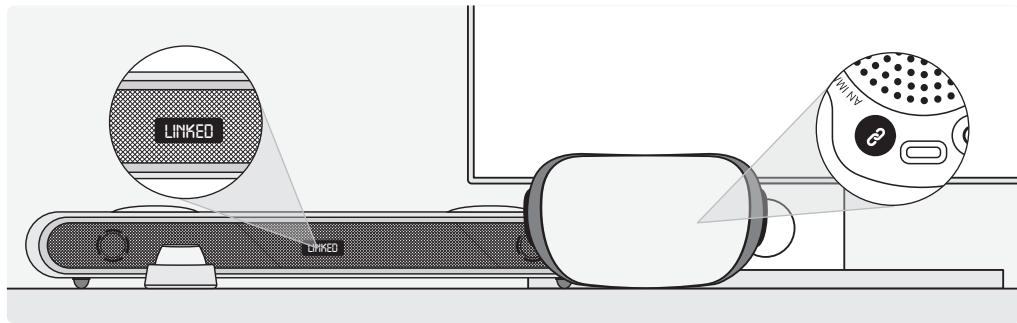

5. Der Bildschirm an der Soundbar wird LINKED anzeigen, während am VERBINDEN-Knopf des Satelliten-Nackenlautsprechers ein durchgehendes Weiß zu sehen ist, was eine stabile Verbindung anzeigt.

## 5 LAUTSTÄRKE EINSTELLEN

Sie können die Lautstärke am OXS Satelliten-Nackenlautsprecher im Menü der OXS Thunder Bar einstellen.

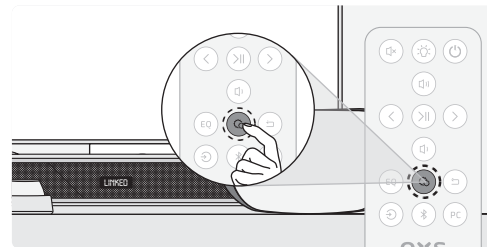

1. Drücken Sie die Einstellungstaste auf der Fernbedienung der OXS Thunder Bar.

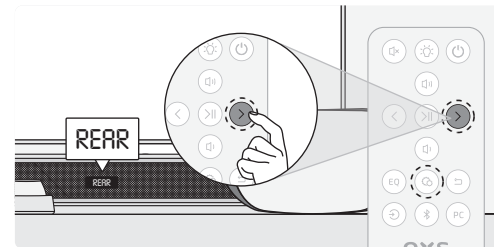

2. Drücken Sie >, um im Menü zu REAR zu navigieren.

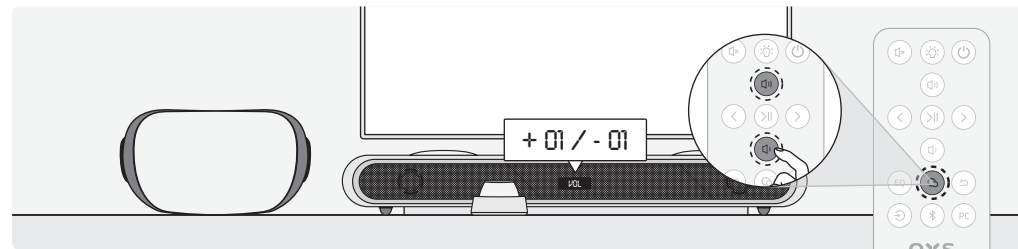

3. Drücken Sie VOL+ oder VOL-, um die Lautstärke des OXS Satelliten-Nackenlautsprechers anzupassen.

## ⑥ LADEN

Laden Sie Ihren OXS Satelliten-Nackensprecher schnell und einfach mit dem mitgelieferten USB-C-zu-C-Kabel. Für das schnellste Laden verwenden Sie einen Schnellladen (Quick Charge) kompatiblen Adapter.

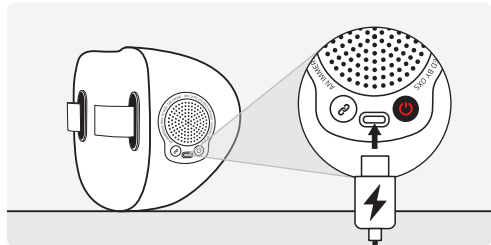

## ⑦ AUTO-STANDBY

Der Satelliten-Nackensprecher schaltet sich automatisch mit der Soundbar aus (wenn eingesteckt) und wieder ein, wenn die Soundbar eingeschaltet wird.

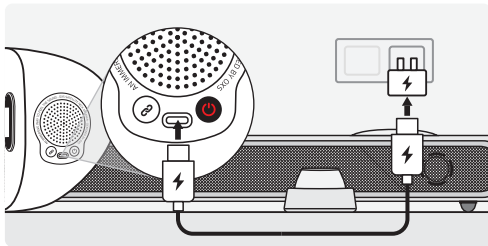

### Hinweise:

**Kabelbetrieb:** Diese Funktion erfordert, dass der Nackensprecher an einen Adapter angeschlossen wird.

**Kabelloses Energiesparen:** Der Nackensprecher schaltet sich nach 15 Minuten Inaktivität im Batteriebetrieb aus.

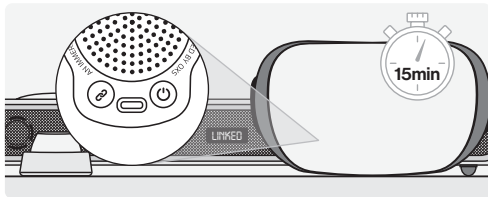

# Manuale utente

# 03



## 1 COSA CONTIENE

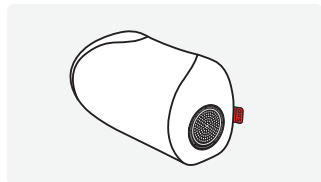

Altoparlante da collo satellite OXS

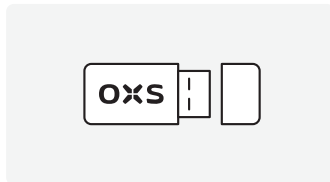

Chiave USB A

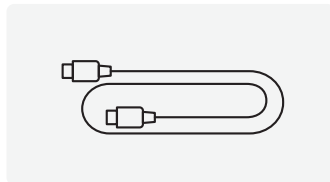

Cavo da USB C a C

## 2 PULSANTI



### Alimentazione

Tenere premuto 3s per accendere o spegnere il dispositivo.

### Collegamento

Tenere premuto per 3 secondi per accedere alla modalità di collegamento.

## 3 LEDS

 **Impulsi bianchi lenti**  
Nessuna connessione

 **Lampeggi rapidi bianchi**  
Entrare in modalità di accoppiamento, in attesa di connessione

 **Rosso pulsante**  
Batteria scarica

 **LED rosso spento**  
Carica completata

 **Bianco sempre acceso**  
Connesso

 **Accesso 1s, spento 5s**  
Modalità standby

 **Rosso sempre acceso**  
Batteria in carica

## 4 CONNESSIONE

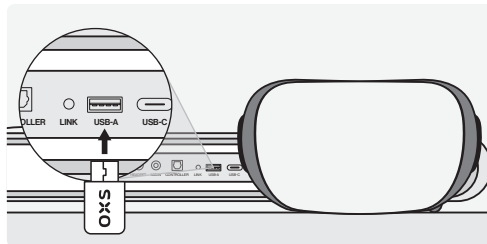

1. Collegare il dongle USB-A al retro della OXS Thunder Bar.

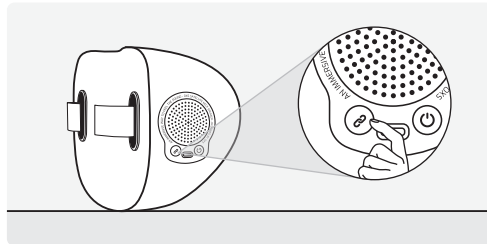

3. Tenere premuto il pulsante COLLEGAMENTO sul altoparlante da collo satellite OXS.

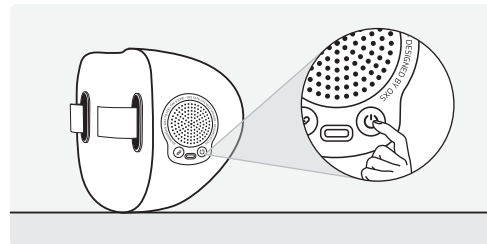

2. Accendere l'altoparlante da collo satellite OXS.

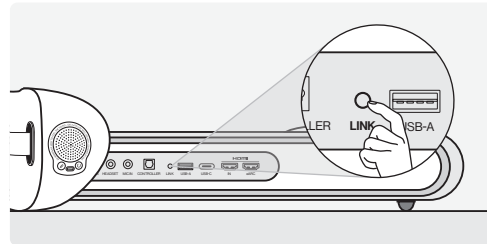

4. Tenete premuto il pulsante LINK sul retro della OXS Thunder Bar.

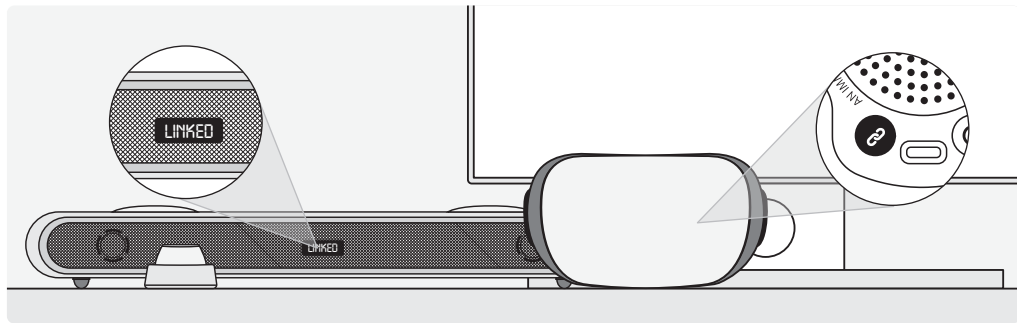

5. Il display della soundbar mostrerà LINKED, mentre il pulsante COLLEGAMENTO sul altoparlante da collo satellite sarà bianco sempre acceso, a indicare una connessione sempre acceso.

## 5 REGOLAZIONE DEL VOLUME

È possibile regolare il volume del altoparlante da collo satellite OXS nel menu OXS Thunder Bar.

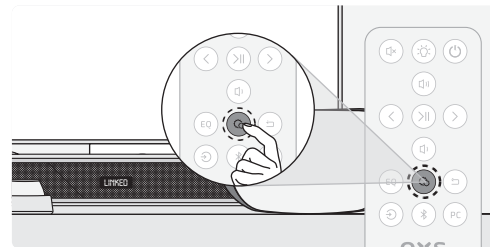

1. Premere il pulsante di regolazione sul telecomando OXS Thunder Bar.

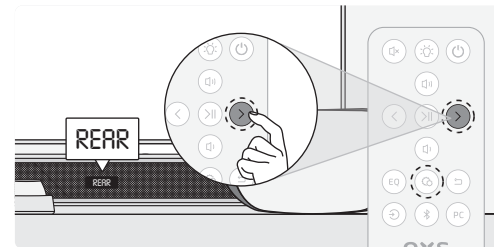

2. Premere > per spostarsi su REAR (POSTERIORE).

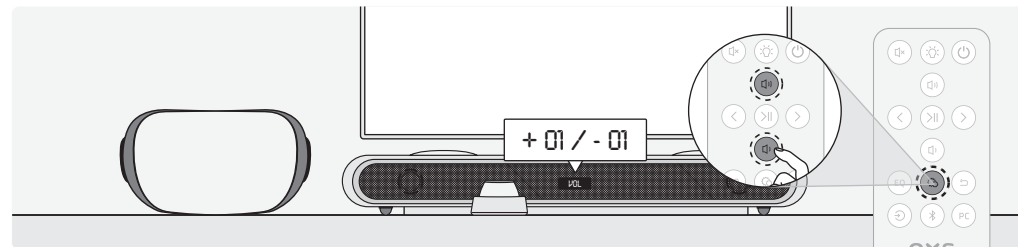

3. Premere VOL+ o VOL- per regolare il volume del altoparlante da collo satellite OXS.

## ⑥ RICARICA

Il cavo USB-C-C in dotazione consente di ricaricare l'altoparlante da collo satellite OXS in modo rapido e semplice. Per una ricarica più rapida, utilizzare un adattatore compatibile con Quick Charge.

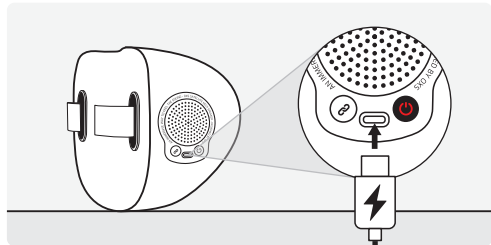

## ⑦ STANDBY AUTOMATICO

Il altoparlante da collo satellite OXS si spegne automaticamente quando viene collegata la barra audio e si riaccende quando la barra audio viene spenta.

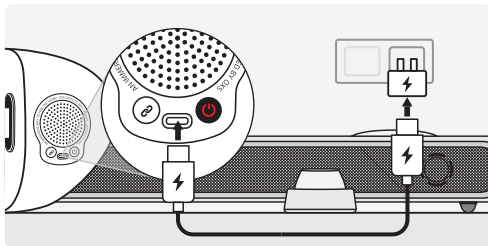

### Note:

**Funzionamento con cavo:** questa funzione richiede che il diffusore da collo sia collegato a un adattatore.

**Risparmio energetico wireless:** il diffusore da collo si spegne dopo 15 minuti di inattività della batteria.

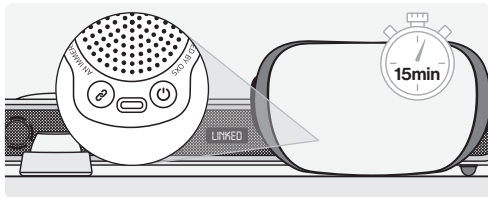

# Manuel d'utilisation

# 04

## 1 ÉLÉMENTS INCLUS

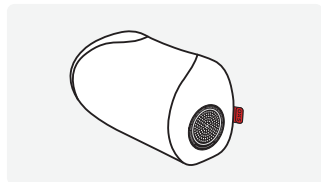

Haut-Parleur OXS Satellite Neck

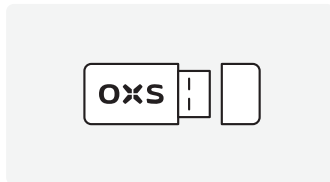

Clé USB A

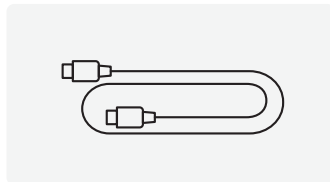

Câble USB C à C

## 2 BOUTONS



### Alimentation

Appuyez et maintenez 3 s pour allumer ou éteindre l'appareil.

### Lien

Appuyer et maintenir 3 s pour entrer en mode connexion.

## 3 LEDS



**Pulsations Blanches Lentes**

Pas de connexion



**Blanc Clignotant Rapidement**

Entrer en mode d'appairage, en attente de connexion



**Rouge Pulsations**

Batterie faible



**LED Rouge Éteinte**

Chargement Terminé



**Blanc Fixe**

Connecté



**Allumé 1 s, Éteint 5 s**

Mode veille



**Rouge fixe**

Chargement de la batterie

## 4 CONNEXION

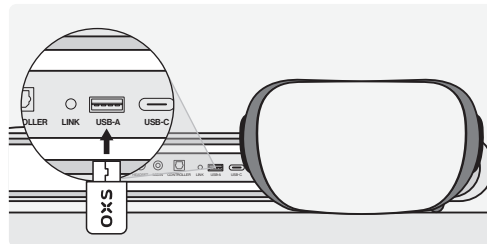

1. Branchez le dongle USB-A à l'arrière de votre OXS Thunder Bar.

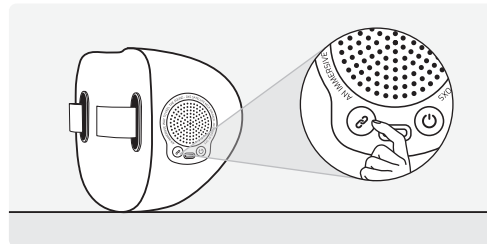

3. Appuyez et maintenez enfoncé le bouton LIEN sur le Haut-Parleur OXS Satellite Neck.

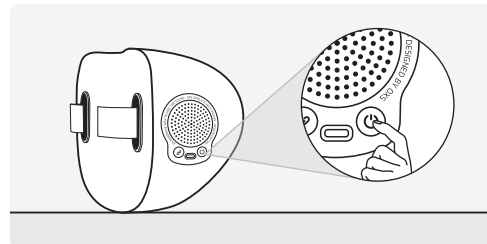

2. Allumez le Haut-Parleur OXS Satellite Neck.

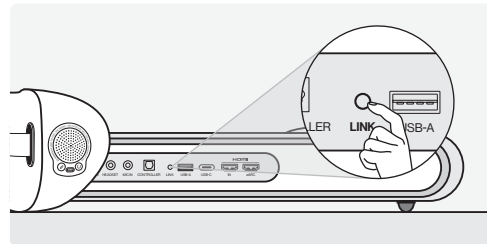

4. Appuyez et maintenez le bouton LINK (LIEN) à l'arrière de votre OXS Thunder Bar.

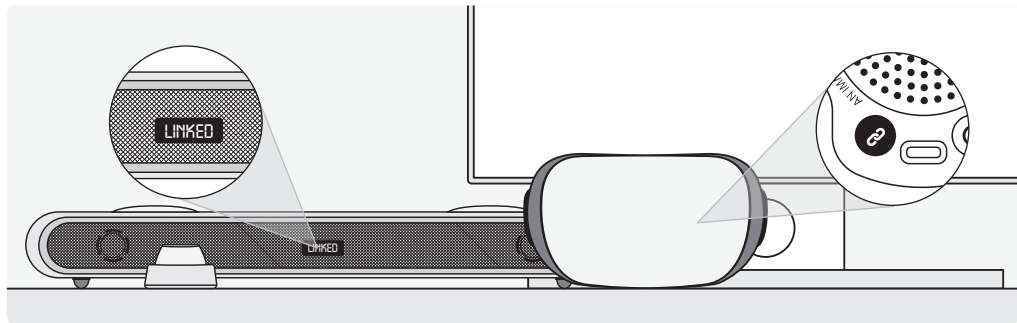

5. L'écran d'affichage de la barre de son indiquera LINKED (LIEN), tandis que le bouton LIEN de l'Haut-Parleur Satellite Neck sera blanc, indiquant une connexion solide.

## 5 RÉGLAGE DU VOLUME

Vous pouvez régler le volume du Haut-Parleur OXS Satellite Neck dans le menu de l'OXS Thunder Bar.

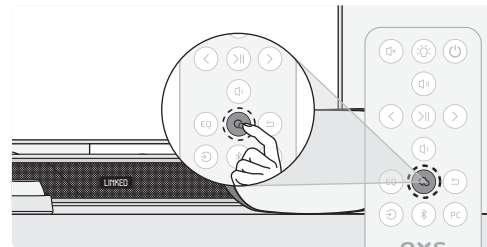

1. Appuyez sur le bouton de réglage de la télécommande de l'OXS Thunder Bar.

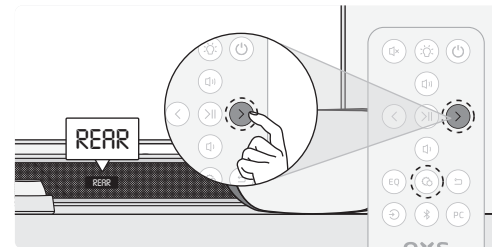

2. Appuyez sur > pour naviguer dans le menu jusqu'à REAR.

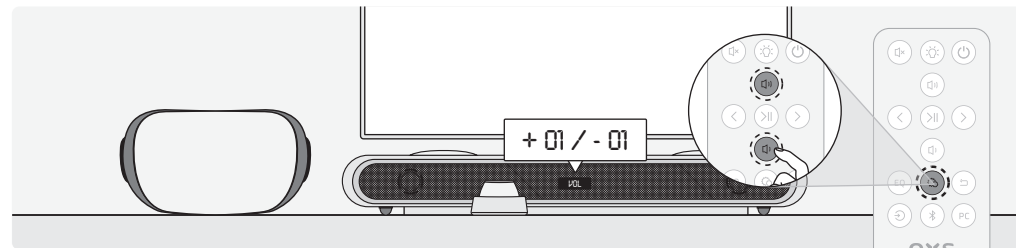

3. Appuyez sur VOL+ ou VOL- pour régler le volume du Haut-Parleur OXS Satellite Neck.

## ⑥ CHARGE

Chargez votre Haut-Parleur OXS Satellite Neck rapidement et facilement avec le câble USB-C vers C inclus. Pour une charge plus rapide, utilisez un adaptateur compatible avec Quick Charge.

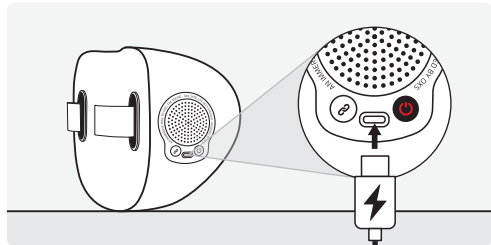

## ⑦ MISE EN VEILLE AUTOMATIQUE

L'enceinte Satellite Neck s'éteint automatiquement avec la barre de son (lorsqu'elle est branchée) et se rallume lorsque la barre de son s'éteint.

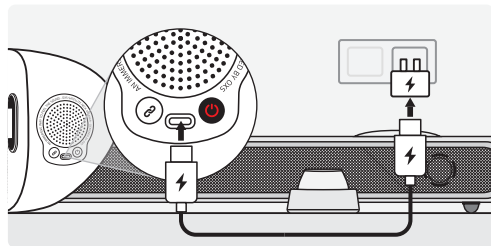

### Remarques:

**Fonctionnement câblé :** Cette fonction nécessite que le haut-parleur tour de cou soit branché sur un adaptateur.

**Économie d'énergie sans fil :** Le haut-parleur de cou s'éteint après 15 minutes d'inactivité sur la batterie.

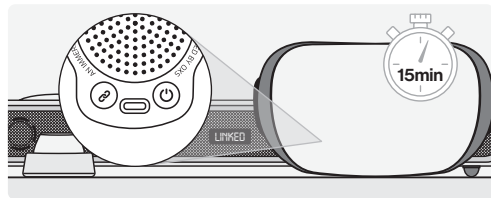

# Manual de Usuario

# 05

## 1 CONTENIDO DEL EMBALAJE

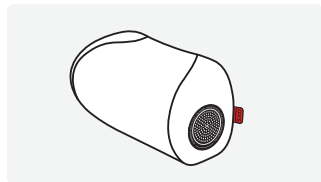

Parlante Satelital de Cuello OXS

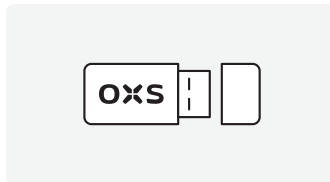

USB A Portátil

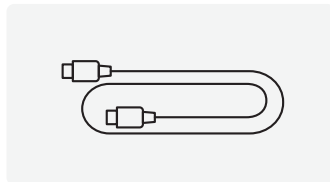

Cable USB C a C

## 2 BOTONES



### Encender

Mantén pulsado por 3 s para encender o apagar el dispositivo.

### Vincular

Mantén pulsado por 3 s para ingresar al modo de conexión.

## 3 LEDS



**Parpadeo Lento en Blanco**  
No conectado



**Parpadeo Rápido en Blanco**  
Ingresando modo de vinculación, esperando conexión



**Parpadeo en Rojo**  
Batería baja



**LED Rojo Apagado**  
Carga Completada



**Blanco estable**  
Conectado



**Encendido 1 s, Apagado 5 s**  
Modo de espera



**Rojo Estable**  
Carga de batería

## 4 CONEXIÓN

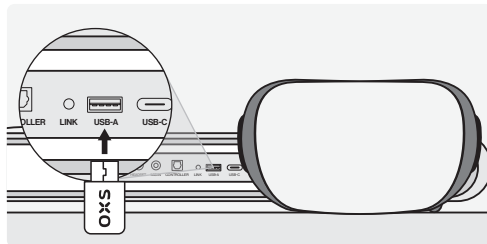

1. Enchufa el USB-A portátil en la parte trasera de tu OXS Thunder Bar.

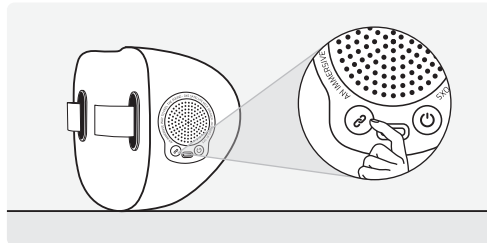

3. Mantén pulsado el botón VINCULAR en el Parlante Satelital de Cuello OXS.

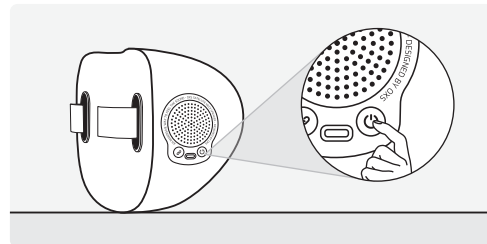

2. Enciende el Parlante Satelital de Cuello OXS.

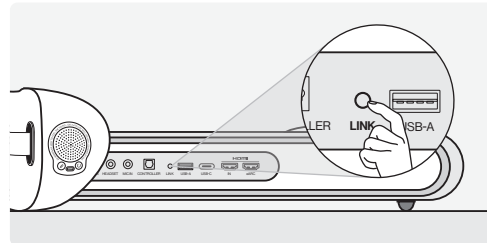

4. Mantén pulsado el botón LINK (VINCULAR) en la parte trasera de tu OXS Thunder Bar.

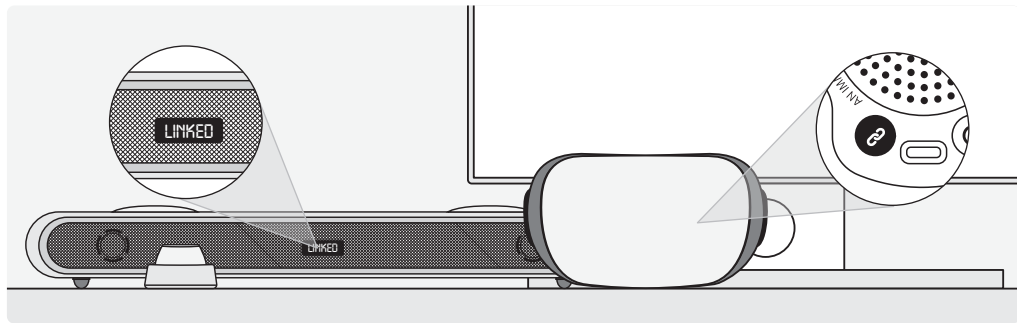

5. La pantalla de visualización de la barra de sonido mostrará LINKED (VINCULADO), y el botón de VINCULAR de Parlante Satelital de Cuello esté en blanco estable indicando una conexión estable.

## 5 AJUSTE DEL VOLUMEN

Puedes ajustar el volumen del Parlante Satelital de Cuello OXS en el menú de la OXS Thunder Bar.

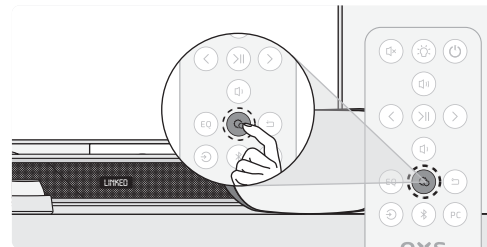

1. Pulsa el botón de configuraciones en el control remoto de la OXS Thunder Bar.

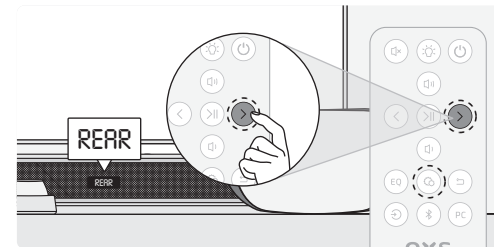

2. Pulsa > para navegar el menú hasta REAR (ATRÁS).

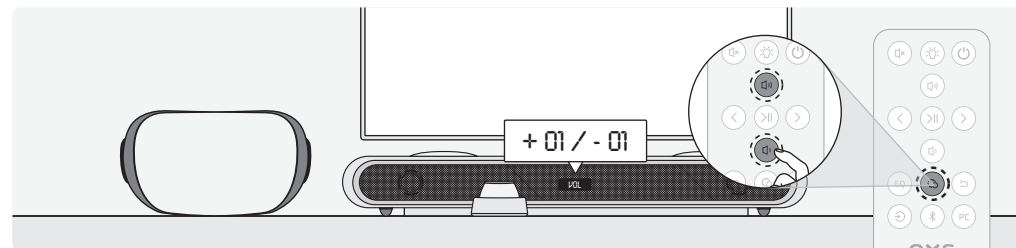

3. Pulsa VOL + o VOL - para ajustar el volumen del Parlante Satelital de Cuello OXS.



## ⑥ CARGAR

Carga tu Parlante Satelital de Cuello OXS rápidamente y fácilmente con el cable USB-C a C. Para una carga más rápida, usa un adaptador compatible con Carga Rápida.

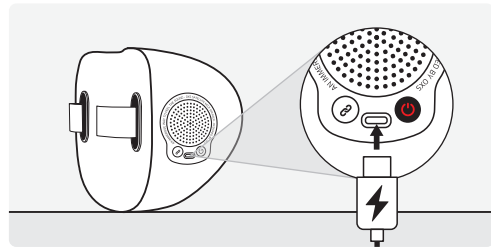

## ⑦ MODO DE ESPERA AUTOMÁTICO

El Parlante Satelital de Cuello se apagará automáticamente con la barra de sonido (si está conectado) y se volverá a encender cuando la barra de sonido lo haga.

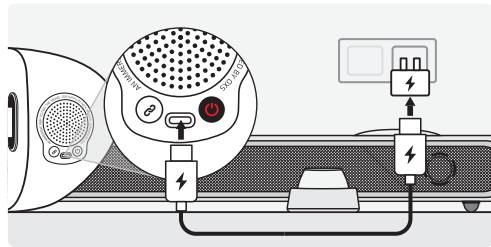

### Notas:

**Operación con cable:** Esta función requiere conectar un parlante de cuello a un adaptador.

**Ahorro de energía inalámbrico:** El parlante de cuello se apagará luego de 15 minutos de inactividad si está alimentado por batería.

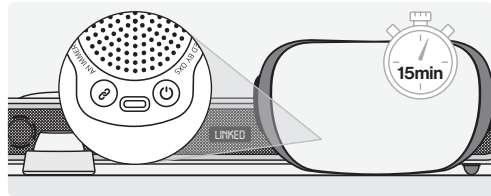

# Руководство пользователя

# 06

## 1 ЧТО ВНУТРИ

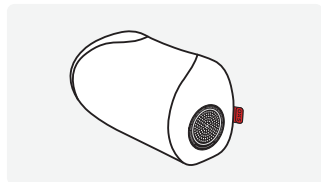

Спутниковый шейный динамик OXS

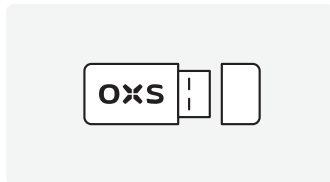

Ключ доступа USB A

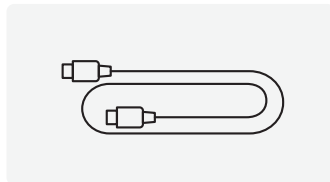

USB C к кабелю C

## 2 КНОПКИ

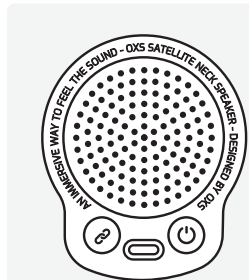

### 🔌 Питание

Нажмите и удерживайте в течение 3 с, чтобы включить или выключить питание устройства.

### 🔗 Ссылка

Нажмите эту кнопку, чтобы перейти к режиму установки соединения.

## 3 СВЕТОДИОДНЫЕ ИНДИКАТОРЫ



Медленно пульсирует белым  
Не подключено



Постоянно светится белым  
Подключено



Быстро мигает белым  
Переход к режиму установки соединения



Вкл. 1 с, выкл. 5 с  
Резервный режим



Пульсирует красным  
Низкий заряд аккумулятора



Постоянно светится красным  
Зарядка аккумулятора



Выкл. красный светодиодный индикатор  
Зарядка завершена

## 4 ПОДКЛЮЧЕНИЕ

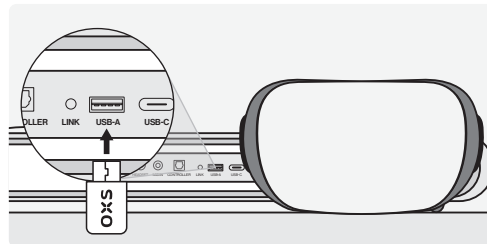

1. Вставьте ключ доступа USB-A в задней части устройства OXS Thunder Bar.

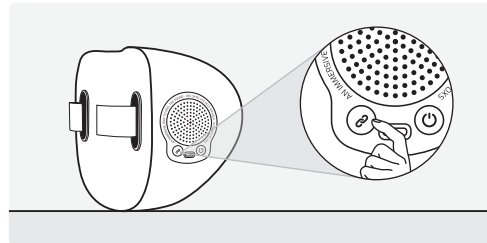

3. Нажмите и удерживайте кнопку СВЯЗЬ на устройстве Спутниковый шейный динамик OXS.

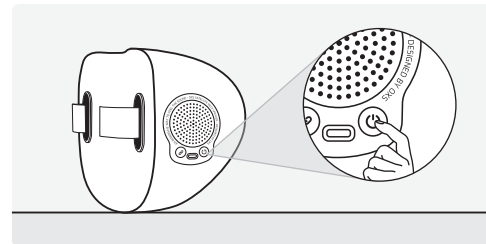

2. Подключите питание спутникового шейного динамика OXS.

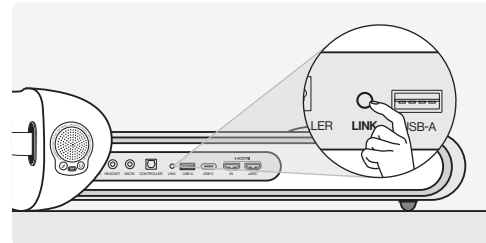

4. Нажмите и удерживайте кнопку LINK (СВЯЗЬ) в задней части устройства OXS Thunder Bar.

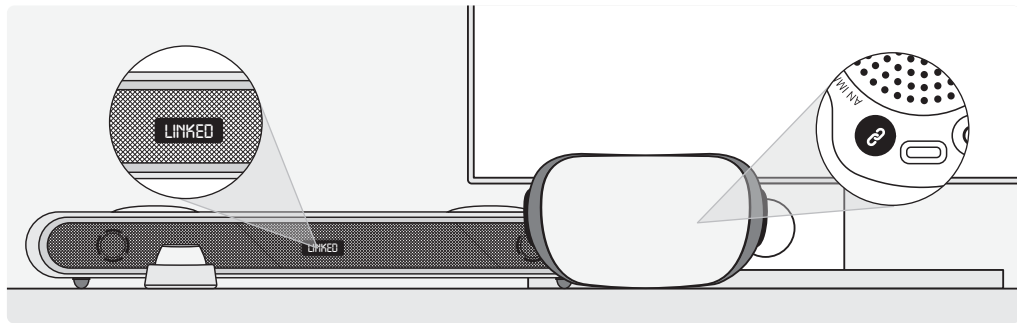

5. На экране дисплея на звуковой панели отобразится слово LINKED (СВЯЗАНО), при этом кнопка СВЯЗЬ на спутниковом шейном динамике будет постоянно светиться белым, указывая на надежное подключение.

## 5 РЕГУЛИРОВКА ГРОМКОСТИ

Вы можете регулировать громкость спутникового шейного динамика OXS в меню OXS Thunder Bar.

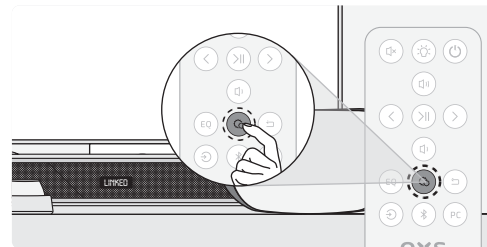

1. Нажмите кнопку настроек на пульте дистанционного управления устройством OXS Thunder Bar.

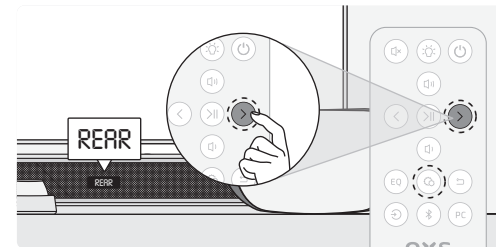

2. Нажмите >, чтобы выполнить навигацию меню до REAR (ЗАДНЕЙ ЧАСТИ).

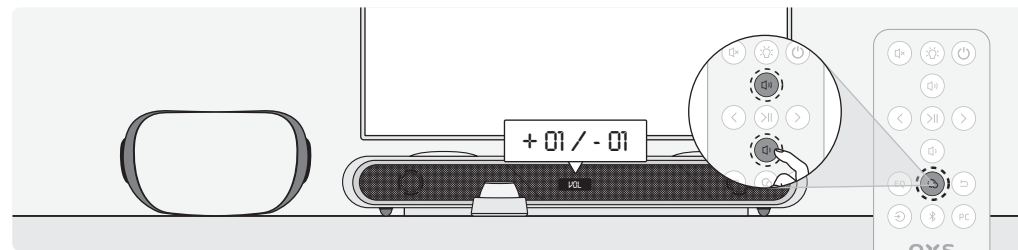

3. Нажимайте кнопки ГРОМК+ или ГРОМК-, чтобы регулировать громкость спутникового шейного динамика OXS.

## ⑥ ЗАРЯДКА

Заряжайте спутниковый шейный динамик OXS быстро и просто посредством кабеля USB-C к C, входящего в комплект поставки. Для более быстрой зарядки используйте совместимый адаптер быстрой зарядки.

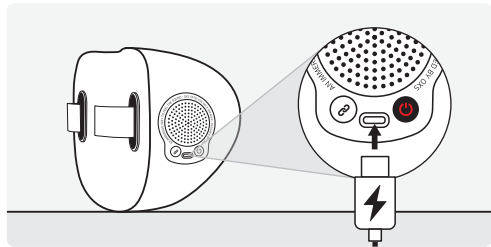

## ⑦ АВТОМАТИЧЕСКИЙ РЕЖИМ ОЖИДАНИЯ

Спутниковый шейный динамик автоматически выключается вместе со звуковой панелью (при шнуре, включенном в розетку электропитания), при этом, когда питание звуковой панели включается, также включается и питание спутникового шейного динамика.

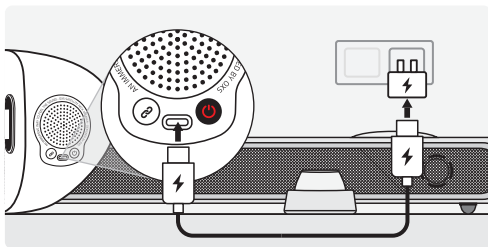

### Примечания:

**Работа в проводном режиме:** Для этой функции требуется, чтобы вилка шейного динамика была вставлена в адаптер.

**Беспроводное энергосбережение:** Шейный динамик выключается через 15 минут отсутствия активности при питании от аккумулятора.

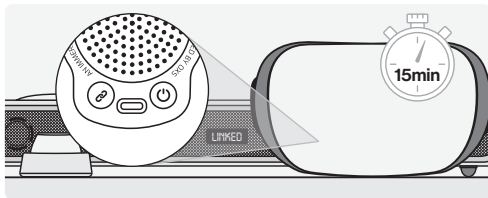

# 使用手册

# 07

## ① 包装内含

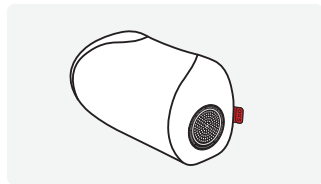

卫星颈枕音箱

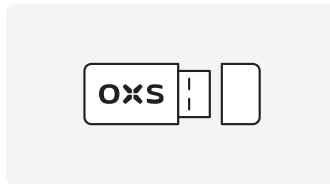

USB A 连接器

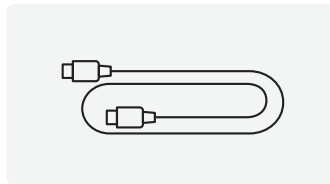

USB C 转 C 线

## ② 按键指示

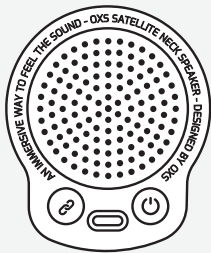

 开关

按住3秒开启或关闭设备。

 连接

按住3秒进入连接模式。

## ③ 灯光说明



白色缓慢闪烁  
未连接

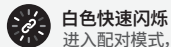

白色快速闪烁  
进入配对模式,  
等待连接



白色常亮  
已连接

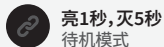

亮1秒, 灭5秒  
待机模式



红色缓慢闪烁  
低电量

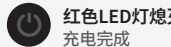

红色LED灯熄灭  
充电完成



红色常亮  
电池充电中

## ④ 连接

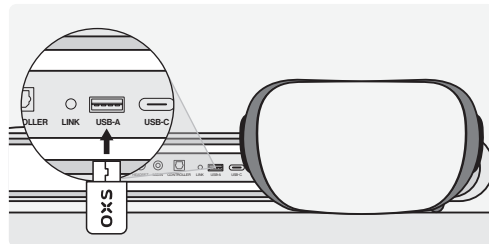

1. 将 USB-A 连接器插入您的 OXS Thunder Bar 后部。

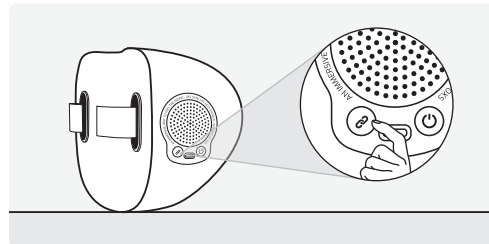

3. 按住 OXS 卫星颈枕音箱上的连接按钮。

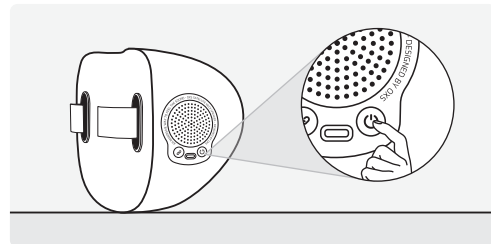

2. 打开 OXS 卫星颈枕音箱的电源。

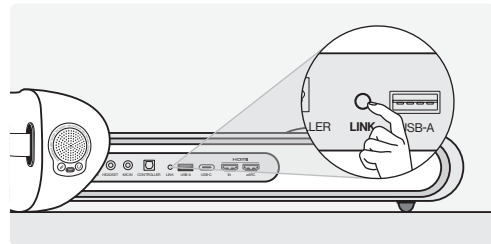

4. 按住 OXS Thunder Bar 后部的 LINK 按钮。

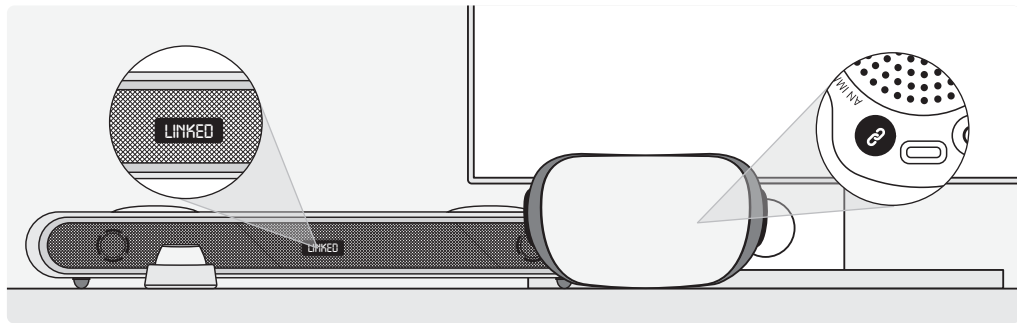

5. OXS Thunder Bar 的显示屏将显示 LINKED,同时卫星颈枕音箱的连接按钮显示常亮白灯,表明已连接。

## ⑤ 调整音量

您可以在 OXS Thunder Bar 的菜单中调整 OXS 卫星颈枕音箱的音量。

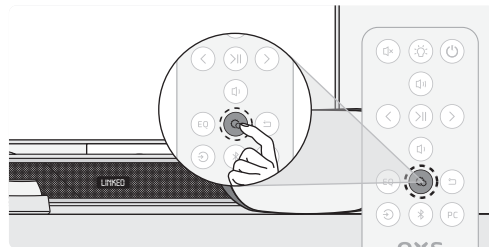

1. 在 OXS Thunder Bar 的遥控器上按下设置按钮。

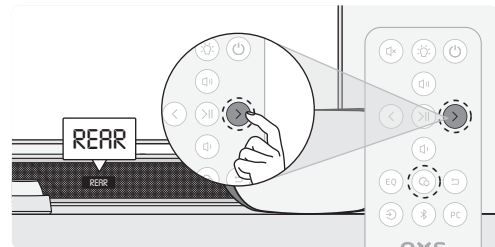

2. 按 > 键导航菜单到 REAR。

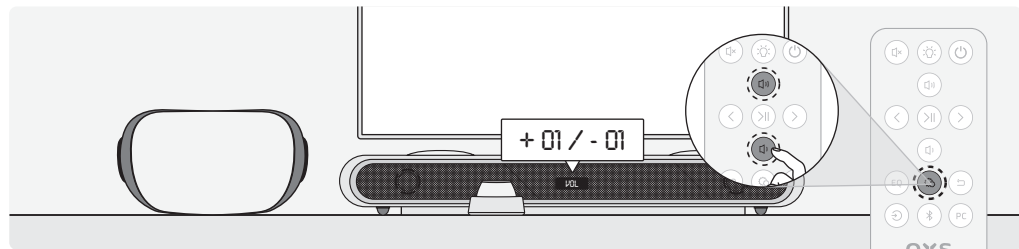

3. 按 VOL+ 或 VOL- 键调整 OXS 卫星颈枕音箱的音量。

## ⑥ 充电

您可以使用附带的 USB-C 转 C 线给 OXS 卫星颈枕音箱充电。

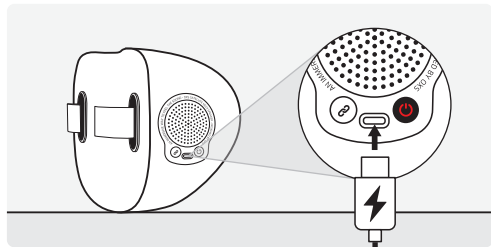

## ⑦ 自动待机

插电使用时, 卫星颈枕音箱会自动与 OXS Thunder Bar 同步待机或唤醒。

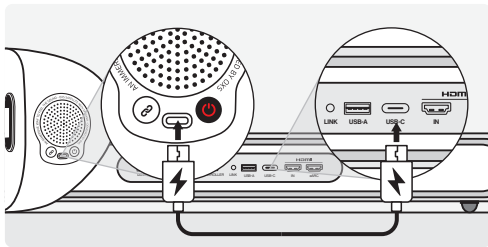

注:

有线操作: 该功能需要卫星颈枕音箱连接适配器方插电使用。

无线节电模式: 使用电池供电时, 卫星颈枕音箱会在15分钟无操作后自动关机。

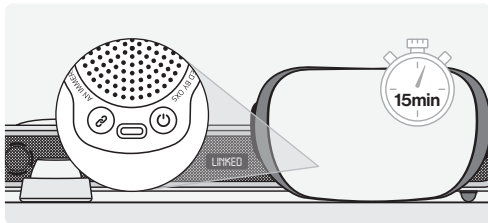

# 使用手冊

# 08

## ① 包裝內含

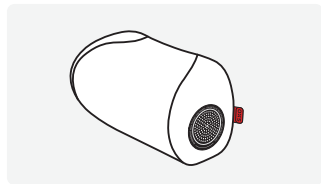

衛星頸枕音箱

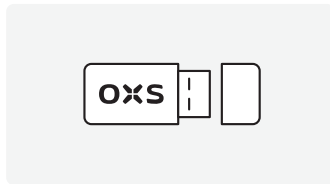

USB A 連接器

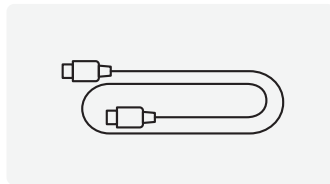

USB C 轉 C 線

## ② 按鍵指示

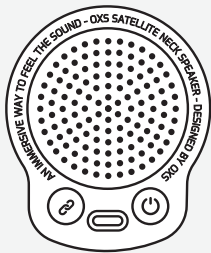

開關

按住3秒開啟或關閉設備。

連接

按住3秒進入連接模式。

## ③ 燈光指示



白色緩慢閃爍  
未連接



白色快速閃爍  
進入配對模式，  
等待連接



紅色緩慢閃爍  
低電量



紅色LED燈熄滅  
充電完成

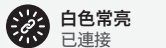

白色常亮  
已連接



亮1秒，滅5秒  
待機模式

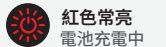

紅色常亮  
電池充電中

## ④ 連接

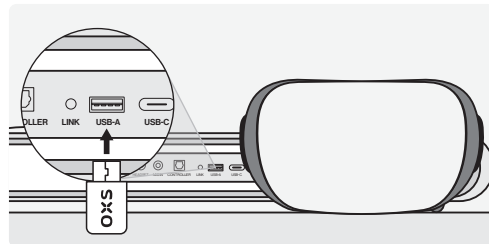

1. 將 USB-A 連接器插入您的 OXS Thunder Bar 后部。

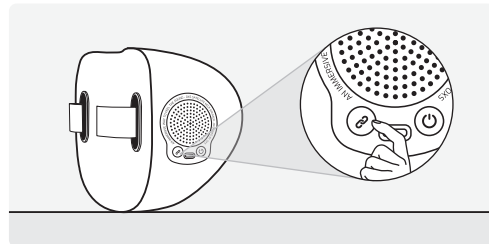

3. 按住 OXS 衛星頸枕音箱上的連接按鈕。

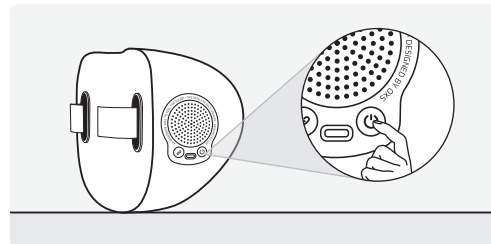

2. 打開 OXS 衛星頸枕音箱的電源。

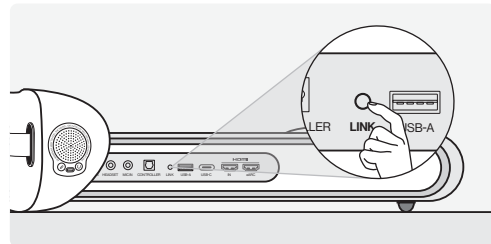

4. 按住 OXS Thunder Bar 后部的 LINK 按鈕。



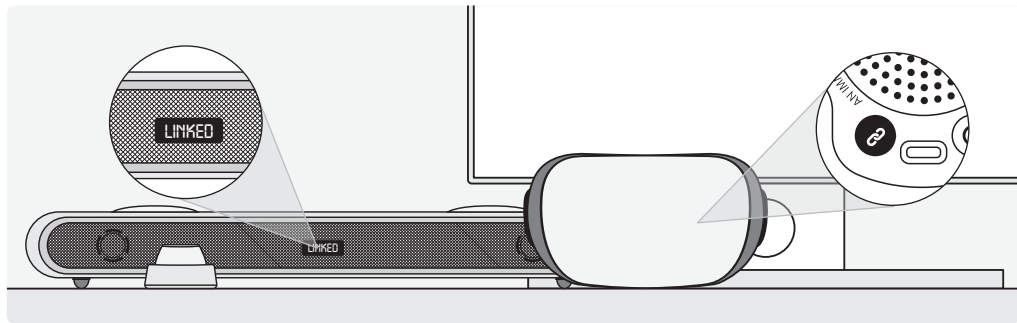

5. OXS Thunder Bar 的顯示屏將顯示 LINKED, 同時衛星頸枕音箱的連接按鈕顯示常亮白燈, 表明已連接。

## ⑤ 調整音量

您可以在 OXS Thunder Bar 的菜單中調整 OXS 衛星頸枕音箱的音量。

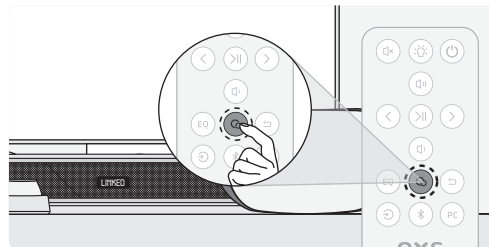

1. 在 OXS Thunder Bar 的遙控器上按下設置按鈕。

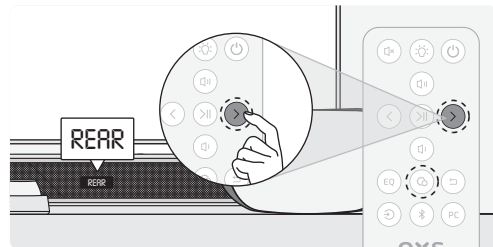

2. 按 > 鍵導航菜單到 REAR。

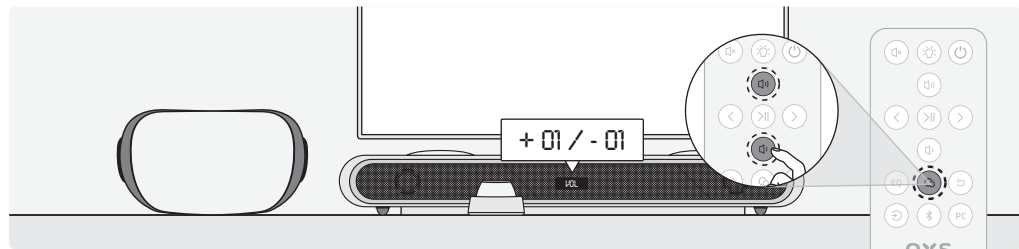

3. 按 VOL+ 或 VOL- 鍵調整 OXS 衛星頸枕音箱的音量。

## ⑥ 充電

您可以使用附帶的 USB-C 轉 C 線給 OXS 衛星頸掛式音箱充電。

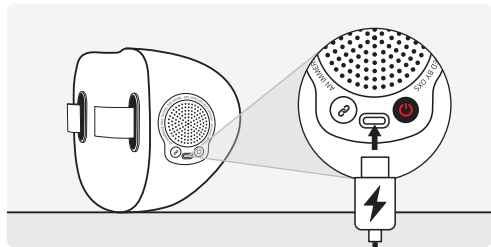

## ⑦ 自動待機

插電使用時，衛星頸枕音箱會自動與 OXS Thunder Bar 同步待機或喚醒。

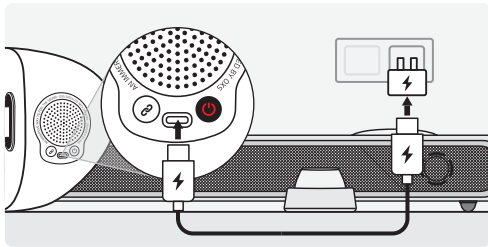

注：

有線操作：該功能需要衛星頸枕音箱連接適配器方插電使用。

無線節電模式：使用電池供電時，衛星頸枕音箱會在15分鐘無操作後自動關機。

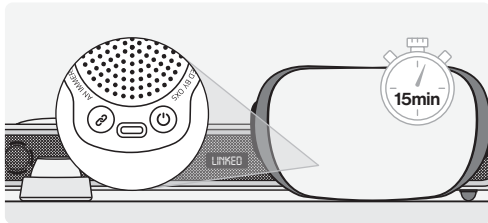

# ユーザーマニュアル

# 09

## ① セット内容

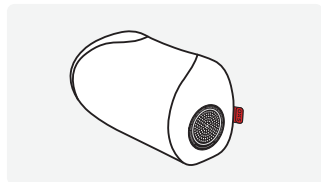

OXS サテライトネックスピーカー

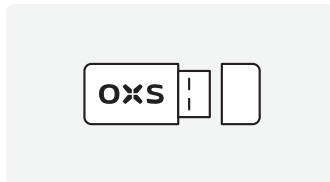

USB A ドングル

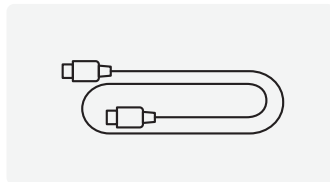

USB C - C ケーブル

## ② ボタン



### 電源

デバイスの電源を入れるか切るために、3秒間押し続けてください。

### リンク

接続モードに入るために、3秒間押し続けてください。

## ③ LED



白色がゆっくりと点滅  
接続されていません



定常白色  
接続済み



白色が速く点滅  
ペアリングモードに入り、  
接続を待っています



1秒間オン、5秒  
間オフ  
待機モード



赤色が点滅  
バッテリー残量が少ない



定常赤色  
バッテリー充電中



赤色LED消灯  
充電完了

## ④ 接続

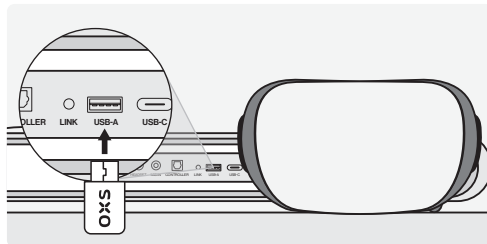

1. OXS Thunder Bar背面にUSB-Aドングルを差し込んでください。

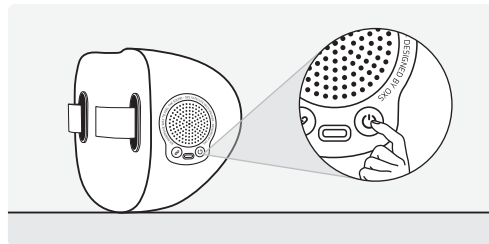

2. OXS サテライトネックスピーカーの電源を入れてください。

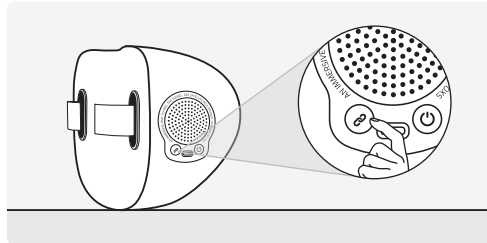

3. OXS サテライトネックスピーカーのリンクボタンを押して、そのまま保持してください。

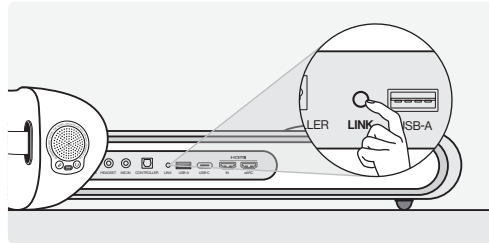

4. OXS Thunder Bar背面にあるLINKボタンを押して、そのまま保持してください。

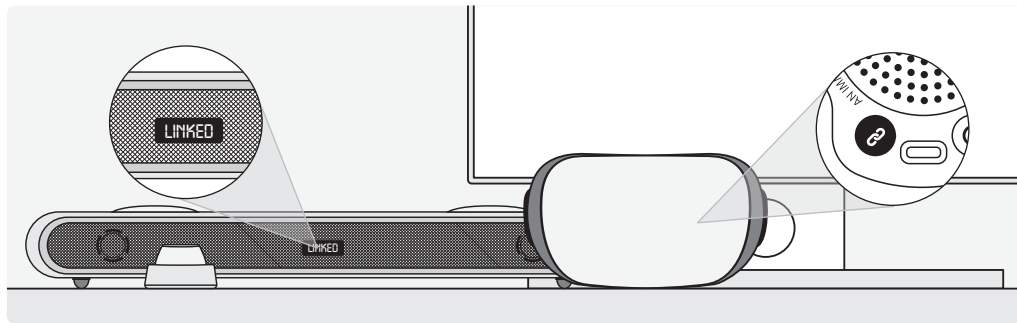

5. サウンドバーの表示画面には「LINKED」と表示され、サテライトネックスピーカーのリンクボタンには固定の白色が表示され、接続が確立されたことを示します。

## ⑤ 音量の調整

OXS Thunder BarメニューでOXS サテライトネックスピーカーの音量を調整できます。

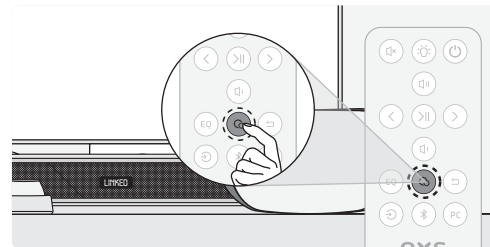

1. OXS Thunder Barリモコンにある設定ボタンを押してください。

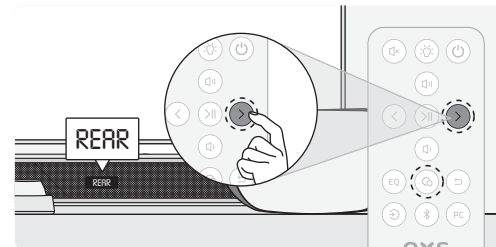

2. > ボタンを押してメニューでREAR(リア)に移動してください。

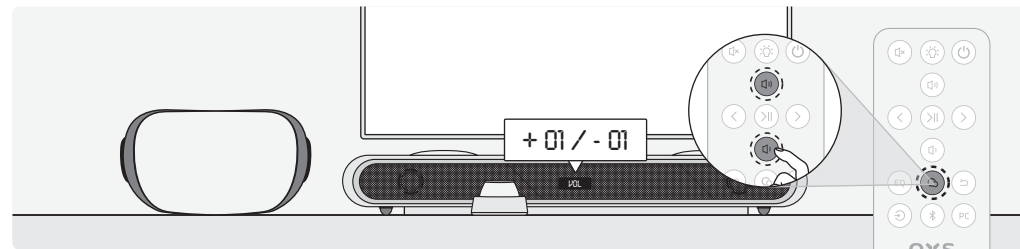

3. VOL+ または VOL- を押してOXS サテライトネックスピーカーの音量を調整してください。

## ⑥ 充電

同梱されているUSB-C to Cケーブルで、OXSサテライトネックスピーカーを迅速かつ簡単に充電できます。最速の充電のために、Quick Charge対応のアダプターを使用してください。

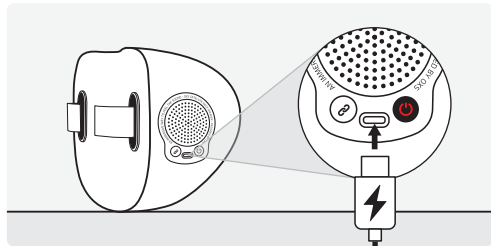

## ⑦ 自動スタンバイ

サテライトネックスピーカーは、サウンドバーに接続されているときに自動的にオフになり、サウンドバーがオンになると再びオンになります。

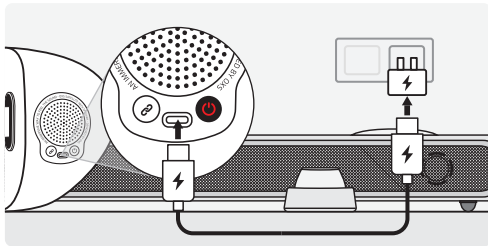

### 注意事項:

有線操作: この機能を使用するには、ネックスピーカーをアダプターに接続する必要があります。

無線省電力: ネックスピーカーは、バッテリー電源で15分間活動がない場合に自動的にオフになります。

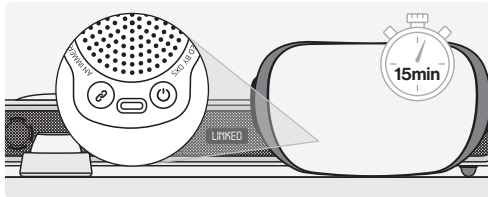

# 사용설명서

# 10

## ① 패킹 리스트

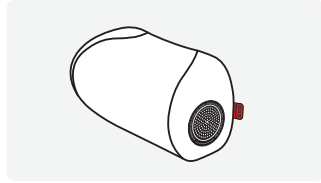

OXS 위성 넥 스피커

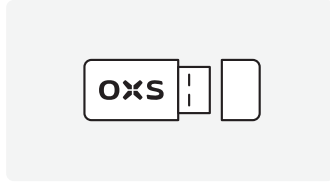

USB-A 동글

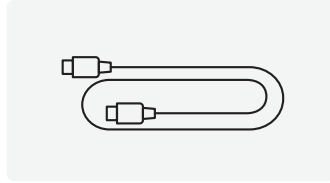

USB C - C 케이블

## ② 버튼



전원

전원을 켜거나 끄려면 3초간 누르고 있으세요.

연결

연결 모드로 들어가려면 3초간 누르고 있으세요.

## ③ LED

천천히 깜박이는 하얀색  
연결되지 않음

빠르게 깜박이는 하얀색  
페어링 모드 진입,  
연결 대기 중

고정된 하얀색  
연결됨

1초 켜짐, 5초 꺼짐  
대기 모드

붉게 깜박임  
배터리 부족

붉은 LED 꺼짐  
충전 완료

고정된 붉은색  
배터리 충전 중

## ④ 연결

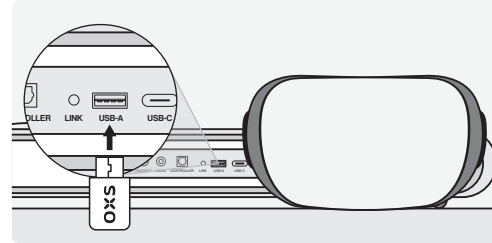

1. USB-A 동글을 OXS Thunder Bar 의 뒷면에 꽂으세요.

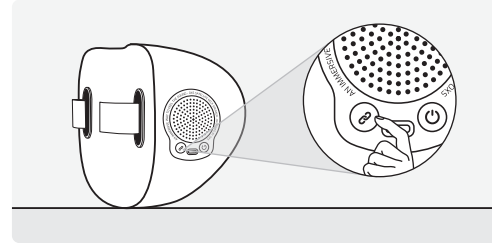

3. OXS 위성 넥 스피커에 있는 연결 버튼을 누르고 있으세요.

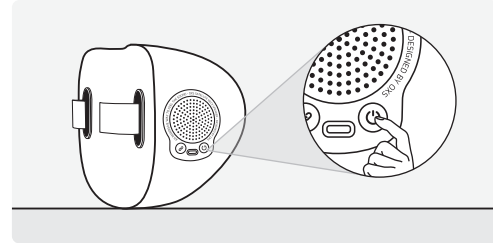

2. OXS 위성 넥 스피커를 켜세요.

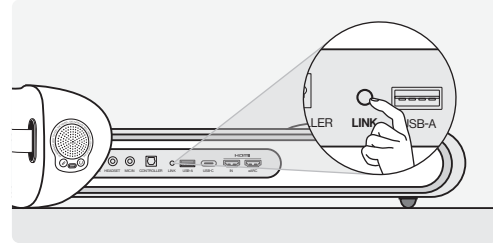

4. OXS Thunder Bar 뒷면에 있는 LINK 버튼을 누르고 있으세요.

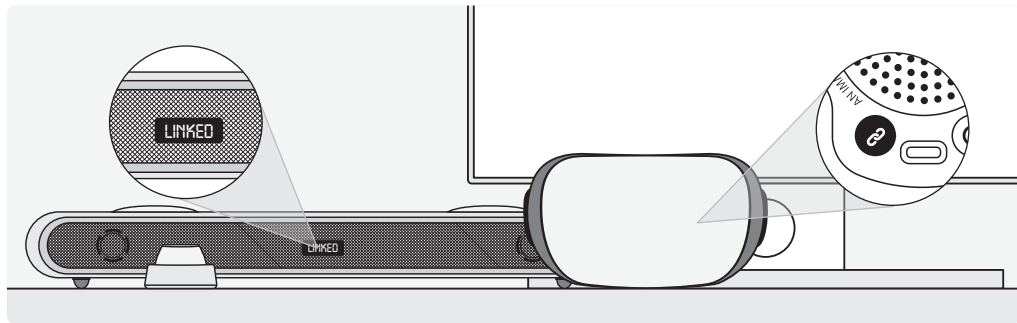

5. 사운드바의 디스플레이 화면에는 LINKED가 표시되고, 위성 넥 스피커의 연결 버튼에는 고정된 하얀색이 나타나 연결이 확실함을 나타냅니다.

## ⑤ 볼륨 조절하기

OXS Thunder Bar의 메뉴에서 OXS 위성 넥 스피커의 볼륨을 조절할 수 있습니다.

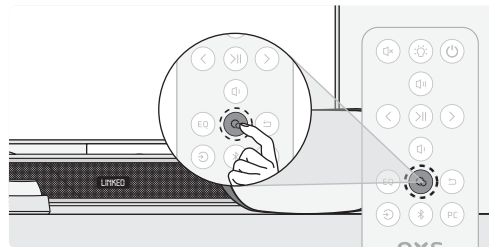

1. OXS Thunder Bar의 리모콘에 있는 설정 버튼을 누릅니다.

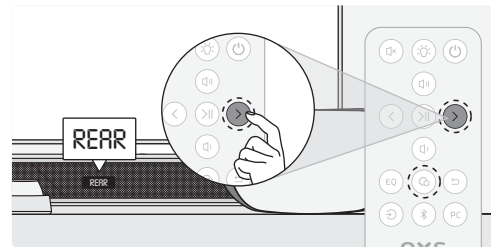

2. 메뉴에서 REAR로 이동하려면 > 버튼을 누릅니다.

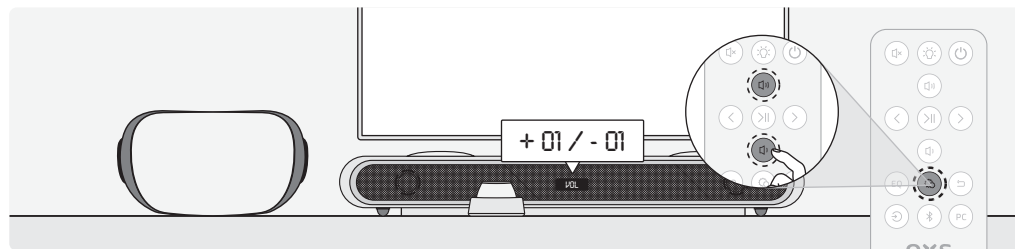

3. VOL+ 또는 VOL-를 눌러 OXS 위성 넥 스피커의 볼륨을 조절합니다.

## ⑥ 충전

포함된 USB-C to C 케이블을 사용하여 OXS 위성 넥 스피커를 빠르고 쉽게 충전하세요. 가장 빠른 충전을 위해서는 퀵차지(Quick Charge) 호환 어댑터를 사용하세요.

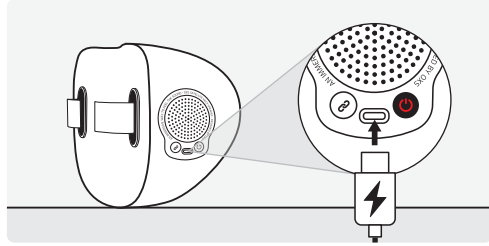

## ⑦ 자동 대기 모드

위성 넥 스피커는 사운드바와 연결되어 있을 때(플러그인 되어 있을 때) 사운드바가 꺼지면 자동으로 꺼지고 사운드바가 켜질 때 다시 켜집니다.

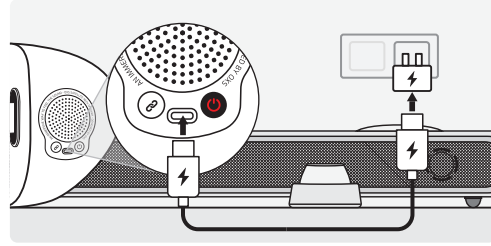

### 참고사항:

유선 작동: 이 기능은 넥 스피커가 어댑터에 연결되어 있을 때 필요합니다.  
무선 절전 모드: 배터리 전원을 사용할 때 15분간 활동이 없으면 넥 스피커가 꺼집니다.

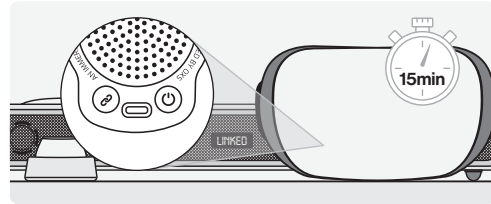

# دليل المستخدم

# 11



## 1 المحتويات

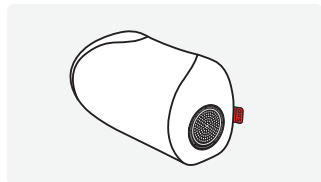

مكبر صوت عنق القمر الصناعي OXS

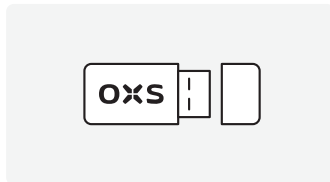

قرص USB A

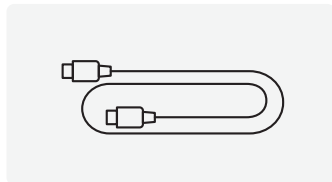

كابل USB C إلى C

## 4 التوصيل

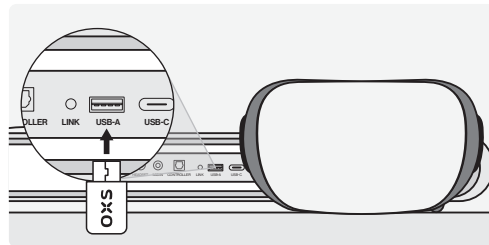

1. أدخل قرص USB-A في الجزء الخلفي من جهاز OXS Thunder Bar الخاص بك.

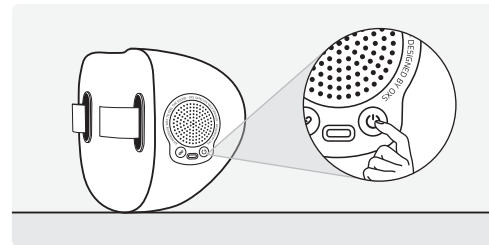

2. ابدأ تشغيل الطاقة في مكبر صوت عنق القمر الصناعي OXS.

## 2 الأزرار

## 3 المصابيح



### الطاقة

الضغط مطوياً لمدة 3 ثواني على الزر لتشغيل أو إيقاف تشغيل الوحدة.

### التوصيل

الضغط مطوياً لمدة 3 ثواني للدخول في وضع التوصيل.

إضاءة بيضاء ثابتة  
متصل

الإضاءة البيضاء  
تومض بسرعة  
وضع التشغيل 1  
ثانية، الإيقاف 5 ثانية  
وضع الاستعداد  
الدخول في وضع الاقتران،  
انتظر للتوصيل

إضاءة حمراء  
ثابتة  
شحن البطارية  
النض باللون  
الاحمر  
مستوى شحن البطارية

الضوء الأحمر ينطفئ سريعاً  
اكتمل الشحن

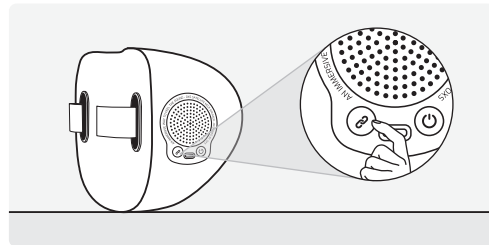

3. اضغط مطوياً على زر التوصيل LINK في مكبر صوت عنق القمر الصناعي OXS.

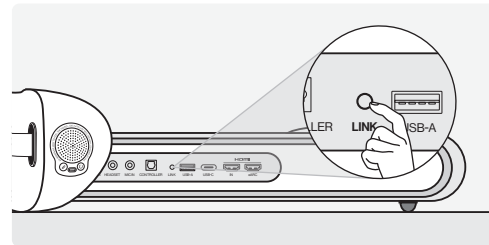

4. اضغط مطوياً على زر التوصيل LINK في OXS Thunder Bar.

## 5 ضبط الصوت

يمكنك ضبط الصوت في مكبر صوت عنق القمر الصناعي OXS في قائمة وحدة OXS Thunder Bar.

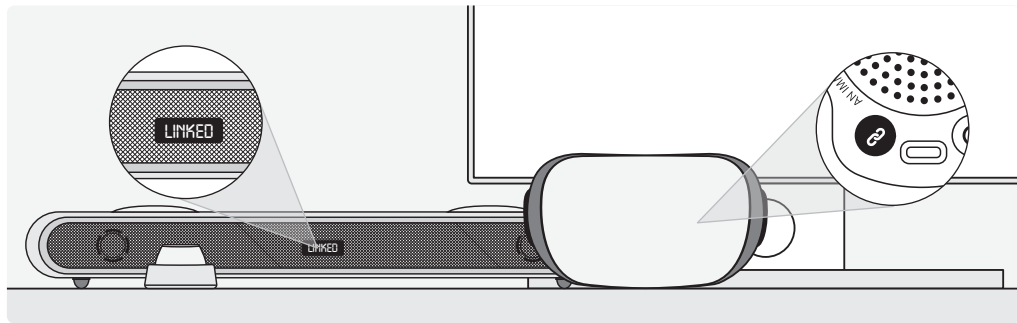

5. ستظهر كلمة متصل LINKED على شاشة العرض في وحدة مكبر الصوت، وسيظهر زر التوصيل LINK بلون أبيض ثابت على مكبر صوت عنق القمر الصناعي وهو ما يعني وجود اتصال ثابت.

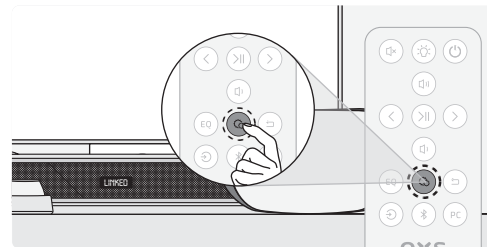

1. اضغط على زر الإعدادات على جهاز التحكم عن بعد الخاص ب OXS Thunder Bar.

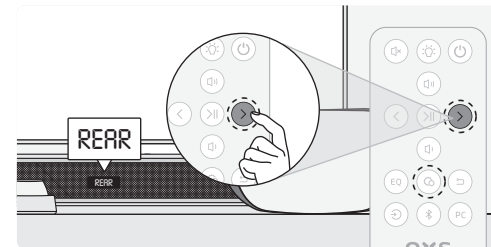

2. اضغط على < للانتقال من القائمة إلى REAR (الخلف).

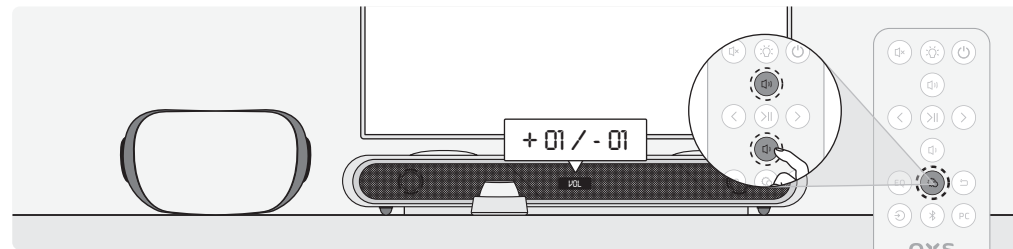

3. اضغط +VOL أو -VOL لضبط الصوت في مكبر صوت عنق القمر الصناعي OXS.

## ⑥ الشحن

يمكنك شحن مكبر صوت عنق القمر الصناعي OXS بسرعة وسهولة باستخدام كابل USB-C إلى C المرفق. للشحن السريع، استخدم وحدة شحن متوافقة مع الشحن السريع.

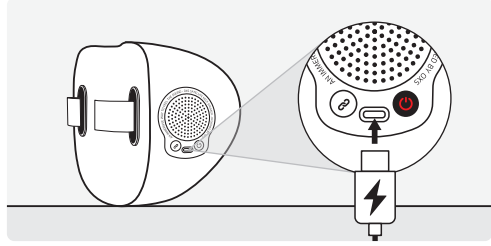

## ⑦ الوضع الاحتياطي التلقائي

يتم إيقاف تشغيل مكبر صوت عنق القمر الصناعي تلقائياً باستخدام مكبر الصوت (عند توصيله) ويتم تشغيله مرة أخرى عند تشغيل مكبر الصوت. ملاحظات:

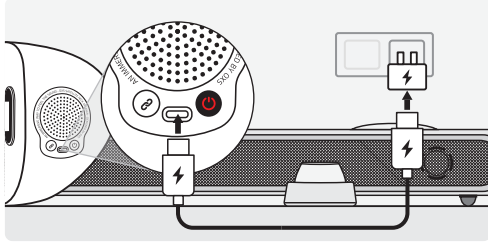

### التشغيل:

السلكي: تحتاج هذه الميزة إلى توصيل وحدة مكبر صوت الرقبة بمواءم. حفظ الطاقة لاسلكياً: تدخل وحدة مكبر صوت الرقبة وضع إيقاف التشغيل بعد 15 دقيقة من عدم نشاط الطاقة من البطارية.

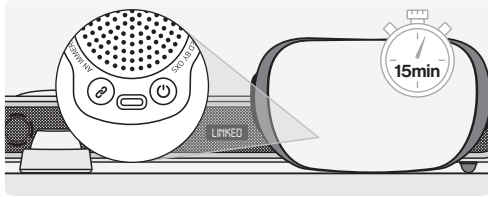

# Kullanım kılavuzu

# 12

## 1 İÇİNDE NE VAR

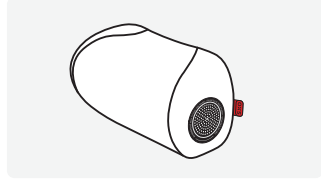

OXS Uydu Boyun Hoparlörü



Dongle USB Bağlantısı

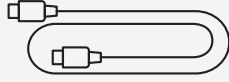

USB C - USB C Kablosu

## 2 TUŞLAR



**Güç**

Cihazı açmak ya da kapatmak için basın & 3 s basılı tutun.

**Bağla**

Bağlantı moduna girmek için basın & 3 s basılı tutun.

## 3 LED'LER



**Beyaz Yavaş Yanıp Sönüyor**  
Bağlı değil



**Beyaz Hızlı Yanıp Sönüyor**  
Eşleşme moduna girdi, bağlantı bekleniyor



**Kırmızı Yavaş Yanıp Sönüyor**  
Düşük batarya



**Kırmızı LED Devre Dışı**  
Şarj Tamamlandı



**Daima Açık Beyaz Bağlı**



**1 s Açık, 5 s Kapalı**  
Bekleme modu



**Daima Açık Kırmızı**  
Batarya şarj oluyor

## 4 BAĞLANTI

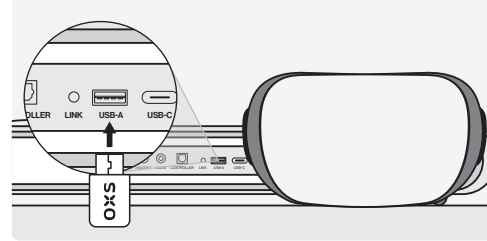

1. OXS Thunder Bar'ınızın arkasına USB-A dongle takın.

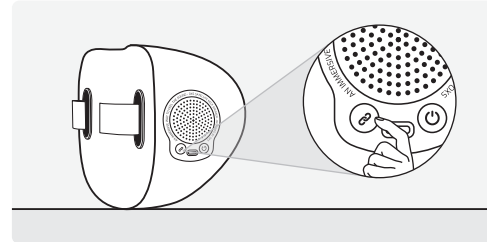

3. OXS Uydu Boyun hoparlör üzerindeki BAĞLA tuşuna basın ve basılı tutun.

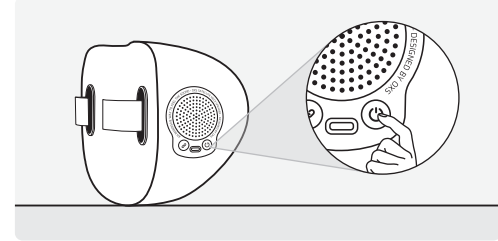

2. OXS Uydu Boyun Hoparlörünü açın.

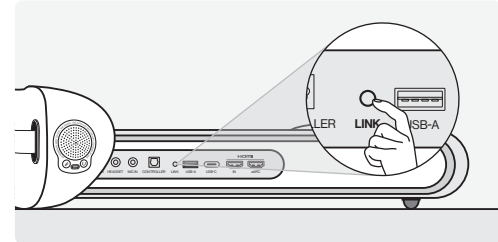

4. OXS Thunder Bar'ınızın arkasındaki BAĞLA tuşuna basın ve basılı tutun.

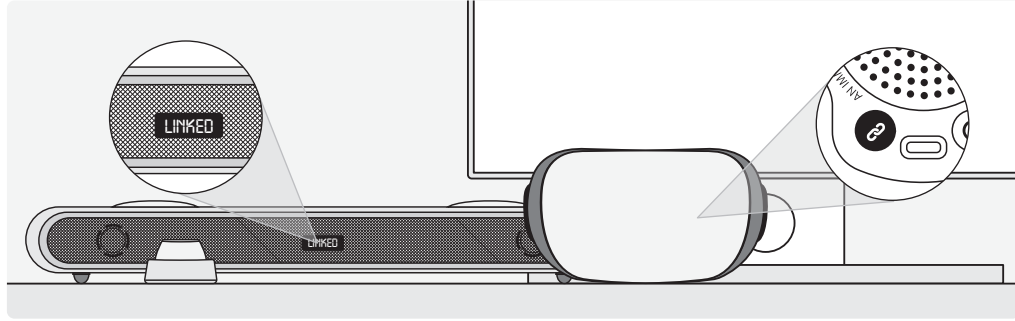

5. Ses barının görüntü ekranı BAĞLANDI görülecek, daima açık bağlantı olduğunu gösteren Uydu Boyun Hoparlörünün BAĞLA tuşu üzerinde daima açık beyaz ışık yanacaktır.

## 5 SES SEVİYESİNİN AYARLANMASI

OXS Thunder Bar menüsündeki OXS Uydu Boyun Hoparlörü üzerinden ses seviyesini ayarlayabilirsiniz.

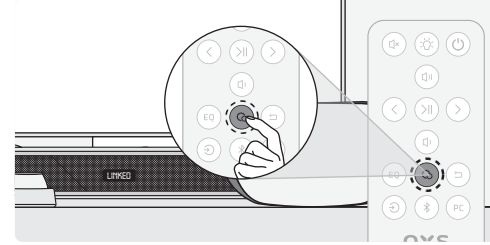

1. OXS Thunder Bar'ın uzaktan kumandasındaki ayarlar tuşuna basın.

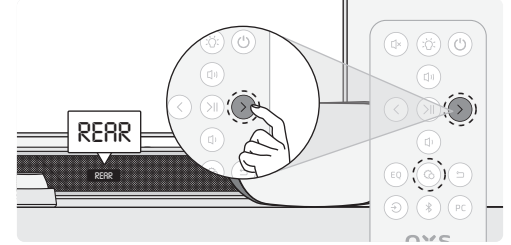

2. Menüye REAR konumuna götürmek için > tuşuna basın.

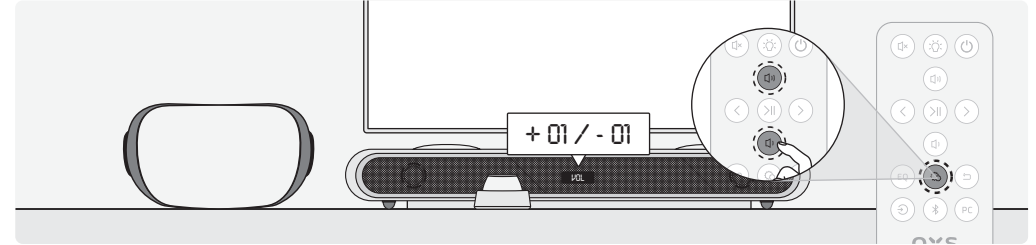

3. OXS Uydu Boyun Hoparlörünün ses seviyesini ayarlamak için VOL+ ya da VOL- tuşlarına basın.

## 6 ŞARJ

OXS Uydü Boyun Hoparlörünü tedarik edilen USB-C – USB-C kablosuyla hızlıca ve kolaylıkla şarj edin. En hızlı şarj işlemi için Hızlı Şarj uyumlu adaptör kullanın.

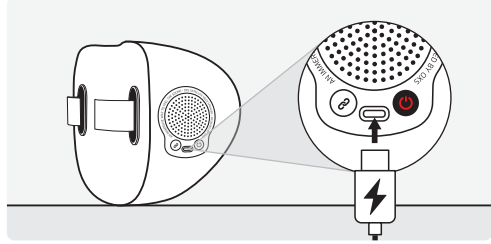

## 7 OTOMATİK BEKLEMEDE

Uydü boyun hoparlörü, ses barı ile (takıldığında) otomatik olarak kapanır ve ses barı çıkarıldığında güç geri gelir.

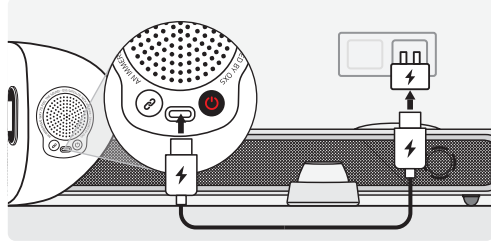

### Notlar:

**Kablolu İşlem:** Bu özellik için boyun hoparlörünün bir adaptöre takılması gerekir.

**Kablosuz Güç Tasarrufu:** Boyun hoparlörü batarya gücü 15 dakika hareketsiz kaldığında kapanır.

