

# USER MANUAL



## Hybrid Inverter

R6KH3 / R8KH3 / R10KH3 / R12KH3 / R15KH3



---

## DECLARATION

SHENZHEN MEGAREVO TECHNOLOGY CO., LTD. ( hereinafter "MEGAREVO" ) reserves the right to modify the frame dimensions, functionality, technical data, parameters, standards without prior notice.

The contents of this manual have been checked for accordance with its described hardware and software. However, the contents of this manual may be subject to appropriate modification as a result of product upgrade, specification change and update of the manual, we cannot guarantee full accordance all the time. But the data in this manual are reviewed regularly and any necessary corrections are included in subsequent editions. Suggestions for improvement from readers are appreciated.

No part of this manual may be reproduced in any form, or by any means, without prior written permission of Megarevo.

All rights © SHENZHEN MEGAREVO TECHNOLOGY CO., LTD.

---

## OTHER RIGHTS

 and other MEGAREVO trademarks used in this manual are owned by MEGAREVO.

Using data contained in firmware or software developed by MEGAREVO, in part or in full, for commercial purposes by any means is prohibited.

Reverse engineering, cracking or any other operation that destroys the original programming design of software developed by MEGAREVO is prohibited.

---

## PREFACE

Thank you for choosing **REVO Series Hybrid Inverter** ( hereinafter "inverter" ) .

This user manual presents a detailed description of REVO series with respect to product features, structural characteristics, functions, installation, parameter settings, troubleshooting, commissioning and daily maintenance, etc. Be sure to carefully read through the safety precautions before use and keep it properly at a place for easy access.



### IMPORTANT NOTES

---

- Please assure the intactness of product enclosure and all safety covers before installation. Operation must conform to the requirements of this manual and local industrial safety regulations and/or electrical codes.
- In the event of damage or loss of user manual, users may ask local distributors, offices or our Technical Service Department for a new one.
- Contents of this manual may be subject to appropriate modification as a result of product upgrade, specification change and update of the manual.
- If any item as stated in this manual is not clear, please contact our Technical Service Department.
- If any anomaly occurs after power up or during the operation, it is essential to stop the machine and identify the fault or seek technical services as soon as possible.

This manual is valid for the following model of hybrid inverters:

- R6KH3
- R8KH3
- R10KH3
- R12KH3
- R15KH3

It will be referred to as "inverter" hereinafter unless otherwise specified.

The inverter must only be installed by professional technicians. The professional technician is required to meet requirements as follows:

- Know electronic, electrical wiring and mechanical expertise, and be familiar with electrical and mechanical schematics.
- Be familiar with local standards and relevant safety regulations of electrical systems.
- Have received professional training related to the electrical equipment installation and commissioning.
- Be able to quickly respond to hazards or emergencies that occur during installation and commissioning.

---

## TECHNICAL SUPPORT

Before installation, wiring, operation, and repair to the inverter, please read carefully and strictly comply with all its Safety Precautions in this manual.

Please ensure all the warning marks on the inverter are clear and distinct. Replace or add the obscure or missed warning marks.

---

The information from following sources is all effective.

**Scan the QR code for the latest information and services:**



WhatsApp

**Service time:** 24/7

---

Users may acquire general technical data and information through MEGAREVO official website: <http://www.megarevo.com>

If you have any question, or anything that it is not clear for you, or have some troubles during installation, wiring, and/or operation, you are suggested to contact MEGAREVO via its recommended contact information in this manual or contact its sales representatives or service engineers.

# Content

<b>1 Safety Precautions</b>	001
1.1 Important Safety Instructions	001
1.2 Important Safety Instructions	008
1.3 CE Directives	009
<b>2 Introduction</b>	011
2.1 Model Description	011
2.2 Basic features	011
2.3 Work Modes	014
2.4 Dimensions	018
2.5 Terminals	019
2.6 Parameters	021
<b>3 Installation</b>	026
3.1 Check for Physical Damage	026
3.2 Packing List	026
3.3 Mounting	027
<b>4 Electrical Connection</b>	031
4.1 PV connection	031
4.2 Grid connection	033
4.3 EPS Connection (apply to I Version and E Version only)	035
4.4 Battery Connection	042
4.5 CT Connection and Phase instruction	045
4.6 DRM Connection (Function temporarily retained)	046
4.7 WiFi Connection (optional)	048
4.8 GPRS Connection (optional)	049
4.9 Inverter Manipulation	050
<b>5 Setting</b>	052

5.1 Control Panel	052
5.2 Instructions for LED Indicator	052
5.3 Instructions for the use of three modes	053
<b>6 LCD Operation</b>	<b>056</b>
6.1 LCD Interface	056
6.2 Setting	060
6.3 Inquire	071
6.4 Statistic	072
<b>7 Fault Diagnosis and Solutions</b>	<b>073</b>



## Figure

---

Figure 2-1	Symbols on the Product	011
Figure 2-2	E-Version system diagram	012
Figure 2-3	I-Version system diagram	013
Figure 2-4	Dimensions	018
Figure 2-5	Terminals	019
Figure 3-1	Space Requirement	028
Figure 4-1	E-Version system diagram	037
Figure 4-2	I-Version system diagram	038
Figure 4-3	Battery connection	043
Figure 4-4	BMS PIN definition	043
Figure 4-5	CT connection and phase wiring diagram	045
Figure 4-6	DRM PIN definition	047
Figure 4-7	WIFI connection diagram	048
Figure 4-8	GPRS connection diagram	049
Figure 5-1	Control panel	052

## Table

---

Table 1-1	Symbols on the Product	008
Table 2-1	Terminals	020
Table 2-2	Parameters	021
Table 2-3	Parts list	026
Table 4-1	Max. DC Voltage Limitation	031
Table 4-2	Recommended cables and micro-breakers	033

Table 4-3	Recommended cables and micro-breakers	039
Table 4-4	Common feasible loads for reference	041
Table 4-5	Recommended non-polar DC breakers	042

## History

Version	Release Date	Description
V1.00	Jan. 2021	First edition
V2.10	Jan. 2023	Update
V2.20	Apr. 2023	Update

# 1 Safety Precautions

Safety signs in this manual:

---



**DANGER** indicates high-risk potential hazards that, if not avoided, may lead to death or serious injury.



**WARNING** indicates moderate-risk potential hazards that, if not avoided, may lead to death or serious injury.



**CAUTION** indicates low-risk potential hazards that, if not avoided, may lead to minor or moderate injury.



**NOTE** provides valuable tips on the best operation of our products.

---

## 1.1 Important Safety Instructions

---



Danger to life due to a high voltage inside the inverter!

- All work must be performed by a qualified electrician.
  - Children and persons with reduced physical sensory abilities, mental capabilities, or lack of experience and knowledge should not use this equipment unless supervised or instructed.
-



CAUTION

---

### Danger of burns

- When the product is working, the upper of the enclosure and the enclosure body may become hot.
  - During operation, only the touch screen needs to be operated.
- 
- 



CAUTION

---

### Radiation may cause damage to health.

- Do not stay at a place less than 20cm away from the inverter for a long time.
- 
- 



---

### Ground the PV generator.

- Comply with the local requirements for grounding the PV modules and the PV generator.
  - It is recommended that generator frames and other conductive surfaces be connected in a manner that ensures continuous conduction and grounding for optimum protection of the system and personnel.
- 
- 



WARNING

---

Make sure the input DC voltage is less than the maximum value. Over-voltage may cause permanent damage to the inverter or other losses, which will not be covered by the warranty!

---

---



WARNING

---

Before attempting any maintenance, cleaning or working on any circuits connected to inverter, authorized service personnel must disconnect both AC and DC power from inverter.

---

---



---

Do not operate the inverter while the equipment is running.

---

---



Risk of electric shock!

---

- It is recommended to use only accessories that are compatible with the inverter, otherwise it may lead to the risk of fire, electric shock or personal injury.
- Make sure the existing wiring is in good condition, and the wires are not undersized.
- Do not disassemble any parts of inverter which are not mentioned in installation guide. It contains no user-serviceable parts. See Warranty for service. Unauthorized repairs may result in a risk of electric shock or fire and will void your warranty, and will void the warranty.
- Keep away from flammable, explosive materials to avoid fire disaster.
- The installation location should be away from humid or corrosive substance.
- Authorized service personnel must use insulated tools when installing or working with this equipment.
- PV modules should have IEC 61730 Class A rating.
- Do not touch either the positive or negative pole of PV connecting device. Strictly prohibit touching both of them at the same time.
- The unit contains capacitors that remain charged to a potentially lethal voltage when the MAINS , battery and PV supply has been disconnected.
- Hazardous voltages may remain present for up to 5 minutes after disconnection.

- CAUTION-The energy stored in the capacitor is a shock hazard, do not operate the inverter, coupler, power cable, battery cable, PV cable or PV generator while energized. After turning off the PV, battery and power supply, always wait 5 minutes to allow the intermediate circuit capacitors to discharge before unplugging the DC, battery and power coupler.
- When accessing the internal circuit of inverter, it is very important to wait 5 minutes before operating the power circuit or demounting the electrolyte capacitors inside the device. Do not open the device beforehand since the capacitors require time sufficiently discharge!
- Measure the voltage between terminals  $U_{DC+}$  and  $U_{DC-}$  with a multi-meter (impedance at least 1Mohm) to ensure that the device is discharged ( <35VDC ) before starting to work inside the device.

### 1.1.1 Install surge protection devices (SPDs) for PV

---



- Over-voltage protection with surge arresters should be provided when installing PV power generation system.
  - The grid connected inverter does not have SPDs installed on both PV input side and MAINS side.
- 
- Lightning will cause a damage either from a direct strike or from surges due to a nearby strike.
  - Induced surges are the most likely cause of lightning damage in majority of installations, especially in rural areas where electricity is usually provided by long overhead lines. Surge may be included on both the PV array conduction and the AC cables leading to the building.
  - Specialists in lightning protection should be consulted during the end

use application.

- Using appropriate external lightning protection, the effect of a direct lightning strike into a building can be mitigated in a controlled way, and the lightning current can be discharged into the ground.
- Installation of SPDs to protect the inverter against mechanical damage and excessive stress include a surge arrester in case of a building with external lightning protection system (LPS) when separation distance is kept.
- To protect the DC system, surge suppression device (SPD type2) should be fitted at the inverter end of the DC cabling and at the array located between the inverter and the PV generator, if the voltage protection level (VP) of the surge arresters is greater than 1100V, an additional SPD type 3 required for surge protection for electrical devices.
- To protect the AC system, surge suppression devices (SPD type2) should be fitted at the main incoming point of AC supply (at the consumer's cutout), located between the inverter and the meter/distribution system; SPD (test impulse D1) for signal in according I to EN 61632-1.
- All DC cables should be installed to provide as short a run as possible, and positive and negative cables of the string or main DC supply should be bundled together. Avoiding the creation of loops in the system.
- Spark gap devices are not suitable to be used in DC circuits once conducting, they won't stop conducting until the voltage across their terminals is typically more than 30 volts.

### 1.1.2 Anti-Islanding Effect

The islanding effect is a special phenomenon where a grid-connected PV system still delivers power to the nearby grid when voltage losses occur in the power system. This can be dangerous for maintenance personnel and



the public. The Revo series inverters offer Active Frequency Drift (AFD) to prevent the islanding effect.

### 1.1.3 PE Connection and Leakage Current

- The end-use application shall monitor the protective conductor by residual current operated protective device (RCD) with rated fault current  $I_{fn} \leq 240\text{mA}$  which automatically disconnects the device in case of a fault. The device is intended to connect to a PV generator with a capacitance limit of about 700nf.



---

High leakage current!

Earth connection essential before connecting supply.

---

- Incorrect grounding can cause physical injury, death or equipment malfunction and increase electromagnetic.
- Make sure that grounding conductor is adequately sized as required by safety regulations.
- Do not connect the ground terminals of the unit in series in case of a multiple installation. This product can cause current with a DC component, Where a residual current operated protective (RCD) or monitoring (RCM) device is used for protection in case of direct or indirect contact, only an RCD or RCM of type B is allowed on the supply side of this product.

### 1.1.4 For United Kingdom

- The installation that connects the equipment to the supply terminals shall comply with the requirements of BS 7671.

- Electrical installation of PV system shall comply with requirements of BS 7671 and IEC 60364-7-712.
- No protection settings can be altered.
- User shall ensure that equipment is so installed, designed and operated to maintain at all times compliance with the requirements of ESQCR22(1)(a).
- Make sure that grounding conductor is adequately sized as required by safety regulations.
- Do not connect the ground terminals of the unit in series in case of a multiple installation. This product can cause current with a DC component, Where a residual current operated protective (RCD) or monitoring (RCM) device is used for protection in case of direct or indirect contact, only an RCD or RCM of type B is allowed on the supply side of this product.

### 1.1.5 For Australia and New Zealand

Electrical installation and maintenance shall be conducted by licensed electrician and shall comply with Australia National Wiring Rules.

### 1.1.6 Battery Safety Instructions

Revo hybrid Series inverter should be worked with high voltage battery, for the specific parameters such as battery type, nominal voltage and nominal capacity etc., please refer to section 4.

As accumulator batteries may contain potential electric shock and short-circuit current danger, to avoid accidents that might be thus resulted, the following warnings should be observed during battery replacement:







- 1: Do not wear watches, rings or similar metallic items.
- 2: Use insulated tools.
- 3: Put on rubber shoes and gloves.
- 4: Do not place metallic tools and similar metallic parts on the batteries.
- 5: Switch off load connected to the batteries before dismantling battery connection terminals.





6: Only personal with proper expertise can carry out the maintenance of accumulator batteries.

## 1.2 Important Safety Instructions

This section gives an explanation of all the symbols shown on the inverter and on the type label.

Table 1-1 Symbols on the Product

Symbol	Explanation
	CE mark. The inverter complies with the requirements of the applicable CE
	TUV
	RCM remark
	SAA certification
	Beware of hot surface. The inverter can become hot during operation. Avoid contact during operation.
	Danger to life due to high voltages in the inverter!
	Danger. Risk of electric shock!
	Please note the provisions of the instruction manual.

Symbol	Explanation
	The inverter can't be disposed together with the household waste. Disposal information can be found in the enclosed documentation.
	Do not operate inverter until it is isolated from battery, mains and on-site PV generation suppliers.
 	Danger to life due to high voltage. There is residual voltage existing in the inverter after powering off. Which needs 5 min to discharge. Wait 5 min before you open the upper lid or the DC lid.

### 1.3 CE Directives

This chapter follows the requirements of the European Low Voltage Directive, which contains safety instructions and conditions of acceptance for imported systems that you must follow when installing, operating and servicing the equipment. If ignored, it may result in personal injury or death, or damage to the equipment. Please read this before you perform work on the equipment. If you cannot understand these hazards, warnings, cautions, or instructions, contact an authorized service dealer to operate and maintain the equipment prior to installation.

The grid-connected inverter meets the requirements of IEC 62109-1/-2; IEC 62477-1; IEC 61000-6-1/-3.

If installed in a PV system, it is forbidden to start the unit (i.e. to start the specified operation) until it has been established that the entire system complies with the requirements specified in the CE Directive), that the grid-connected inverter is shipped with the connection device completed and ready for connection to the mains and PV power supply, and that the unit is installed in compliance with the national wiring regulations. Compliance

with safety regulations depends on proper installation and configuration of the system, including the use of the specified wiring.

The system must be installed only by professional assemblers who are familiar with safety and EMC requirements. It is the responsibility of the assembler to ensure that the final system complies with all relevant laws of the country of use.

The individual subassemblies of the system should be interconnected by national/international such as the wiring methods listed in the National Electrical Code (NFPA) Regulation No. 70 or VDE Regulation 0107.

## 2 Introduction

### 2.1 Model Description

The model description is as follows (take R8KH3 as an example):

Figure 2-1 Symbols on the Product

**R 8 K H 3**



R: REVO series	①
8K: output power, 8kW	②
H: battery high voltage	③
3: three-phase output	④

### 2.2 Basic features

Revo Hybrid Series is a high performance inverter that converts solar energy to DC power and stores the energy in batteries.

The inverter can be used to optimize its own energy consumption, to store energy in batteries for future use or to connect to the public grid. The mode of operation depends on the PV energy source and user preferences. It can use the energy from the batteries and the inverter (generated by the PV) to provide emergency power in case of grid outages.

Revo Hybrid Series is designed in two EPS versions for customers to choose from based on local rules.

E-Version applies to wiring rules that require the N (neutral) wire of the EPS to be disconnected from the N (neutral) wire of the grid (applicable to most countries).

Figure 2-2 E-Version system diagram

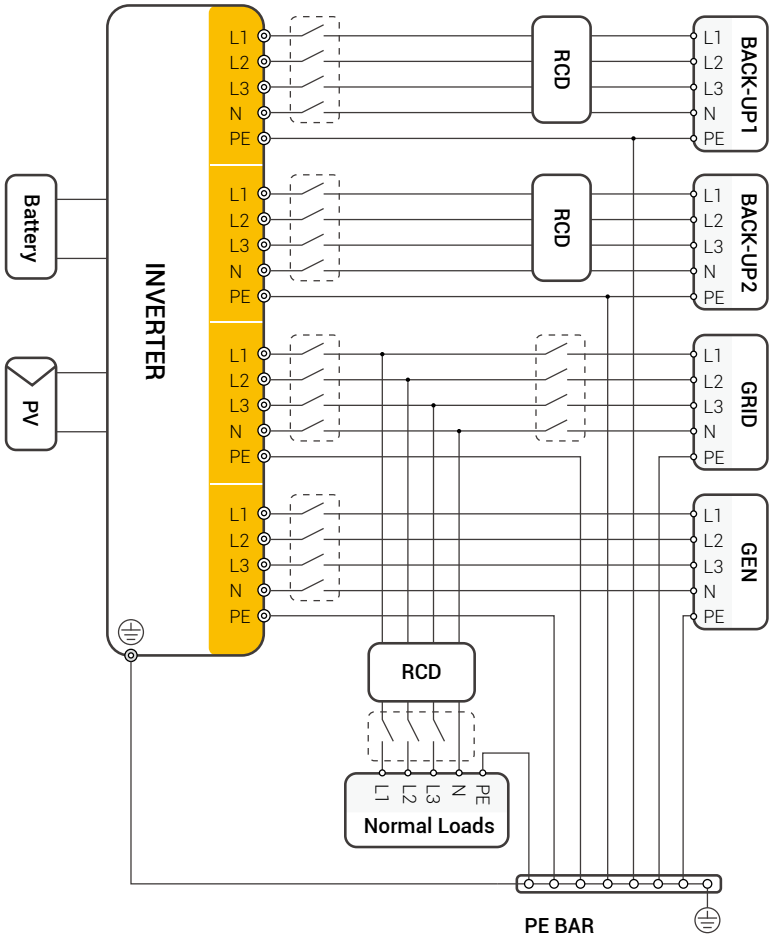

The grounding screw hole of inverter is at the lower right corner.

I-Version applies to wiring rules that require that the N (neutral) wire of other power sources must not be isolated or switched (applicable to Australian and New Zealand wiring rules AS/NZS\_3000:2012).

Figure 2-3 I-Version system diagram

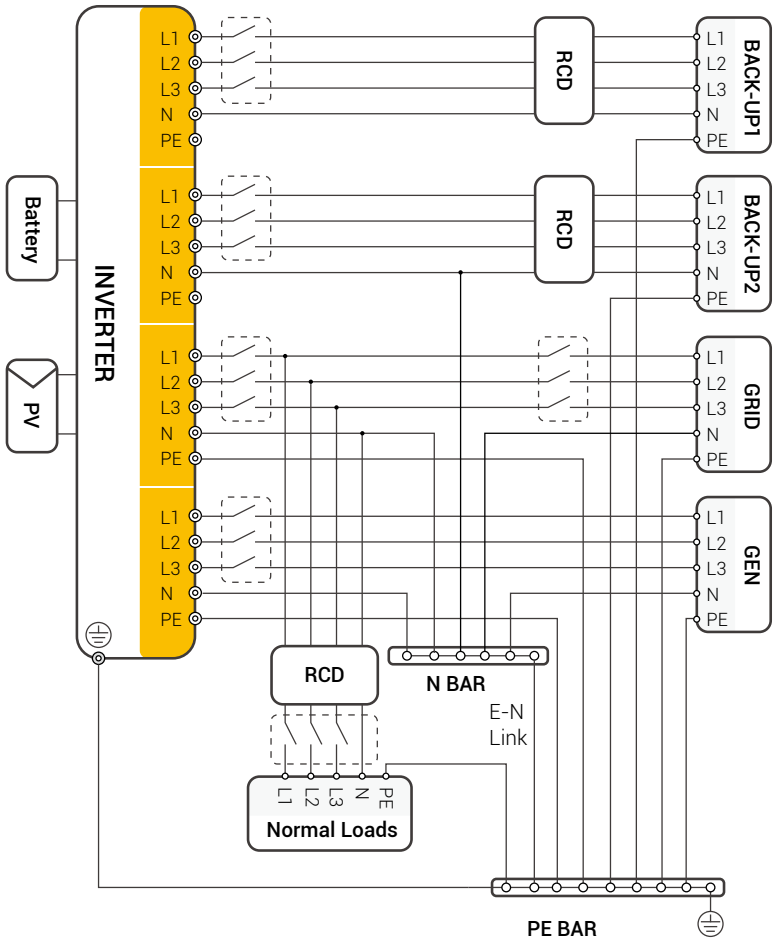

The grounding screw hole of inverter is at the lower right corner.





- Please control the household load and make sure it is within the "EPS output rating" in EPS mode, otherwise the inverter will shut down and issue an "overload fault" warning.
- Please check with the main grid operator for any special grid connection regulations.
- The wiring diagram is for reference only and the complete electrical connection should comply with the local regulations.
- Do not misconnect the phase sequence. Otherwise, the inverter will not operate properly.

## 2.3 Work Modes

The inverter offers multiple working modes according to different requirements.

### Work mode: self-use

I. When PV, Grid, Battery is available:

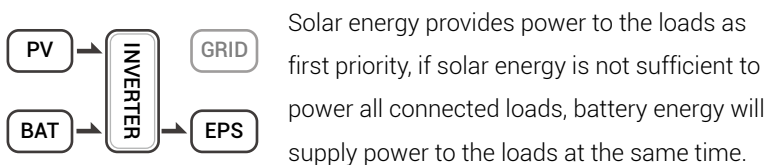
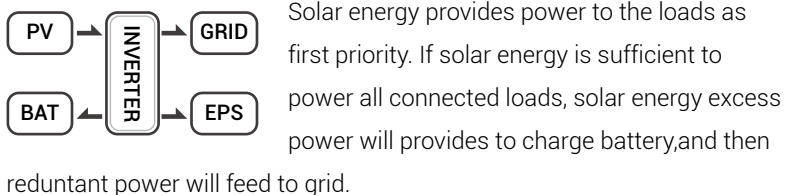

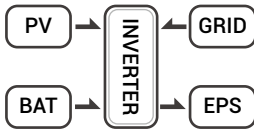

Solar energy provides power to the loads as first priority, if solar energy and battery are not sufficient to power all connected loads, utility energy (Main Grid) will supply power to the loads with solar energy at the same time.

II. When PV, Grid is available(without battery):

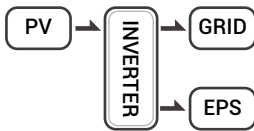

Solar energy provides power to the loads as first priority.if solar energy is Inverter sufficient,the excess power will feed to grid.

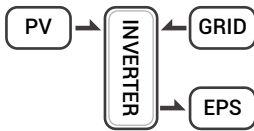

Solar energy provides power to the loads as first priority, if solar energy is not sufficient to power all connected loads, Grid energy will supply power to the loads at the same time.

III. When PV, Battery is available (Grid is disconnected):

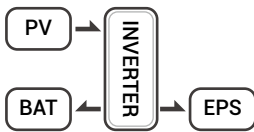

Solar energy provides power to the loads as first priority .if solar energy is sufficient to power all connected loads, solar energy will provides to charge battery.

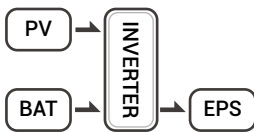

Solar energy provides power to the loads as first priority.if solar energy is not sufficient to power all connected loads, battery energy and solar energy will supply power to the loads at the same time.

## Work mode: peak shift

I. When PV, Grid, Battery is available:

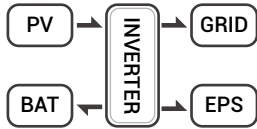

On charge time, solar energy will charge battery as first priority. The excess energy will supply power to the loads. If solar energy is sufficient to supply loads and charge battery, and if there's still some extra energy, then the excess power will feed the power to grid.

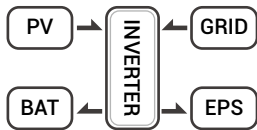

On charge time, solar energy will charge battery as first priority, then the excess solar energy will supply power to loads. If solar energy is not sufficient to charge battery and supply loads, grid will supply all the connected loads with solar energy together.

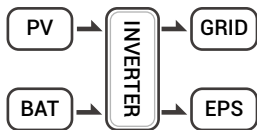

On discharge time, solar energy provides power to the loads as first priority. If solar energy is sufficient to supply loads, and if there's still some extra energy from solar energy, then the excess power and battery will deliver the power to the grid at the same time.

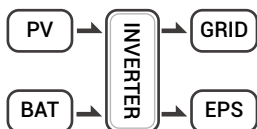

In the period of no charge or discharge, the solar power supply loads at first priority, excess energy to the grid.

II. When Grid, Battery is available (PV is disconnected):

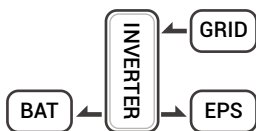

On charge time, grid will charge battery and supply power to the connected loads at the same time.

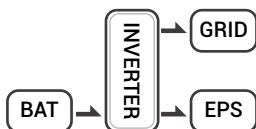

On discharge time, if load power is less than battery power, battery will supply power to loads as first priority. The excess power will be fed to grid.

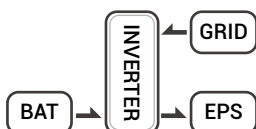

On discharge time, if load power is more than battery power, battery and grid will supply power to the loads at the same time.

### Work mode: BAT priority

I. When PV, Grid, Battery is available:

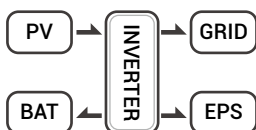

Solar energy will charge battery as first priority, if solar energy is excess.

the excess power will supply load. If there's still some extra energy, then the excess power will

feed the power to grid.

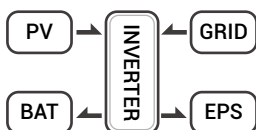

Solar energy will charge battery as first priority, if solar energy is excess the excess power will supply load. If solar energy is not sufficient to charge battery and supply loads, grid will supply

power to loads.

II. When Grid, Battery is available (PV is disconnected):

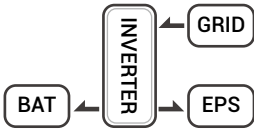

Grid will supply power to load and charge battery at the same time.



If the anti-reverse function is set to be allowable, the system will not feed power to grid in self-use, peak shift, battery priority modes.

## 2.4 Dimensions

Figure 2-4 Dimensions

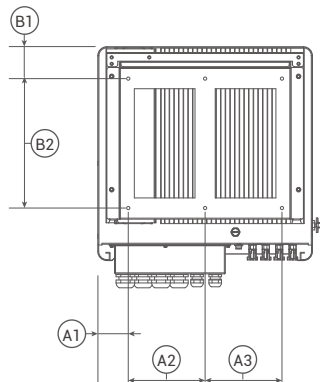
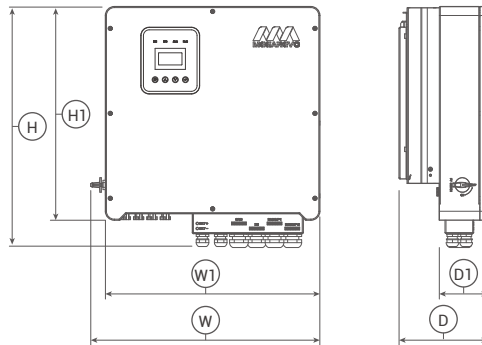

**R6KH3, R8KH3, R10KH3, R12KH3, R15KH3**

W	H	D	W1	H1	D1	Mounting hole dia.
566	596	200	530	528	120	
A1	A2	A3	B1	B2		
75	190	190	79	320		

*Unit, mm*

## 2.5 Terminals

Figure 2-5 Terminals

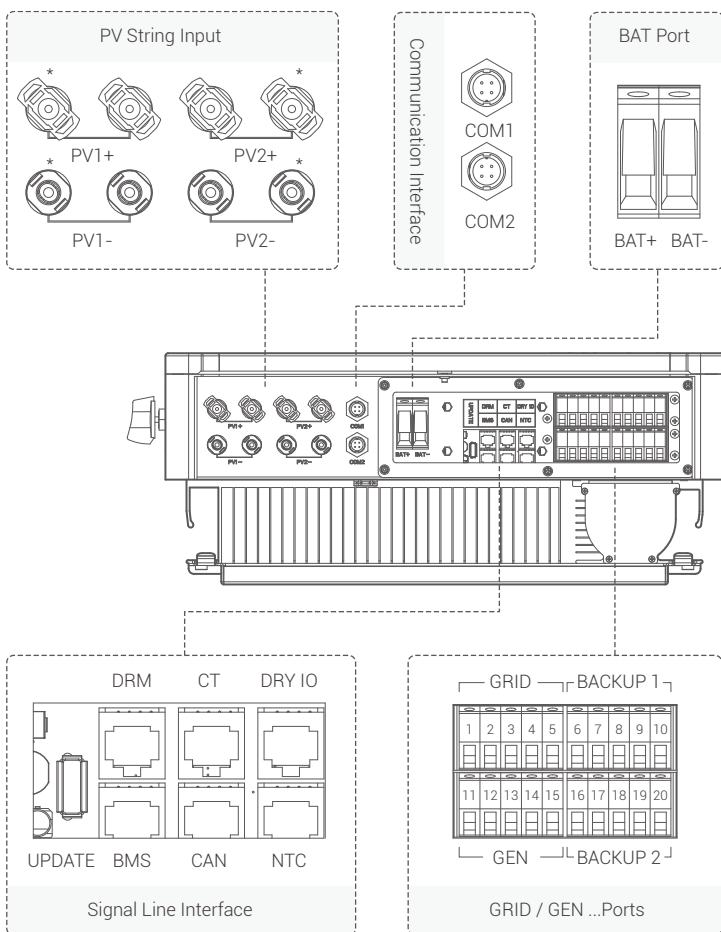

Table 2-1 Terminals

PV1+	PV string 1 positive input
PV1-	PV string 1 negative input
PV2+	PV string 2 positive input
PV2-	PV string 2 negative input
COM1	GPRS port(optional)
COM2	WIFI port (optional)
BAT+	Battery positive input
BAT-	Battery negative input
UPDATE	Port for upgrading software
DRM	Function temporarily retained
CT	Connect to CT (current transformer)
DRY IO	Dry contact
BMS	BMS communication with battery
CAN	CAN communication
NTC	NTC detection

*\*: Only R15KH3 will use these plugs, which are reserved for other models.*

#### GRID (Diesel generator function is unreleased currently)

1	Grid line A phase
2	Grid line B phase
3	Grid line C phase
4	Grid line null line
5	Grid line ground electrode
<b>GEN</b>	
6	A phase
7	B phase
8	C phase
9	Null line
10	Ground electrode

---

**Backup 1**

11	Backup1 line A phase
12	Backup1 line B phase
13	Backup1 line C phase
14	Backup1 line null line
15	Backup1 line ground electrode

**Backup 2**

16	Backup2 line A phase
17	Backup2 line B phase
18	Backup2 line C phase
19	Backup2 line null line
20	Backup2 line ground electrode

---

## 2.6 Parameters

Table 2-2 Parameters

### PV input

Model	R6KH3	R8KH3	R10KH3	R12KH3	R15KH3
Max. power of PV array	9kW	12kW	15kW	18kW	22.5kW
Max. input voltage	1000 V				
MPPT voltage range	180 V~850 V				
Min. input voltage/start voltage	125 V/235 V				
No. of independent MPPT trackers per MPPT input	2				2
No. of independent MPPT strings per MPPT Input	1/1				2/2
Max. input current per MPPT tracker	13A/13A				20A/20A
Max. short-circuit current per MPPT tracker	16A/16A				30A/30A



## Battery

Model	R6KH3	R8KH3	R10KH3	R12KH3	R15KH3
Battery type	Lithium and Lead Acid Battery				
Battery voltage range	125V ~ 600 V				
Max. charging current / Max. discharging current	50 A / 50A				
Rated. charging current / Rated. discharging current	40A/40A				

## AC output

Model	R6KH3	R8KH3	R10KH3	R12KH3	R15KH3
Nominal AC voltage	3W+N+PE, 220 / 380 V; 230 / 400 V; 240 / 415 V				
AC voltage range	360V~440V				
Rated AC grid frequency	50 Hz / 60 Hz				
AC grid frequency range	50±5Hz / 60±5Hz				
Rated active power	6 kW	8 kW	10 kW	12 kW	15 kW
Rated apparent power	6kVA	8kVA	10kVA	12kVA	15kVA
Max. apparent power	6.6kVA	8.8kVA	11kVA	13.2kVA	16.5kVA
Rated grid output current (@400V)	8.7A	11.5A	14.4A	17.3A	21.7 A
Max. grid output current	9.5A	12.7A	15.9A	19.1A	23.8A
Harmonics THDI (@ Nominal power)	< 3%				

## AC input

Model	R6KH3	R8KH3	R10KH3	R12KH3	R15KH3
Rated grid voltage	3W+N+PE, 220 / 380 V; 230 / 400 V; 240 / 415 V				
Rated grid frequency	50Hz / 60Hz				
Rated active power	12 kW	16 kW	20 kW	24 kW	30 kW
Max. apparent input power from grid	13.2kVA	17.6kVA	22kVA	26.4kVA	33.3kVA
Rated input current from grid	17.3A	23.1 A	28.9A	34.7A	43.4A
Max. input current from grid	19A	25.5 A	31.9A	38.2 A	47.6A

## Backup output

Model	R6KH3	R8KH3	R10KH3	R12KH3	R15KH3
Nominal output voltage	3W+N+PE, 220 / 380 V; 230 / 400 V; 240 / 415 V				
Rated output frequency	50 Hz / 60 Hz				
Rated active power	6kVA	8kVA	10kVA	12kVA	15kVA
Max. apparent output power	6.6kVA	8.8kVA	11kVA	13.2kVA	16.5kVA
Peak active output power	6.6kVA	8.8kVA	11kVA	13.2kVA	16.5kVA
Rated Current (@400V)	8.7A	11.5 A	14.4A	17.3 A	21.7A
Max. output current	9.5A	12.7A	15.9A	19.1A	23.8A
Max. switch time	≤10ms				
Output THDI (@ Linear load)	<2%				

## Efficiency

Model	R6KH3	R8KH3	R10KH3	R12KH3	R15KH3
MPPT efficiency	≥99.5%				
Max efficiency	97.90%	97.90%	98.20%	98.20%	98.50%
Euro efficiency	97.20%	97.20%	97.50%	97.50%	97.6%
Max. battery to load efficiency	97.50%	97.50%	97.50%	97.60%	97.80%

## Safety protection

Model	R6KH3	R8KH3	R10KH3	R12KH3	R15KH3
DC-side disconnection device				○	
PV string reverse polarity protection				○	
All-pole sensitive residual current monitoring unit				○	
Anti-islanding protection				○	
AC output over current protection				○	
AC output short circuit current protection				○	
AC over voltage protection				○	
Protection class (as per IEC 62109-1)				I	
Over voltage category (as per IEC 62109-1)				AC: III; DC: II	

## General data

Model	R6KH3	R8KH3	R10KH3	R12KH3	R15KH3
Power factor at rated power / adjustable displacement	0.99 / 0.8 leading to 0.8 lagging				
Dimensions (W / H / D)	530 / 560 / 220 mm				
Device weight	30 kg	31 kg	31kg	33 kg	34 kg
Installation	Wall-mounted				
Operating temperature range	-25 °C~+60 °C				
Noise emissions (typical)	< 35 dB(A)				
Standby consumption	< 15 W				
Cooling method	Natural convection				
Ingress protection rating (as per IEC 60529)	IP65				
Climatic category (according to IEC 60721-3-4)	4K4H				
Max. permissible value for relative humidity (non-condensing)	0~95%				
Max. operating altitude	4000m (>2000m power derating)				

## Features

Model	R6KH3	R8KH3	R10KH3	R12KH3	R15KH3
Inverter topology (PV / battery)	Transformer less / Transformer less				
User interface	LED & App				
Communication with BMS	RS485 / CAN				
Communication with meter	RS485				
Communication with portal	WIFI stick				
Integrated power control / Zero export control	○ / ○				

## Standard Compliance

Model	R6KH3	R8KH3	R10KH3	R12KH3	R15KH3
Safety	EN 62109-1, EN 62109-2				
EMC	IEC 61000-6-1/-2/-3/-4, IEC 61000-3-11, IEC61000-3-12				

## 3 Installation

### 3.1 Check for Physical Damage

Make sure that the inverter is intact during shipment. If there is any visible damage, such as cracks, please contact your dealer immediately.

### 3.2 Packing List

Open the package and take out the product, please check the accessories first. The package list is shown below.

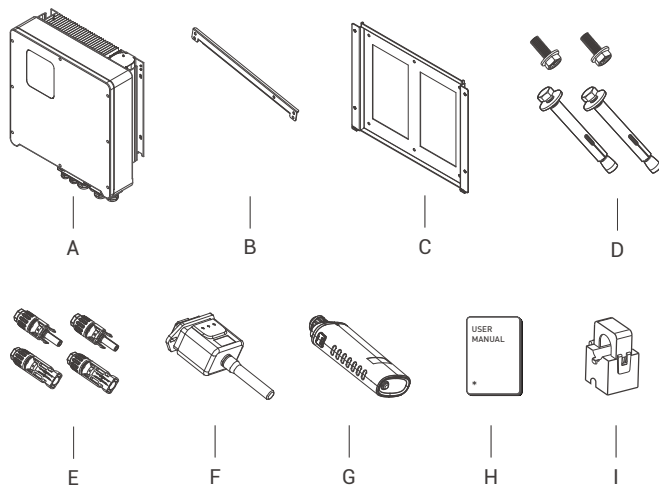

Table 2-3 Parts list

No.	Description	No.	Description
A	Inverter	F	WIFI module (optional)
B	Crossbar	G	GPRS module (optional)
C	Bracket	H	User manual
D	Expansion screws and pan-head screws	I	Current transformer(CT)
E	PV connectors (8K~12K: 2×positive, 2×negative; 15k: 4×positive, 4×negative)		

### 3.3 Mounting

#### 3.3.1 Installation Precaution

REVO Series inverter is designed for outdoor installation (IP 65). Please ensure that the installation location meets the following conditions:

- Not in direct sunlight.
- Not in areas where highly flammable materials are stored.
- Not in potential explosive areas.
- Not in the cool air directly.
- Not near the television antennas or antenna cables.
- Not higher than altitude of about 2000m above sea level.
- Not in environment of precipitation or humidity (>95%).
- Under good ventilation conditions.
- The ambient temperature is between  $-20^{\circ}\text{C}$  and  $+60^{\circ}\text{C}$ .
- The slope of the wall should be within  $\pm 5^{\circ}$ .
- The wall hanging the inverter should meet the following conditions:
  - i. Solid brick/concrete, or a mounting surface of comparable strength;
  - ii. Inverter must be supported or reinforced if the wall's strength isn't enough (such as wooden wall, the wall covered by a thick decorative layer)

Please **AVOIDE** direct sunlight, rain exposure, snow accumulation during installation and operation.



No direct sunlight



No rain exposure



No snow accumulation



### 3.3.2 Space Requirement

Figure 3-1 Space requirement

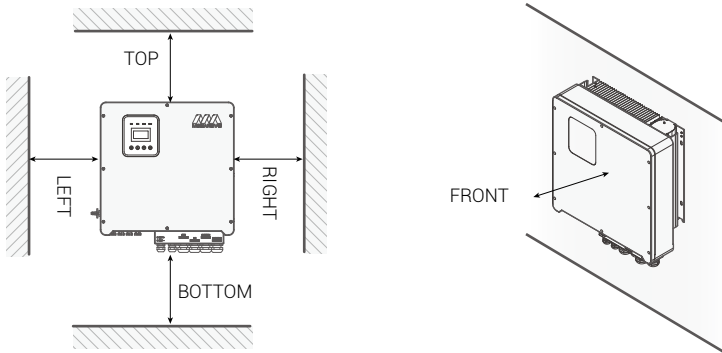

Directions	TOP	BOTTOM	LEFT	RIGHT	FRONT
Min. size (mm)	300	300	300	300	300

### 3.3.3 Installation Procedure

#### Tools:

Terminal blocks, RJ45 crimping pliers, screwdrivers, hand wrenches and drills, etc.

**Step 1:** Mounting the wall bracket on the wall

1. Place the bracket on the wall, mark the location of the four holes and then remove it.
2. Drill holes with an drill, making sure they are deep enough (at least 60 mm) to support the inverter.
3. Install the expansion tubes in the holes, and tighten them. Then install the wall bracket with the expansion screws.

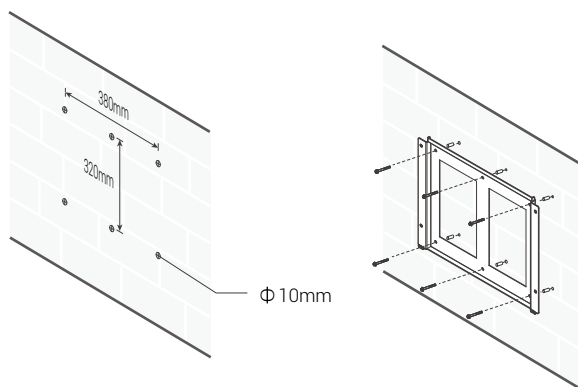
**Step 2:** Use the screws to fix the crossbar as shown in the figure below.



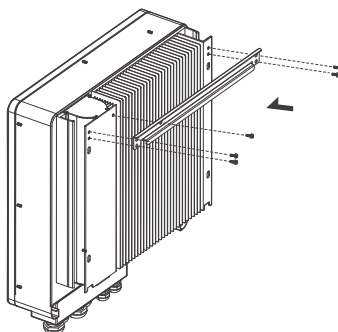

**Step 3:** Place the inverter on the wall-mounted bracket by holding the handle on the side.

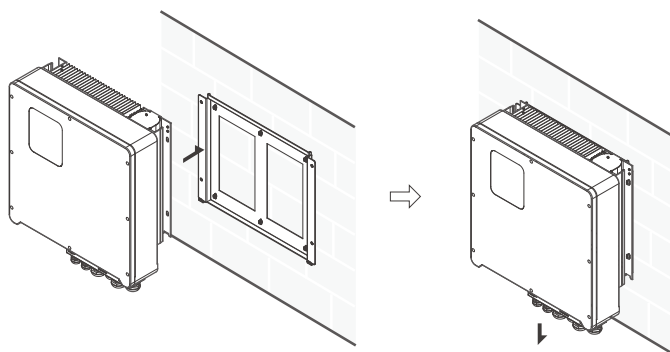

**Step 4:** Tighten the fixing screws on both sides of the inverter.

**Step 5:** If necessary, an anti-theft lock can be installed on the lower left side of the inverter.

## 4 Electrical Connection

### 4.1 PV connection

Revo series Hybrid can be connected in series with 2-strings PV modules for 6KW,8KW,10KW,15KW .

Select PV modules with excellent function and reliable quality. The open-circuit voltage of module arrays connected in series should be less than Max. DC input voltage. Operating voltage should be in accordance with MPPT voltage range.

Table 4-1 Max. DC Voltage Limitation

Model	R6KH3	R8KH3	R10KH3	R12KH3	R15KH3
Max. DC Voltage (V)			1000		
MPPT Voltage Range (V)			180~850		



- PV module voltage is very high, which already achieve dangerous voltage range, please comply with electric safety rules when connecting.
- **DO NOT** ground the PV positive and negative terminals.



- The following requirements of PV modules need to be applied for each input area.
- **DO NOT** ground the PV positive and (or) negative terminals.
- To save cables and reduce DC losses, it is recommended to install inverters near the PV modules.



 The following PV connection mode is **NOT** allowed!

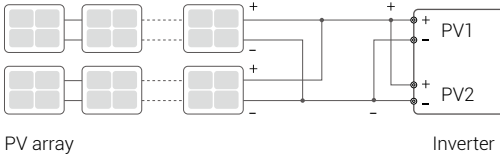

Connection steps:

**Step 1** : Inspect PV modules

1. Measure the module array voltage with a voltmeter.
2. Check the PV+ and PV- from the PV string combiner box correctly.
3. Please make sure the impedance between the positive pole and negative pole of PV to ground should be MΩ level.

**Step 2**: Separate DC Connector

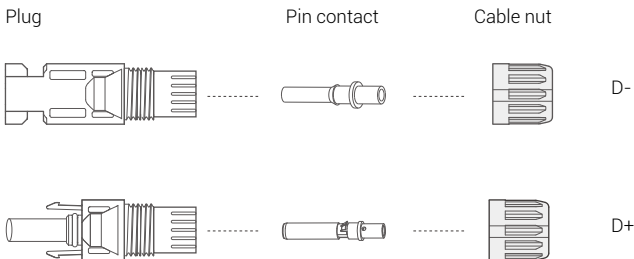

**Step 3** : Wiring

1. Connect the 12 AWG wire to the cold crimp terminal.
2. Remove 10mm of insulation from the end of the wire.
3. Insert the insulator into the pin contact and clamp it with crimping pliers.



**Step 4 :** Insert the pin contact through the nut and into the male or female plug, when a "click" is felt or heard, the pin contact assembly is properly seated. Then tighten the nut.

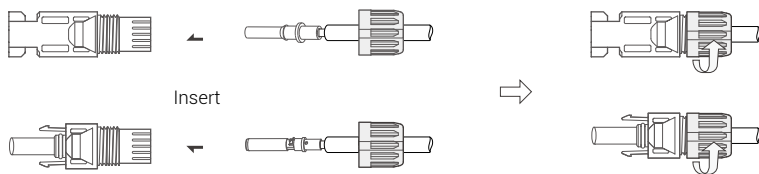

**Step5 :** Plug the PV connector into the corresponding interface on the inverter.

## 4.2 Grid connection

The Revo series inverters are designed for three-phase grids. The voltage is 380/400/415V and the frequency is 50/60Hz. Other technical requirements should be in accordance with the requirements of the local public grid.

Table 4-2 Recommended cables and micro-breakers

Model	R6KH3	R8KH3	R10KH3	R12KH3	R15KH3
Cable (mm <sup>2</sup> )	4~6			6~10	
Micro-breaker (A)	20			32	

Micro-breaker should be installed between inverter and grid, and no load

should be connected directly to the inverter.

Connection steps:

**Step 1** : Check the grid voltage

1. Check the grid voltage and compare it with the allowed voltage range (Refer to technical data).
2. Disconnect the board from all phases and ensure that it is not reconnected.

**Step 2** : Remove the waterproof lid from the grid port on the inverter.

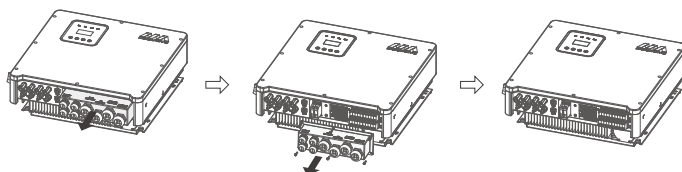

**Step 3** : Make the AC wires.

1. Select the appropriate wire (Cable size: refer to Table 4-2).
2. It is recommended to keep about 60mm length of cable for crimping.
3. Remove 10mm of insulation from the end of wire.
4. Thread the end of the wire into the tubular terminal and use crimping pliers to crimp it tightly.
5. Disassemble the waterproof connector and waterproof cover and thread the cable through the waterproof connector.

**Step 4** : Insert the terminals into each of the three phase grid ports (loosen or tighten the crimp terminal screws with a one-way screwdriver).

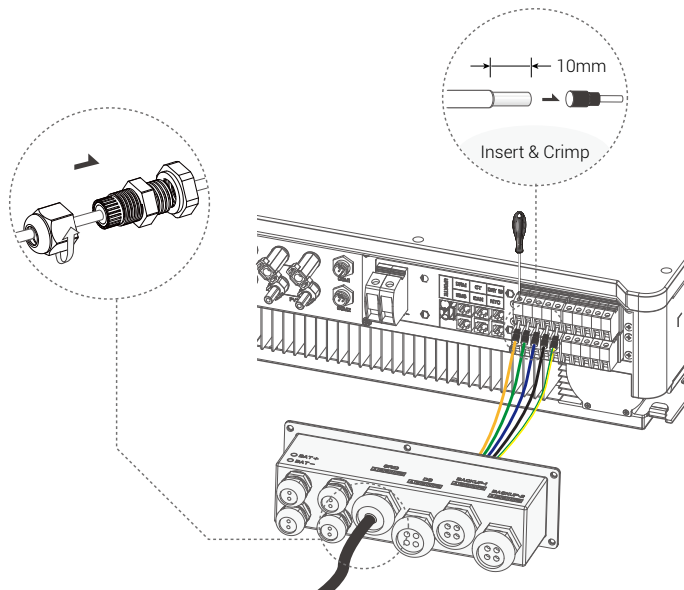

### 4.3 EPS Connection (apply to I Version and E Version only)

The REVO series hybrid inverters have both off-grid and on-grid functions. The inverters output power through the AC port when the grid is on and through the EPS port when the grid is off.

#### I Version & E Version

REVO series inverter provides two versions for customer to choose based on the local rules.

Version I applies to wiring rules that require EPS load-side ground to be isolated from grid-side ground (applies to wiring rules in Australia and New Zealand AS/NZS\_3000:2012)

Version E applies to wiring rules that require the load-side ground of the EPS to be un-isolated from the grid-side ground (applicable in most countries).

## **Auto & Manual**

For the "E version" inverters, the EPS function can be triggered automatically or manually, depending on the user's preference.

For the "I version" inverter, the EPS function can only be triggered automatically.

If the user wants to use this function manually, an external switch needs to be installed. Please refer to the specific wiring diagram below.

For solutions, please contact our sales.

### **E Version Auto**

Transfer switch required.

### **I Version Auto**

No transfer switch required.

Figure 4-1 E-Version system diagram

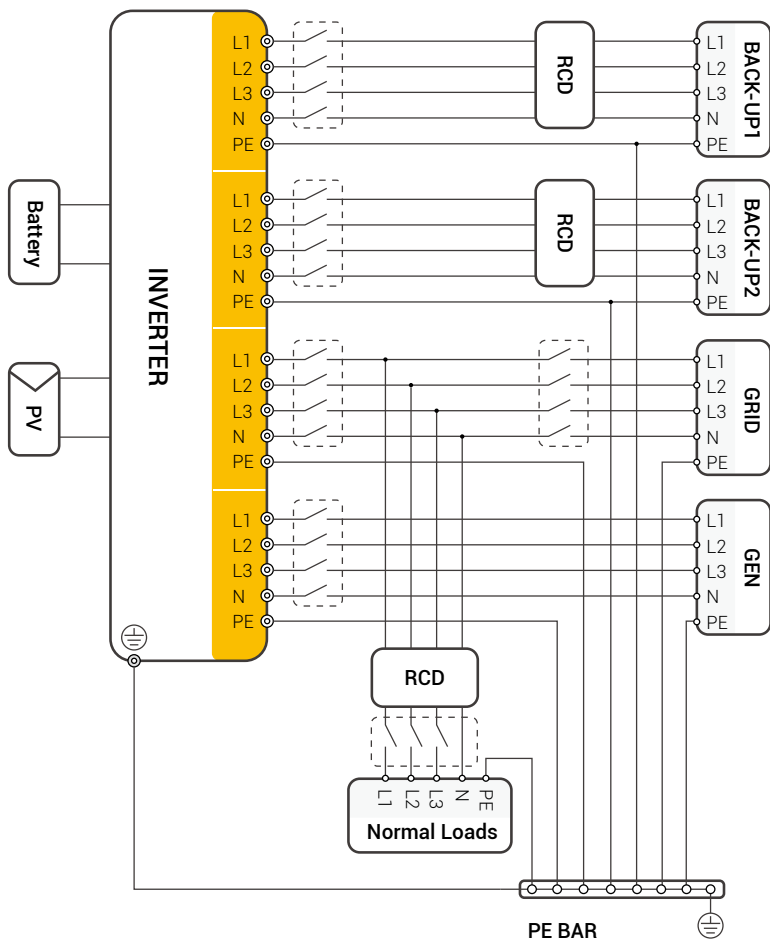

The grounding screw hole of inverter is at the lower right corner.



Figure 4-2 I-Version system diagram

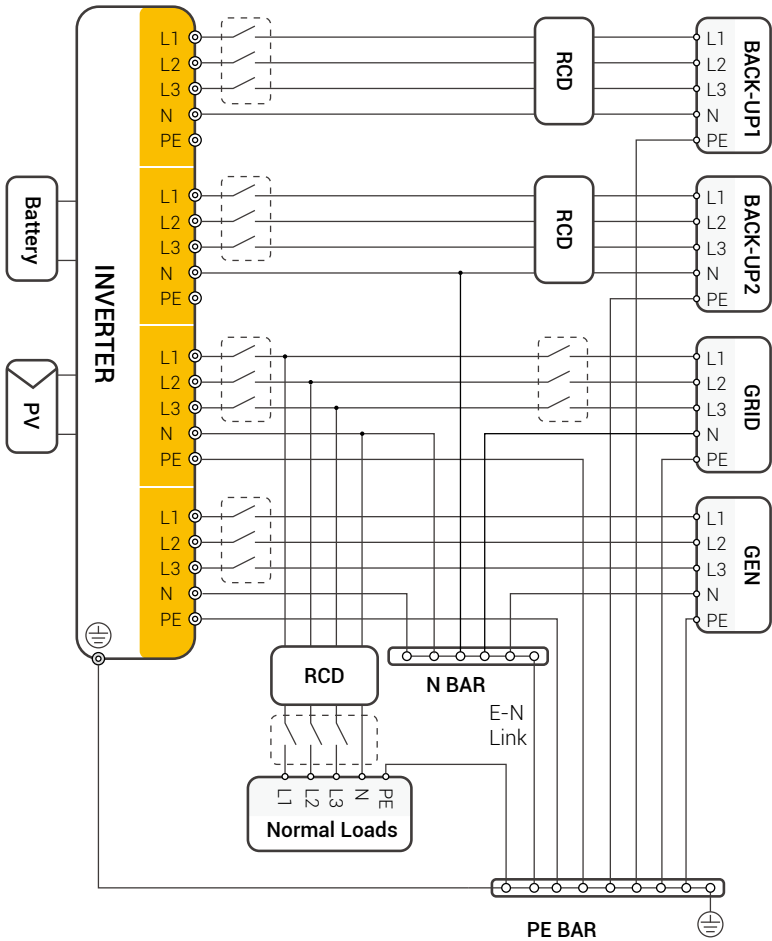

The grounding screw hole of inverter is at the lower right corner.

If you have a request for a compatible contactor, please contact our sales.



If local policies dictate a wiring pattern that is inconsistent with the above operating guidelines, especially for N (neutral) wire, earth and RCD, please contact us before operating! This wiring diagram is for reference only and complete electrical connections should be made in accordance with local regulations.

The REVO series hybrid inverters have grid-on and grid-off functions. When the grid is on, the inverter will output power through the AC port, while when the grid is off, it will output power through the BACKUP ports. BACKUP1 for very important load, BACKUP2 for important or normal load. When there is a power outage or no grid,

- If the battery does not report low voltage or under voltage alarm, the inverter will supply power to both BACKUP1 and BACKUP2.
- If the battery has a low voltage or under voltage alarm, the inverter only supplies power to BACKUP1.
- The total output power of the BACK-UP1 and BACK-UP2 must not exceed the rated output power.

Table 4-3 Recommended cables and Micro-breakers

Model	R6KH3	R8KH3	R10KH3	R12KH3	R15KH3
Cable (mm <sup>2</sup> )	4~6			6~10	
Micro-breaker (A)	20		32		

Connection steps:

**Step 1** : Make EPS wires.

1. Select the appropriate wire (Cable size: refer to Table 4-2).
2. It is recommended to keep about 60mm length of cable for crimping.
3. Remove 10mm of insulation from the end of wire.
4. Thread the end of the wire into the tubular terminal and use crimping pliers to crimp it tightly.

- Disassemble the waterproof connector and waterproof cover and thread the cable through the waterproof connector.

**Step 2 :** Insert the terminals into the EPS port of the inverter (loosen or tighten the crimp terminal screws with a one-way screwdriver).

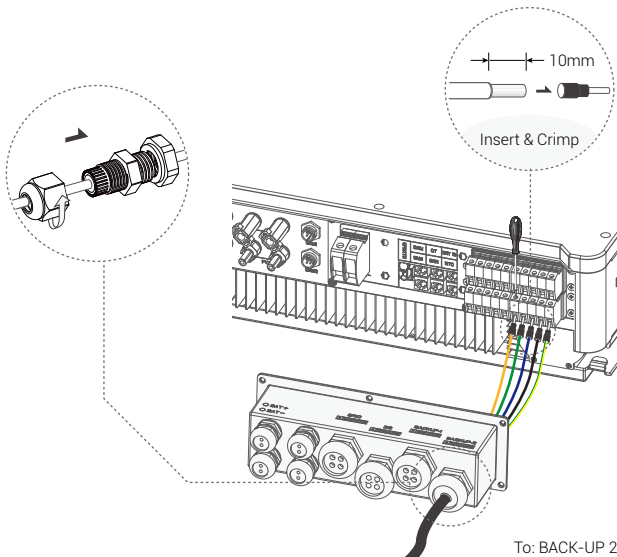
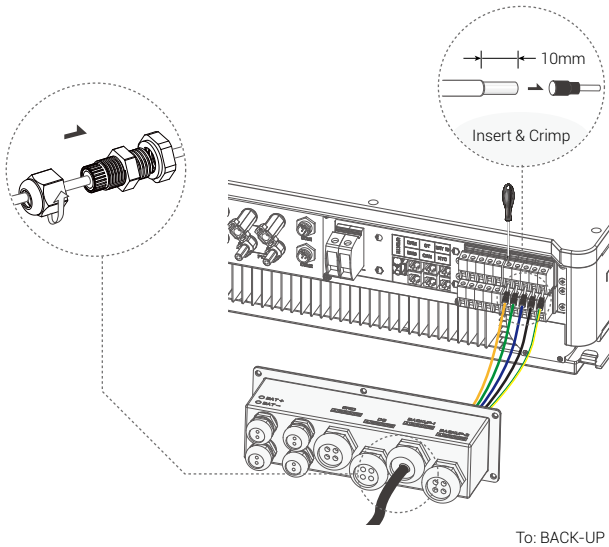

## Requirements for EPS loads







Make sure the rated load power of the EPS is within its rated output range, otherwise the inverter will shut down with an "overload" warning.

When an "overload" occurs, adjust the load power to ensure it is within the EPS output power range before turning on the inverter.



For non-linear loads, make sure that the surge power should be within the output power range of the EPS.

The following table shows some common feasible loads for your reference.

Table 4-4 Common feasible loads for reference

Type	Power		Common equipment	
	Start	Rated		
Resistive load	R1	R1	 Incandescent lamp	 TV
Capacitive load	R2	R1.5	 Fluorescent lamp	
Inductive load	R3~5	R2	 Fan	 Fridge

For example:

Equipment	Power	
	Start	Rated
 Incandescent lamp : <b>100W</b>	100VA (W)	100VA (W)
 Fluorescent lamp: <b>40W</b>	80VA (W)	60VA (W)
 Fridge: <b>150W</b>	450~750VA (W)	300VA (W)

## 4.4 Battery Connection

The charge/discharge system of Revo series hybrid inverters is designed for high voltage lithium batteries.

Before selecting a battery, please note that the battery communication should be compatible with the Revo series hybrid inverter.

### Battery breaker

Before connecting to the battery, install a non-polarized DC circuit breaker to ensure that the inverter can be safely disconnected during maintenance.

Table 4-5 Recommended non-polar DC breaker-breaker

Model	R6KH3	R8KH3	R10KH3	R12KH3	R15KH3
Voltage	Nominal voltage of DC breaker should be larger than maximum voltage of battery				
Current (A)	60				

## Battery connection diagram

Figure 4-3 Battery connection

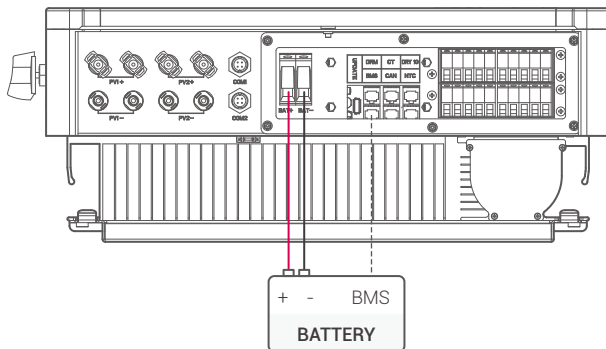

### BMS PIN Definition

The communication interface between the inverter and the battery is RJ45, and its protocol is RS485 or CAN.

Figure 4-4 BMS PIN definition

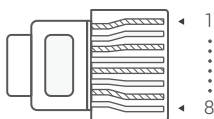

PIN	1	2	3	4	5	6	7	8
RS485	x	x	x	x	x	GND	BMS_485A	BMS_485B
CAN	x	x	x	BMS_CANH	BMS_CANL	x	x	x

When using RS485 protocol, please note that PIN2 must be disconnected.



---

The battery communication can only work when the battery BMS is compatible with the inverter.

---

Battery connection steps:

**Step 1:** Select the 10mm<sup>2</sup> wire and remove 15mm of insulation from the end of wire.

**Step 2:** Thread the end of the wire into the tubular terminal and use crimping pliers to crimp it tightly.

**Step 3:** Disassemble the waterproof connector and pass the cable through the waterproof connector.

**Step 4:** Insert the terminals into battery ports on the inverter.

**Step 5:** Assemble waterproof connectors and waterproof cover.

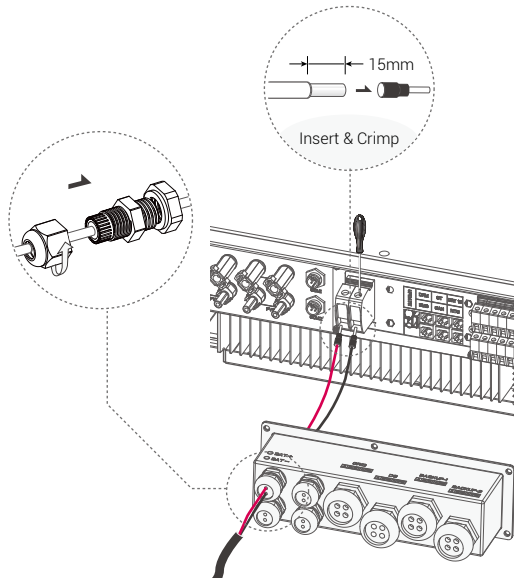

## 4.5 CT Connection and Phase instruction

CT is used for monitoring the power usage for entire house, at the meantime, inverter will also need the data from Meter to achieve the Export Control Function.

Figure 4-5 CT connection and phase wiring diagram

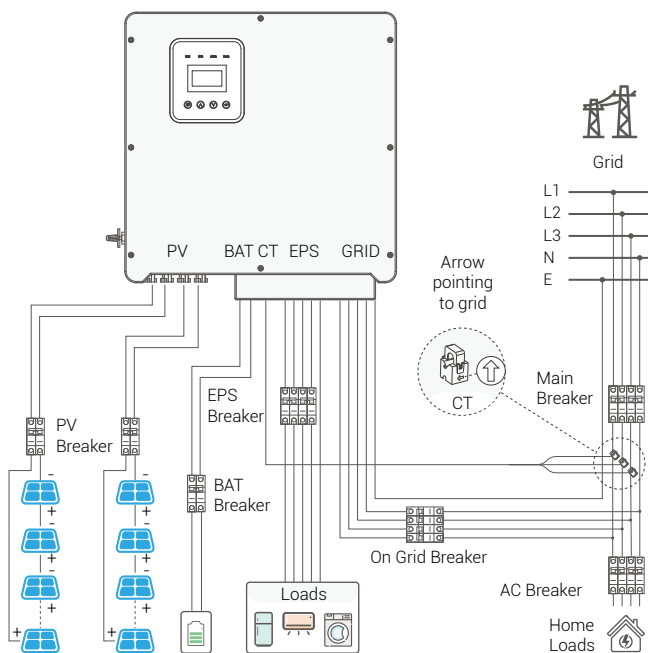

The CT arrow points to the grid, otherwise the inverter will display wrong data or the machine will not work properly.

Pay attention to phase sequence when wiring. With incorrect phase sequence, the inverter will not operate properly.



CT connection steps:

**Step 1:** Disassembly of waterproof connector and waterproof cover.

**Step 2:** Prepare a communication cable (without sheath) and pass the cable through the waterproof connector.

**Step 3:** Insert RJ45 end of the CT cable into the CT port of the inverter.

**Step 4:** Assemble waterproof connectors and waterproof cover.

DRM	CT	Dry Contact
BMS-485	Parallel	NTC
BMS-CAN		

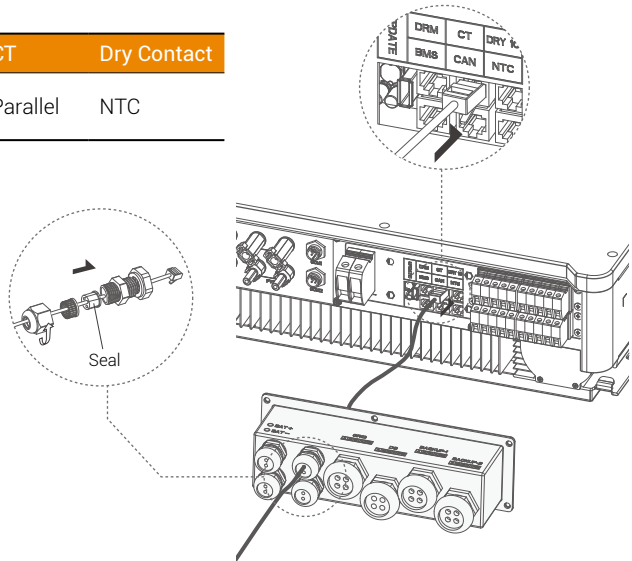

The seal is for waterproofing. Please make sure it is put back in.

## 4.6 DRM Connection (Function temporarily retained)

The DRM supports several demand response modes by transmitting control signals as shown below.

**NOTE:** Only PIN6 (DRM0) is available now, other PIN functions are under development.

Figure 4-6 DRM PIN definition

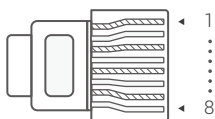

PIN	1	2	3	4	5	6	7	8
Definition	DRM1/5	DRM2/6	DRM3/7	DRM4/8	+5V	DRM0	GND	GND

DRM connection steps:

Please refer to CT steps for DRM connection. Please kindly note that the definition of PIN and the location of the port will be slightly different.

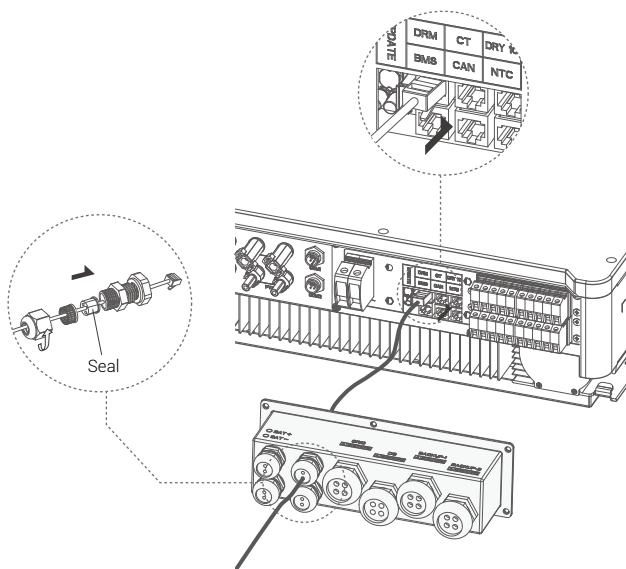

The seal is for waterproofing. Please make sure it is put back in.

## 4.7 WiFi Connection (optional)

The inverter provides a WIFI port that allows data to be collected from the inverter and transmitted to a monitoring website via WIFI.

Purchase this WIFI adaptor from the supplier if needed.

Figure 4-7 WiFi connection diagram

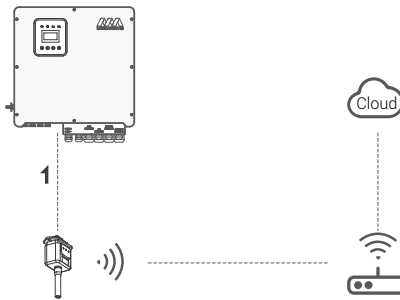

WiFi connection steps:

**Step 1:** Assemble WiFi adaptor to COM2(WIFI) port at the bottom of the inverter.

**Step 2:** Establish the connection between the inverter and the router.

**Step 3:** Create a user account online. (Please check the " WiFi adaptor user manual" for more details).

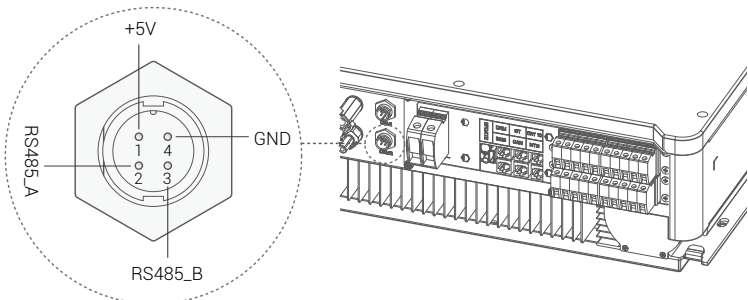

## 4.8 GPRS Connection (optional)

Revo hybrid inverters offer a GPRS (radio frequency) interface to control the switching time of a given load via a smart plug (which can be purchased from the supplier if required), thus allowing the load to consume mainly PV energy during operation and minimizing energy costs.

Figure 4-8 GPRS connection diagram

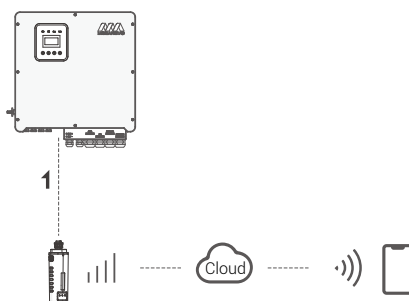

GPRS connection steps:

Please refer to the "Smart Plug user manual" for detailed connection steps. Com1 is the GPRS port.

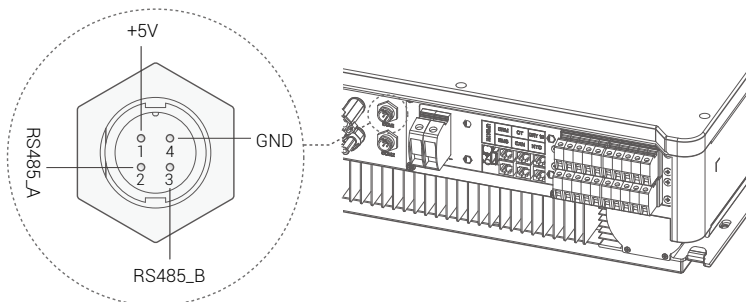

## 4.9 Inverter Manipulation

Start inverter after checking all the following steps:

- ✓ Make sure the inverter is fixed well on the wall.
- ✓ Make sure all DC wiring and AC wiring is complete.
- ✓ Make sure the meter/CT is well connected.
- ✓ Make sure the battery is well connected.
- ✓ Make sure the external load contactor is well connected.
- ✓ (If needed) Turn on the AC switch and EPS switch.
- ✓ Turn on the PV/DC switch and the battery switch.

Check the inverter:

**Step 1:** Check the status of the indicators and the LCD screen. The screen should display the main interface.



---

If the light on the left is not green, please check the following three items:

- All the connections are correct.
  - All the external breakers are switched on.
  - The DC switch on the inverter is in the "ON" position.
- 

**Step 2:** If it is the first time to start, please follow this procedure. For specific settings, please refer to Section 5 (Setting).

**Step 3:** Set up the wifi according to the wifi user manual.

**Step 4:** Perform "self-test". (for Italy only). Self-test according to CEI 0-21 (only for Italy).

The self-test is only used for inverters that are operated and commissioned in Italy.

According to the Italian standard requirements, all inverters entering the utility grid are equipped with a self-test in accordance with CEI 0-21.

During the self-test, the inverters are continuously checked for protection

response times and values for overvoltage, undervoltage, overfrequency and underfrequency.

## 5 Setting

### 5.1 Control Panel

Figure 5-1 Control panel

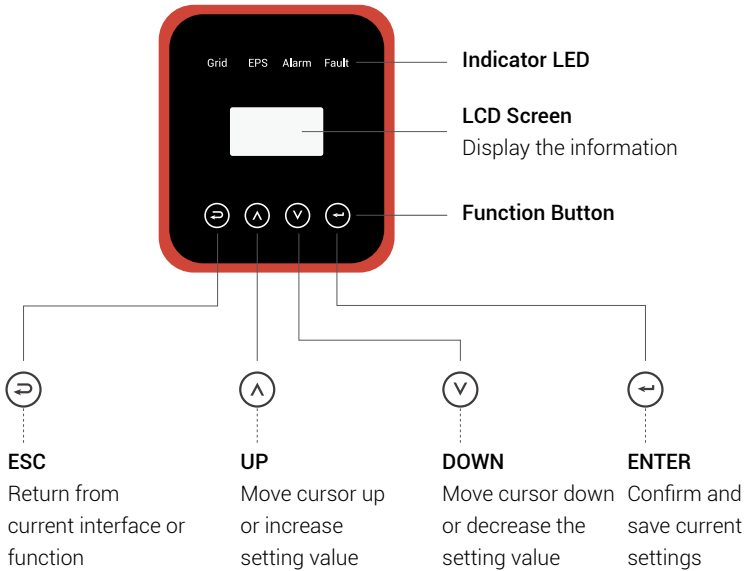

### 5.2 Instructions for LED Indicator

	Grid (Green)	EPS (Green)	Alarm (Yellow)	Fault (RED)
Initialization	OFF	OFF	OFF	OFF
Stand-by	OFF	OFF	OFF	OFF
On-Grid	ON	-	-	-
Off-Grid	OFF	ON	OFF	OFF
Bypass	ON	OFF	OFF	OFF
Fault	OFF	OFF	OFF	ON

### 5.3 Instructions for the use of three modes

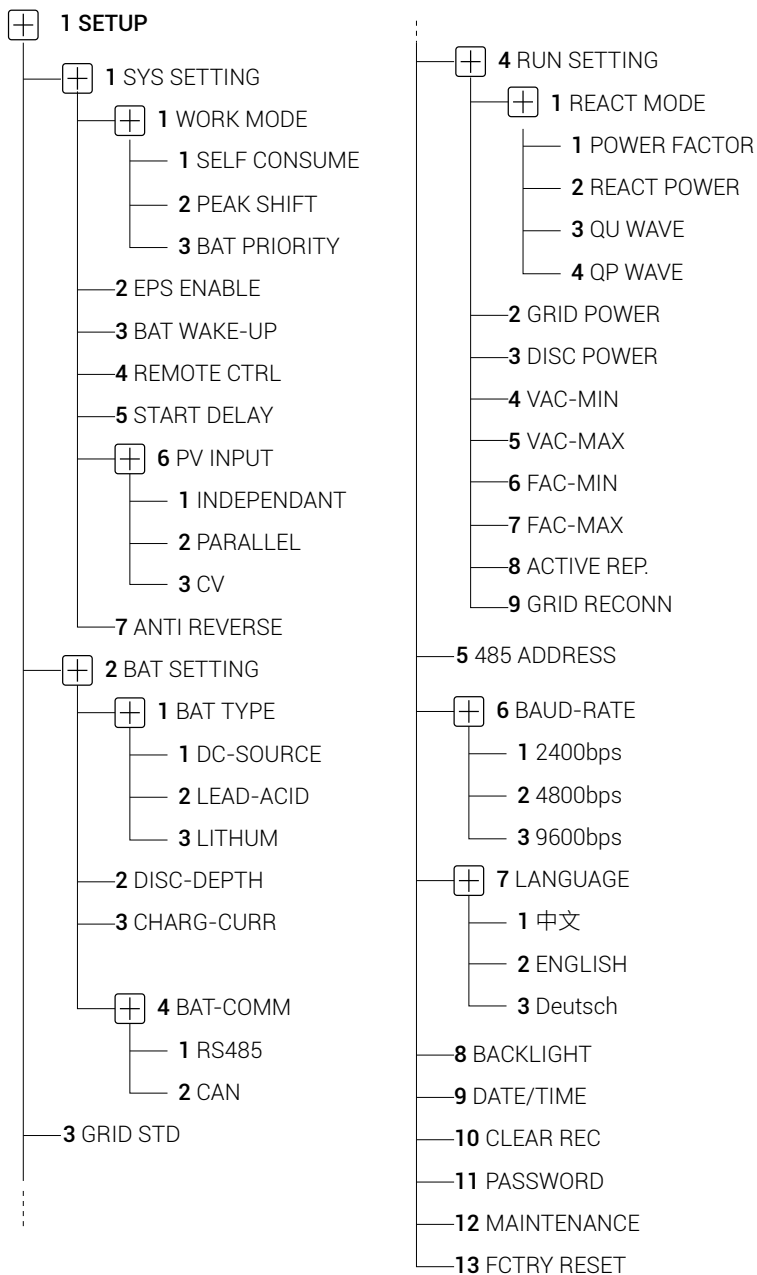



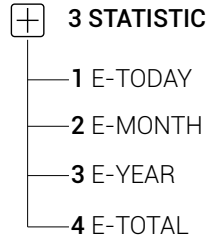
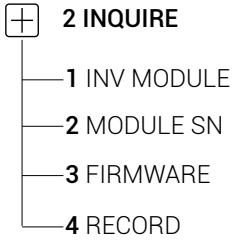

For example: Before selecting the mode, you can set it up according to the local power grid, PV input mode and battery type.

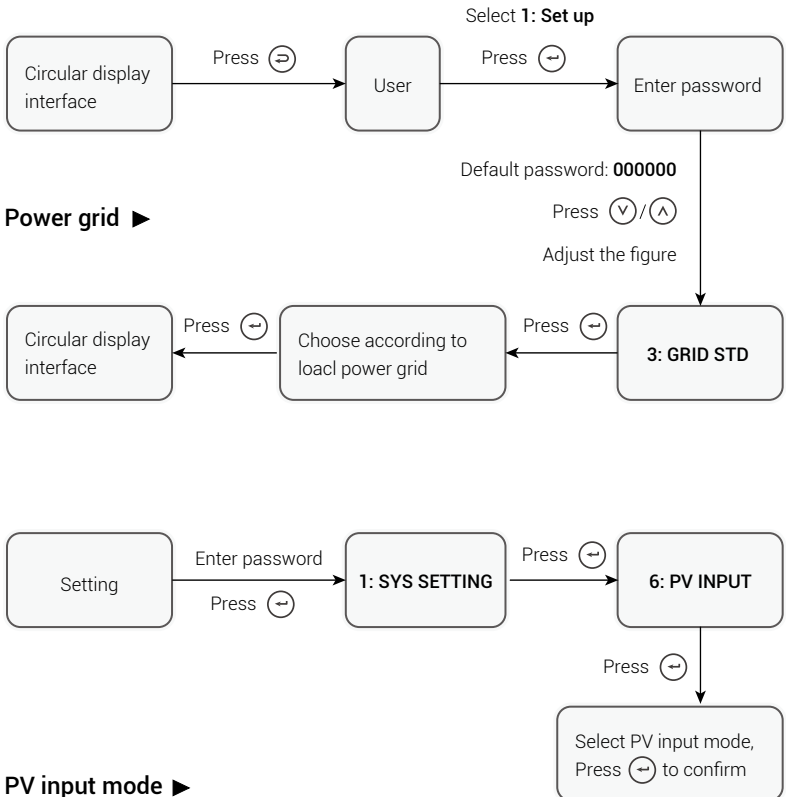

## Battery parameters ►

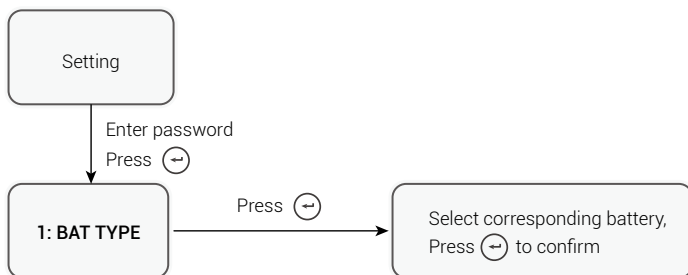



## 6 LCD Operation

### 6.1 LCD Interface

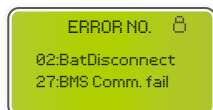
#### 6.1.1 Error information



- Numbers represent error codes and text is error message.
- Refer to Chapter 7 for contents.

**NOTE:** When  appears in the upper right corner of the screen, you cannot turn the page, you need to press  to unlock it first.

#### 6.1.2 System setting 1

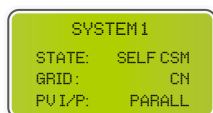

- State: Set the working mode of the whole inverter. Including: SELF CONSUME, PEAK SHIFT and BAT PRIORITY.
- Refer to Chapter 2.3 for specific contents.
- Grid standard: Displays the actual set grid standard.
- PV input mode: The displayed value is the set value for the PV input type, including INDEPENDANT, PARALLEL, CV. See section 4.2 for settings and explanations.

#### 6.1.3 System setting 2

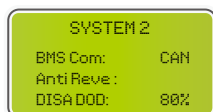

- BMS Com: Battery Management System communication mode, Including CAN or RS485.
- Anti-Reverse :Indicates whether the inverter is not allowed to generate power to the grid, including DISABLE, ENABLE. See section 4.2 for settings and explanations.
- DOD: The depth of discharge of the battery. When the battery is discharged beyond this setting, the inverter will report a low or undervoltage alarm and the battery stops discharging.

### 6.1.4 System setting 3

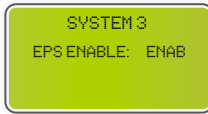

- EPS ENABLE: Enables the battery to supply power to the load when the grid and PV are off, which is enabled by default.

### 6.1.5 PV1 Input display interface

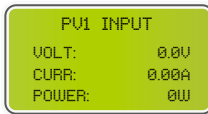

- PV1 input real-time voltage
- PV1 input real-time current
- PV1 input real-time power

### 6.1.6 PV2 Input display interface

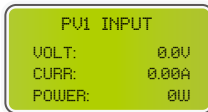

- PV2 input real-time voltage
- PV2 input real-time current
- PV2 input real-time power

### 6.1.7 DC Voltage interface

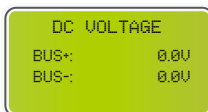

- BUS+: Real-time voltage of bus capacitor of the inverter
- BUS-: Real-time voltage of bus capacitor of the inverter

### 6.1.8 Battery interface

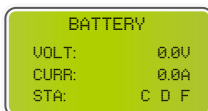

- Battery real-time voltage
- Battery real-time current
- STA: Battery status

C : Indicates that the battery is chargeable (from the BMS).

D : Indicates that the battery can be discharged (from BMS).

F : The battery requires forced charging (from BMS).

### 6.1.9 Battery information interface

BATTERY INFO	
TYPE:	Lithium
TEMP:	26°C
SOC:	30%

- TYPE: Battery type:(lead-acid, lithium battery)
- TEMP: Battery temperature
- SOC: Percentage of battery capacity from the

BMS

### 6.1.10 Battery current interface

BMS PRMETER	
CHAR VOL:	0.0V
CHARGE:	0A
DISCHA:	0A

- CHAR VOL: Max. charging voltage requested by the battery BMS
- CHARGE: Max. charging current requested by

the battery BMS

- DISCHA: Max. discharging current requested by the battery BMS

### 6.1.11 Grid-connected

GRID FREQ:	0.00Hz
U:	0.0V 0.0A
V:	0.0V 0.0A
W:	0.0V 0.0A

- GRID FREQ: Grid real-time frequency.
- CT: Current transformer
- U: Grid-phase U real-time voltage | CT real-

time current

- V: Grid-phase V real-time voltage | CT real-time current
- W: Grid-phase W real-time voltage | CT real-time current

### 6.1.12 INV

INV FREQ:	0.00Hz
U:	0.0V 0.0A
V:	0.0V 0.0A
W:	0.0V 0.0A

- INV FREQ: Grid real-time frequency

- U: INV -phase U real-time voltage | INV -phase U real-time current
- V:INV -phase V real-time voltage | INV -phase V real-time current
- W: INV -phase W real-time voltage | INV -phase W real-time current

### 6.1.13 LOAD

LOAD:	
U: 0.0V	0.0A
V: 0.0V	0.0A
W: 0.0V	0.0A

Synonymy: BACK-UP/EPS/LOAD

- U: Load-phase U real-time voltage | Load-phase U real-time current
- V: Load -phase V real-time voltage | Load-phase V real-time current
- W: Load -phase W real-time voltage | Load-phase W real-time current

### 6.1.14 INV POWER

POWER	
INU U:	0.0W
INV V:	0.0W
INV W:	0.0W

- INV U: INV -phase U power.
- INV V: INV -phase V power.
- INV W: INV -phase W power

### 6.1.15 GRID POWER

POWER	
GRID U:	0.0W
GRID V:	0.0W
GRID W:	0.0W

The CT arrow points to the power grid. The discharge from the inverter to the grid is "+", and the opposite is "-".

- GRID: GRID -phase U power
- GRID: GRID -phase V power
- GRID: GRID -phase W power

### 6.1.16 LOAD POWER PER

LOAD POWER PER	
U:	0W 0%
V:	0W 0%
W:	0W 0%

- U : Load-phase U power percentage
- V : Load-phase V power percentage
- W: Load-phase W power percentage

### 6.1.17 POWER

POWER	
PV:	0W
BAT:	0W

- PV : PV power
- BAT: Battery power

### 6.1.18 Temperature

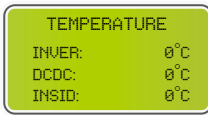

- INVER: DC/AC temperature
- DCDC: DC/DC temperature
- INSIDE: Internal ambient temperature

### 6.1.19 State

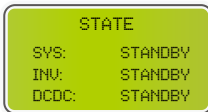

- SYS: Display complete inverter status information, Including: Initialization, Standby, PV connected to grid, Battery connected to

Grid, Hybrid power supply, Fault, Service ,Self -check, Off grid, grid, INV to PFC , Charging enable, Discharge enable, Force charge enable, etc.

- INV: Displays the inverter status information.
- DCDC: Displays charging and discharging status information.

## 6.2 Setting

### 6.2.1 State

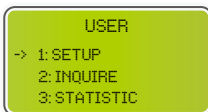

- SETUP: Press to enter user settings interface.
- INQUIRE: Query inverter model, serial number,

software version.

- STATISTIC: View inverter operating statistics.

### 6.2.2 Set password

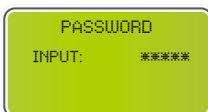

- Enter the password required for setting. The default password is "00000".
- Press or to adjust the number, press

to move the cursor forward, and press move the cursor backward.

### 6.2.3 Setup

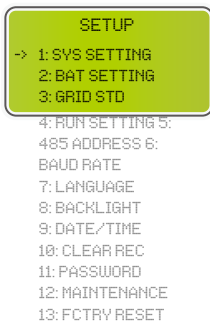

- This interface is used for various information inquiry menus.
- Press  $\uparrow$ / $\downarrow$  to select the corresponding option.
- Press  $\rightarrow$  to enter the selected menu.
- Press  $\leftarrow$  to return to the user interface. (Refer to 6.2.1).
- There are 13 options in total.

### 6.2.4 System setting

#### 6.2.4.1 System setting

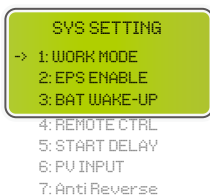

- This interface is used to access system information.
- Press  $\uparrow$ / $\downarrow$  to select corresponding option.
- Press  $\rightarrow$  to enter the selected menu.
- Press  $\leftarrow$  to return to the setting interface.
- There are 7 options in total.

#### 6.2.4.2 Work mode

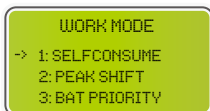

- This interface is used to select the working mode.
- Press  $\leftarrow$  to return to setting interface.



### 6.2.4.3 Peak shift work time

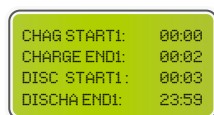
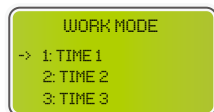
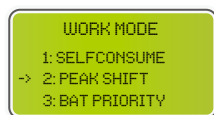

- This interface is used to select the working mode.
- Press  $\odot$  to return to setting interface.
- Select the peak shift mode, you also need to set the charge and discharge time.
- It's allowed to set 3 charging and discharging periods.
- When setting the time, ensure that the time of the inverter is the local time.
- Press  $\ominus$  to enter the next menu.
- This parameter is set to one day. If the specified time conflicts, the first time is executed as the primary time. If the three time ranges do not conflict, the three time ranges are executed sequentially.
- This interface is used to adjust the timing of battery charging and discharging during peak periods.
- Press  $\wedge$ / $\vee$  to select the corresponding option.
- Press  $\ominus$  to enter the selected menu.
- Press  $\odot$  to return to the working mode interface.

### 6.2.4.4 EPS enable

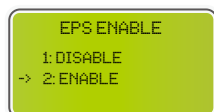

- When the Grid and PV are powered OFF, enable the battery to supply power to the load, default option is enable.

#### 6.2.4.5 Battery wake-up

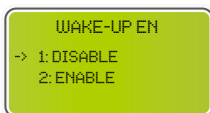

- When the battery is low and the battery relay has been disconnected, the inverter will send a signal through the BMS to the battery force-suck relay and the inverter will charge.
- The default option is disabled. (Supported by partial lithium batteries)
- If you want to use this function, please consult your dealer for supported battery brands. Use only when the battery is too low.

#### 6.2.4.6 Dormancy enable

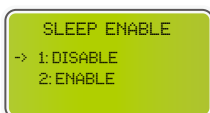

- Reserved

#### 6.2.4.7 PV input mode

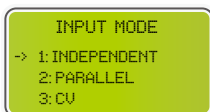

- Setup of PV Input mode.
- End users please select INDEPENDENT mode.
- PARALLEL & CV modes for testing purposes only.

#### 6.2.4.8 Anti Reflux

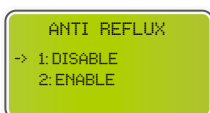

- Anti- Reflux: Whether the inverter is not allowed to supply power to the grid.
- The default option is disable.

#### 6.2.4.9 Home load

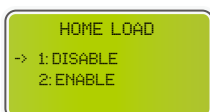

- Press  $\uparrow$ / $\downarrow$  to select the corresponding option.
- Press  $\rightarrow$  to confirm.

## 6.2.5 Bat setting

### 6.2.5.1 Bat setting

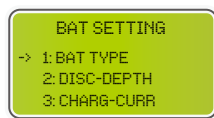

- This interface is the battery parameters menu.
- Press  $\uparrow/\downarrow$  to select corresponding option;
- Press  $\leftarrow$  to enter the selected menu;
- Press  $\rightarrow$  to return to setting interface.

### 6.2.5.2 Bat type

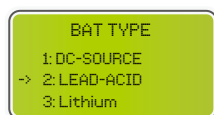

- This interface is used to select battery type.
- Press  $\uparrow/\downarrow$  to select corresponding option;
- Press  $\leftarrow$  to enter the selected menu.
- Select the LEAD-ACID , press  $\leftarrow$  to enter LEAD-ACID interface;
- Option 1 is used for R&D testing and is disabled for customers.

### 6.2.5.3 Lead-acid battery parameter

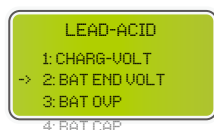

- This interface is LEAD-ACID battery parameters menu.
- Press  $\uparrow/\downarrow$  to select corresponding option;
- Press  $\leftarrow$  to enter the selected menu;

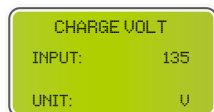

- This interface is used to set the lead acid battery charging voltage. (The input value ranges from 135 to 600)

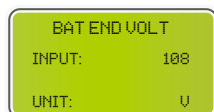

- This interface is used to set the lead-acid battery discharging voltage.(The input value ranges from 108 to 600)
- Cut-off discharge voltage, as recommended by the battery manufacturer.

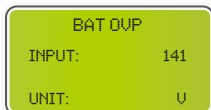

- This interface is used to set the lead acid battery charge protection voltage. (The input value ranges from 141 to 600)
- Charge protection voltage, as recommended by the battery manufacturer.

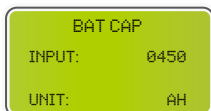

- This interface is used to set the lead acid battery capacity. It is related to the input power. (The input value ranges from 50 to 1000)
- The battery capacity setting will affect the maximum charging current. For example, if it is set to 100Ah, the maximum charging current will be  $100A \times 0.2 = 20A$ .

#### 6.2.5.4 Bat-comm



- This interface is used to select battery communication BMS type.
- Press  $\uparrow$ / $\downarrow$  to select corresponding option;
- Press  $\rightarrow$  to confirm;
- The default option is CAN.

## 6.2.6 Grid standard



GRID STD  
 -> 1: AU  
 2: AU-W  
 3: NZ  
 4: UK  
 5: VDE  
 6: KR  
 7: PHI  
 8: CN  
 9: US-CA  
 10: THAIL  
 11: ZA  
 12: CUSTOM  
 13: POL  
 14: EN50549  
 15: VDE4105  
 16: JPN  
 17: ITA  
 18: SLO  
 19: CZE  
 20: SWE  
 21: HU  
 22: SK

- This interface is used to select Grid standard.
- Press  $\uparrow$ / $\downarrow$  to select the corresponding option.
- Press  $\rightarrow$  to confirm.

1:AU-Australia	240V/415V 50Hz
2:AU-W-Western Australia	240V/415V 50Hz
3:NZ-New Zealand	240V/415V 50Hz
4:UK-United Kingdom	230V 50Hz
5:PK	230V 50Hz
6:KR-Korea	220V/380V 60Hz
7:PHI-Philippines	110V/220V 60Hz
8:CN-China	220V/380V 50Hz
9:US-CA-America	120V/240V208V/240V 60Hz
10:THAIL	220/380V 50Hz
11:ZA	230V 50Hz
12:CUSTOM-User defined	-
13:POL	230V/380V 50Hz
14:EN50549	217V/220V/240V 380V/400V 50HZ/60Hz
15:VDE4105-Germany	230V/380V 50Hz
16:Japan	110V/190V/60Hz
17:Italy	230V/380V/50Hz
18: Slovenia	230V/380V/50Hz
19: Czech Republic	230V/380V/50Hz
20: Sweden	230V/380V/50Hz
21: Hungary	230V/380V/50HZ
22: Slovakia	230V/380V/50Hz

If none of the above options are available, please consult your dealer.

## 6.2.7 Run setting

### 6.2.7.1 Run setting

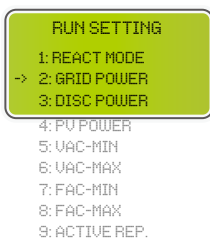

- This interface is run setting menu.
- Press  $\uparrow$ / $\downarrow$  to select the corresponding option.
- Press  $\leftarrow$  to enter the selected menu.
- To modify the factory default settings, please contact your dealer.

### 6.2.7.2 React mode

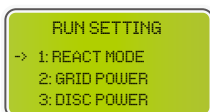

- This interface is used to select react mode.
- Press  $\uparrow$ / $\downarrow$  to select the corresponding option.
- Press  $\leftarrow$  to enter the selected menu.

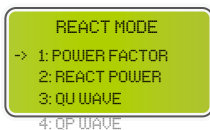

- QU WAVE (Reserved)
- QP WAVE (Reserved)

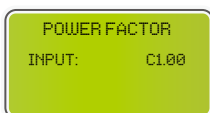

- The input value should range between L0.80 and L0.99 or C0.8 and C1.00.

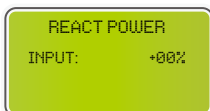

- The input value should range between -60% and +60%, which varies with the standard.

### 6.2.7.3 Grid power

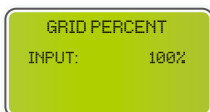

- The input value is the power percent of the grid.

#### 6.2.7.4 Discharge power

DISC PERCENT	
INPUT:	100%

The input value is the power percent of battery discharge.

#### 6.2.7.5 PV power

PV PERCENT	
INPUT:	100%

The input value is the power percent of PV.

#### 6.2.7.6 VAC-Min

GRID VOLT LOW	
INPUT:	176
UNIT:	V

The input value of grid low voltage. (This is valid only if the grid standard is "custom")

#### 6.2.7.7 VAC-Max

GRID VOLT HIGH	
INPUT:	250
UNIT:	V

The input value of grid high voltage. (This is valid only if the grid standard is "custom")

#### 6.2.7.8 FAC-Min

GRID FREQ LOW	
INPUT:	42.0
UNIT:	Hz

The input value of grid low frequency. (This is valid only if the grid standard is "custom")

#### 6.2.7.9 FAC-Max

GRID FREQ HIGH	
INPUT:	60.0
UNIT:	Hz

The input value of grid high frequency.(This is valid only if the grid standard is "custom")

### 6.2.7.10 Active rep.

ACTIVE REP.  
1: PWR-VOLT RES  
-> 2: PWR-FREQ RES  
3: PFC-VOLT RES

4: PFC-FREQ RES  
5: ACTIVE ISLAND  
6: LEAK CURRENT  
7: INSULATION DETE

This interface is used to enable or disable the relevant function for on-grid operation.

- Press  $\uparrow/\downarrow$  to select corresponding option;
- Press  $\rightarrow$  to enter the selected menu;

1: PWR-VOLT RES	Generation voltage response
2: PWR-FREQ RES	Generation frequency response
3: PFC-VOLT RES	Charging voltage response
4: PFC-FREQ RES	Charging frequency response
5: ACTIVE ISLAND	Active island detection
6: LEAK CURRENT	Leakage current detection
7: INSULATION DETE	Insulation Inspection

ACTIVE ISLAND  
1: DISABLE  
-> 2: ENABLE

- Press  $\uparrow/\downarrow$  to select corresponding option;
- Press  $\rightarrow$  to confirm;

### 6.2.7.11 Grid reconnect

GRID RECONN  
INPUT: 90 SEC

This feature is a custom function, the default is allowed and does not need to be set. For adjustment, please consult your dealer.

### 6.2.8 485 address

485 ADDRESS  
INPUT: 1

This interface is used to set 485 address.



### 6.2.9 Baud rate

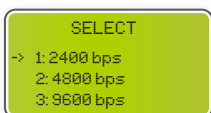

This interface is used to select baud rate.

### 6.2.10 Language



This interface is used to select language.

### 6.2.11 Backlight

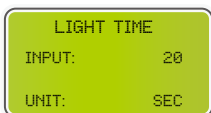

This interface is used to set backlight duration of LCD.

### 6.2.12 Date/time

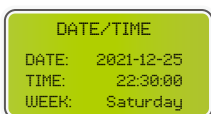

This interface is used to set date and time.

### 6.2.13 Clear REC

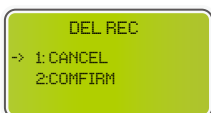

This interface is used to clear operation history.

### 6.2.14 Password

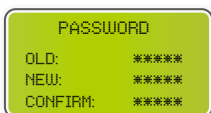

This interface is used to set password.

## 6.2.15 Maintenance

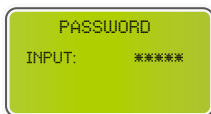

Reserved.

## 6.2.16 Factory reset

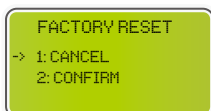

This interface is used to reset the inverter.

## 6.3 Inquire

### 6.3.1 Inquire

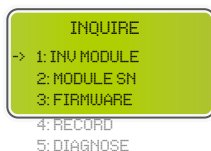

- Press  $\uparrow$ / $\downarrow$  to select corresponding option;
- Press  $\leftarrow$  to enter the selected menu.
- Press  $\rightarrow$  to return to other interface.

### 6.3.2 INV module

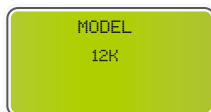

This interface displays inverter model.

### 6.3.3 Module SN

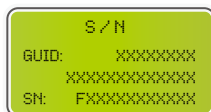

This interface displays module SN.

### 6.2.4 Firmware

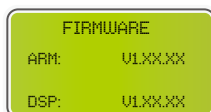

This interface displays software version.

### 6.3.5 Running records



This interface displays running recorders.

### 6.3.6 Diagnose

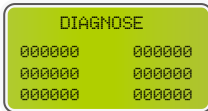

For internal use in the factory.

## 6.4 Statistic

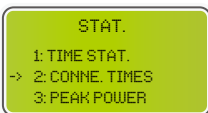

This interface displays inverter operation statistics.

- 1: Displays inverter operation and grid-connection time statistics.
- 2: Displays inverter Grid-connection times.
- 3: Displays power peak in history and for the day.
- 4: Displays the amount of power generated for the day (KWh).
- 5: Displays the amount of power generated for the month (KWh).
- 6: Displays the amount of power generated for the year (KWh).
- 7: Displays the total amount of power generated (KWh).

#### NOTE:

If the inverter is shut down before 24:00 of the day, the statistics of the day will not be stored.

## 7 Fault diagnosis and solutions

The following table lists some basic problems that may occur in practice and the corresponding basic solutions. When you encounter the following problems, please refer to the following solutions.

If the problem is still not solved, please contact your local distributor.

<b>Codes:</b>	00	<b>Solutions:</b>
<b>Content:</b>	DischgOverCur	<ul style="list-style-type: none"> <li>• Nothing need to do, Wait one minute for the inverter to restart.</li> <li>• Check whether the load is in compliance with the specification.</li> <li>• Disconnect all power and shut down all inverters; disconnect the load and restart the inverter with power.</li> </ul>
<b>Explanation:</b>	<p>Battery discharge over current.</p> <p>When the battery is loaded, the load is too large.</p>	
<b>Codes:</b>	01	<b>Solutions:</b>
<b>Content:</b>	Over Load	<ul style="list-style-type: none"> <li>• Check whether the load is in compliance with the maximum power of the inverter.</li> <li>• Disconnect all power and turn off all inverters; disconnect the load, power up and restart the inverter, and if the fault has been cleared, check the load again for a short circuit.</li> <li>• If the error/warning remains, please contact customer service.</li> </ul>
<b>Explanation:</b>	<p>The load power is greater than other power(PV,BAT).</p>	

<b>Codes:</b>	02	<b>Solutions:</b>
<b>Content:</b>	BatDisconnect	<ul style="list-style-type: none"> <li>• Check whether the battery is connected.</li> <li>• Check if battery wiring port is open circuited.</li> <li>• If the error/warning remains, please contact customer service.</li> </ul>
<b>Explanation:</b>	Battery Disconnect. (Battery voltage not identified)	
<b>Codes:</b>	03	<b>Solutions:</b>
<b>Content:</b>	Bat Under Vol	<ul style="list-style-type: none"> <li>• Checking system settings, re-power and restart.</li> <li>• Check if the grid power down. If so, waiting for the grid power up, the inverter will automatically charge.</li> <li>• If the error/warning remains, please contact customer service.</li> </ul>
<b>Explanation:</b>	Battery voltage lower than normal range.	
<b>Codes:</b>	04	<b>Solutions:</b>
<b>Content:</b>	Bat Low capacity	Low battery setting capacity(SOC<100%-DOD)
<b>Explanation:</b>	Bat Low capacity	
<b>Codes:</b>	05	<b>Solutions:</b>
<b>Content:</b>	Bat Over Vol	<ul style="list-style-type: none"> <li>• Checking system settings, re-power and restart.</li> <li>• If the error/warning remains, please contact customer service.</li> </ul>
<b>Explanation:</b>	The battery voltage is over than the Inverter maximum voltage.	

<b>Codes:</b>	06 / 07	<b>Solutions:</b>
<b>Content:</b>	Gird low vol / over vol	<ul style="list-style-type: none"> <li>• Check if the grid is abnormal.</li> <li>• Restart the inverter and wait until it functions normally.</li> <li>• If the error/warning remains, please contact customer service.</li> </ul>
<b>Explanation:</b>	Grid voltage is abnormal.	
<hr/>		
<b>Codes:</b>	08 / 09	<b>Solutions:</b>
<b>Content:</b>	Gird lowFreq / overFreq	<ul style="list-style-type: none"> <li>• Check if the grid is abnormal.</li> <li>• Restart the inverter and wait until it functions normally.</li> <li>• If the error/warning remains, please contact customer service.</li> </ul>
<b>Explanation:</b>	Grid Frequency is abnormal.	
<hr/>		
<b>Codes:</b>	10	<b>Solutions:</b>
<b>Content:</b>	Gfci over	<ul style="list-style-type: none"> <li>• Check PV string for direct or indirect grounding phenomenon.</li> <li>• Check peripherals of inverter for current leakage.</li> <li>• If the error/warning remains, please contact customer service.</li> </ul>
<b>Explanation:</b>	Inverter GFCI exceeds standard.	
<hr/>		
<b>Codes:</b>	13	<b>Solutions:</b>
<b>Content:</b>	Bus under vol	<ul style="list-style-type: none"> <li>• Check the input mode setting is correct.</li> <li>• Restart the inverter and wait until it functions normally.</li> <li>• If the error/warning remains, please contact customer service.</li> </ul>
<b>Explanation:</b>	BUS voltage is lower than normal.	

<b>Codes:</b>	14	<b>Solutions:</b>
<b>Content:</b>	Bus over vol	<ul style="list-style-type: none"> <li>• Check the input mode setting is correct.</li> <li>• Restart the inverter and wait until it functions normally.</li> </ul>
<b>Explanation:</b>	BUS voltage is over maximum value.	

<b>Codes:</b>	15	<b>Solutions:</b>
<b>Content:</b>	Inv over cur	Restart the inverter and wait until it functions normally.
<b>Explanation:</b>	The inverter current exceeds the normal value.	

<b>Codes:</b>	16	<b>Solutions:</b>
<b>Content:</b>	Chg over cur	Restart the inverter and wait until it functions normally.
<b>Explanation:</b>	Battery charge current over than the Inverter maximum voltage.	

<b>Codes:</b>	18 / 19	<b>Solutions:</b>
<b>Content:</b>	Inv under vol / over vol	<ul style="list-style-type: none"> <li>• Check if the INV voltage is abnormal.</li> <li>• Restart the inverter and wait until it functions normally.</li> <li>• If the error/warning remains, please contact customer service.</li> </ul>
<b>Explanation:</b>	INV voltage is abnormal.	

<b>Codes:</b>	21	<b>Solutions:</b>
<b>Content:</b>	Igbt temp high	Disconnect all power from the inverter, wait one hour, and then turn on the power to the inverter.
<b>Explanation:</b>	The inverter temperature is higher than the allowed value.	

<b>Codes:</b>	20	<b>Solutions:</b>
<b>Content:</b>	InvFreqAbnor	<ul style="list-style-type: none"> <li>• Check if the INV frequency is abnormal.</li> <li>• Restart the inverter and wait until it functions normally.</li> <li>• If the error/warning remains, please contact customer service.</li> </ul>
<b>Explanation:</b>	INV frequency is abnormal.	

<b>Codes:</b>	23	<b>Solutions:</b>
<b>Content:</b>	Bat over temp	<ul style="list-style-type: none"> <li>• Disconnect the battery and reconnect it after an hour.</li> </ul>
<b>Explanation:</b>	Battery temperature is higher than the allowed value.	

<b>Codes:</b>	24	<b>Solutions:</b>
<b>Content:</b>	Bat UnderTemp	<ul style="list-style-type: none"> <li>• Check the ambient temperature near the battery to confirm it meets the specifications.</li> </ul>
<b>Explanation:</b>	Battery temperature is lower than the allowed value.	

<b>Codes:</b>	27	<b>Solutions:</b>
<b>Content:</b>	BMS comm.fail	<ul style="list-style-type: none"> <li>• Check the cable, RJ45 header, line sequence.</li> <li>• Checking the Battery switch.</li> </ul>
<b>Explanation:</b>	Communication between lithium battery and inverter is abnormal.	

<b>Codes:</b>	28	<b>Solutions:</b>
<b>Content:</b>	Fan fail	<ul style="list-style-type: none"> <li>• Check whether the Inverter temperature is abnormal.</li> <li>• Check whether the fan runs properly.( If you can see it)</li> </ul>
<b>Explanation:</b>	Fan fail	



<b>Codes:</b>	30	<b>Solutions:</b>
<b>Content:</b>	Grid Phase error	
<b>Explanation:</b>	<p>The power grid phase sequence is incorrectly connected.</p> <p>Check power grid wiring</p>	
<b>Codes:</b>	31	<b>Solutions:</b>
<b>Content:</b>	Arc Fault	<ul style="list-style-type: none"> <li>• Check Photovoltaic panels, PV wire.</li> <li>• If the error/warning remains, please contact customer service.</li> </ul>
<b>Explanation:</b>	<p>PV Arc Fault</p>	
<b>Codes:</b>	32 / 33	<b>Solutions:</b>
<b>Content:</b>	Bus soft fail / Inv soft fail	<ul style="list-style-type: none"> <li>• Restart the inverter and wait until it functions normally.</li> <li>• If the error/warning remains, please contact customer service.</li> </ul>
<b>Explanation:</b>	<p>The inverter may be damaged.</p>	
<b>Codes:</b>	33 / 34	<b>Solutions:</b>
<b>Content:</b>	Bus short / Inv short	<ul style="list-style-type: none"> <li>• Restart the inverter and wait until it functions normally.</li> <li>• If the error/warning remains, please contact customer service.</li> </ul>
<b>Explanation:</b>	<p>The inverter may be damaged.</p>	
<b>Codes:</b>	36	<b>Solutions:</b>
<b>Content:</b>	Fan fault	<ul style="list-style-type: none"> <li>• Check whether the Inverter temperature is abnormal.</li> <li>• Check whether the fan runs properly.( If you can see it)</li> </ul>
<b>Explanation:</b>	<p>Fan fault</p>	

---

<b>Codes:</b>	37	<b>Solutions:</b>
<b>Content:</b>	PV iso low	<ul style="list-style-type: none"> <li>• Check if the PE line is connected to the inverter and is connected to the ground.</li> <li>• If the error/warning remains, please contact customer service.</li> </ul>
<b>Explanation:</b>		
PV Low insulation impedance.		

---



---

<b>Codes:</b>	38	<b>Solutions:</b>
<b>Content:</b>	Bus Relay Fault	<ul style="list-style-type: none"> <li>• Restart the inverter and wait until it functions normally.</li> <li>• If the error/warning remains, please contact customer service.</li> </ul>
<b>Explanation:</b>		
The inverter may be damaged.		

---



---

<b>Codes:</b>	39	<b>Solutions:</b>
<b>Content:</b>	Grid Relay Fault	<ul style="list-style-type: none"> <li>• Restart the inverter and wait until it functions normally.</li> <li>• If the error/warning remains, please contact customer service.</li> </ul>
<b>Explanation:</b>		
The inverter may be damaged.		

---



---

<b>Codes:</b>	40	<b>Solutions:</b>
<b>Content:</b>	EPS rly fault	<ul style="list-style-type: none"> <li>• Restart the inverter and wait until it functions normally.</li> <li>• If the error/warning remains, please contact customer service.</li> </ul>
<b>Explanation:</b>		
The inverter may be damaged.		

---



---

<b>Codes:</b>	41	<b>Solutions:</b>
<b>Content:</b>	Gfci fault	<ul style="list-style-type: none"> <li>• Restart the inverter and wait until it functions normally.</li> <li>• If the error/warning remains, please contact customer service.</li> </ul>
<b>Explanation:</b>		
The inverter may be damaged.		

---

<b>Codes:</b>	44	<b>Solutions:</b>
<b>Content:</b>	Selftest fail	<ul style="list-style-type: none"> <li>Restart the inverter and wait until it functions normally.</li> <li>If the error/warning remains, please contact customer service.</li> </ul>
<b>Explanation:</b>	The inverter may be damaged.	

<b>Codes:</b>	45	<b>Solutions:</b>
<b>Content:</b>	System fault	<ul style="list-style-type: none"> <li>Restart the inverter and wait until it functions normally.</li> <li>If the error/warning remains, please contact customer service.</li> </ul>
<b>Explanation:</b>	The inverter may be damaged.	

<b>Codes:</b>	46	<b>Solutions:</b>
<b>Content:</b>	Current DCover	<ul style="list-style-type: none"> <li>Restart the inverter and wait until it functions normally.</li> <li>If the error/warning remains, please contact customer service.</li> </ul>
<b>Explanation:</b>	The inverter may be damaged.	

<b>Codes:</b>	47	<b>Solutions:</b>
<b>Content:</b>	Voltage DCover	<ul style="list-style-type: none"> <li>Restart the inverter and wait until it functions normally.</li> <li>If the error/warning remains, please contact customer service.</li> </ul>
<b>Explanation:</b>	The inverter may be damaged.	



If an error occurs that is not listed in the table, please contact customer service.



SHENZHEN MEGAREVO TECHNOLOGY CO., LTD.

---



Building 2, Winlead, Shutianpu Community, Matian Street, Guangming District,  
Shenzhen City, Guangdong Province, P.R. China

T: +86 0755 2138 0136

M: [sales@megarevo.com.cn](mailto:sales@megarevo.com.cn)

WEBSITE: [www.megarevo.com](http://www.megarevo.com)