

OmySalon Waiting Room Bench Assembly Instruction

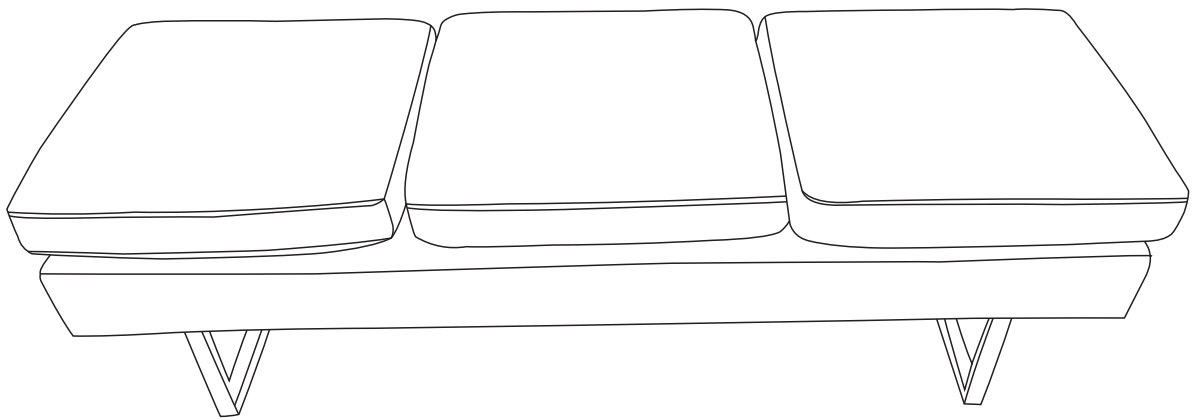

Thanks for your purchase. We hope you love it!

If you enjoyed your shopping experience, tell us (and others) about it! You could post an online review.





This helps us to continue providing great products.

Thanks in advance! If anything we could do better, kindly email us and we'll try hard to solve the issue for you.

Email: support@omysalon.com,

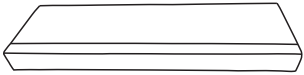
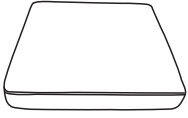
website link: www.omysalon.com

(Please kindly provide order number when you contact us.)

NO	PARTS	QTY	DESCRIPTION
A		1 PC	Seat frame
B		3 PCS	Seat Cushion
C		2 PCS	Leg
D		8 PCS+2	M8*50mm Screw
E		8 PCS+2	M8*22 Flat Washer
F		1 PC	Allen Key

STEP 1

Secure the Leg C and Seat frame A with screw D

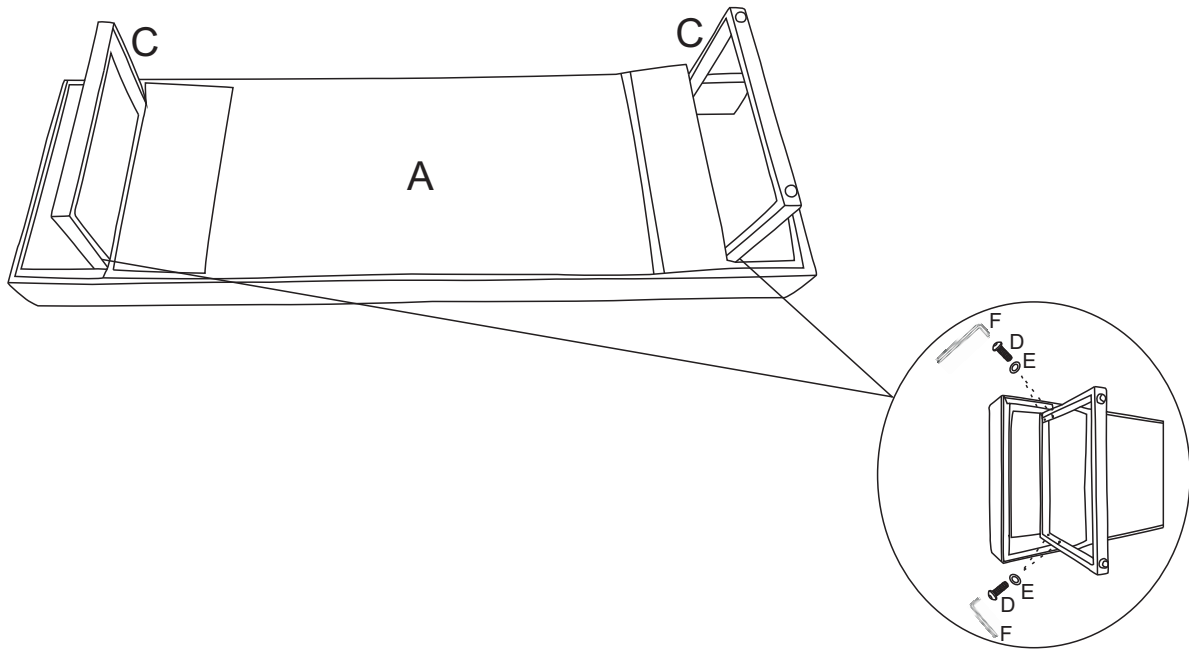

STEP 2

Have cushion B placed respectively

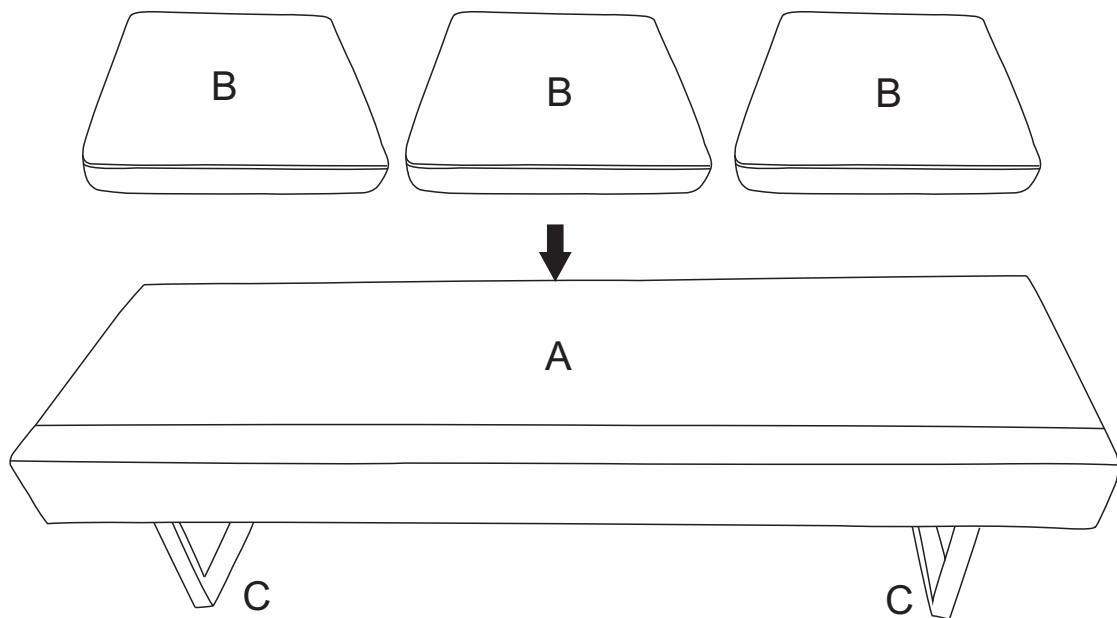

STEP 3

Well done!

