

# OmySalon

**Salon Chair**  
**Model: SC04-B**



Visit our website: [www.omysalon.com](http://www.omysalon.com)

For missing parts or questions: email us at [support@omysalon.com](mailto:support@omysalon.com)

## Part List

1

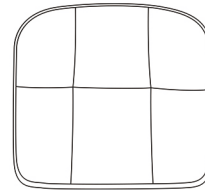

Seat(X1)

2

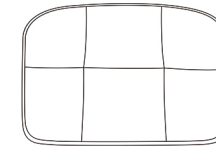

Backrest(X1)

3

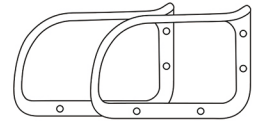

Armrest(X2)

4

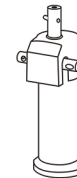

Hydraulic pump(X1)

5

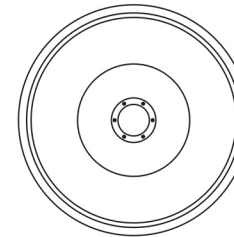

Base(X1)

6

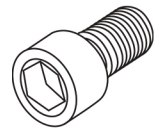

Screws for pump(X6)

7



Cover for screws(X8)

8

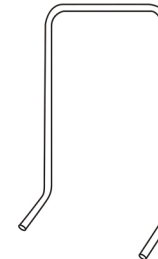

Footrest(X1)

9



Pump lever(X1)

# Assembly Direction

## STEP 1: Set up chair base

- Need #4,#5,#6,#9
- Align pump and base, screw in 6 screws. when screwing in the bolts for pump, please don't tighten screws at once, leave some space for adjustment.
- Loosen built-in screws half way, put lever and then tighten the screws.

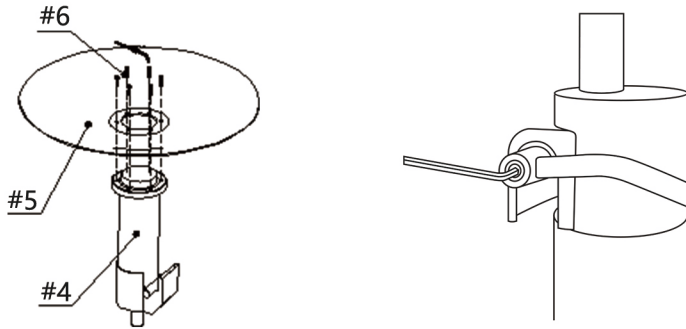

Pay attention to the direction of pump lever. If you need to push up lever instead of step down to raise chair, that means you assemble in a wrong way.

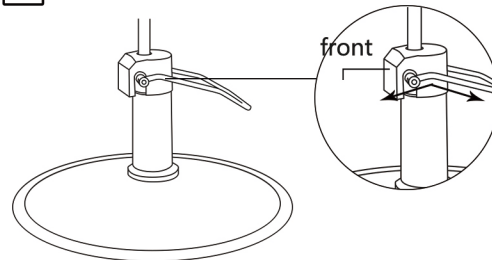
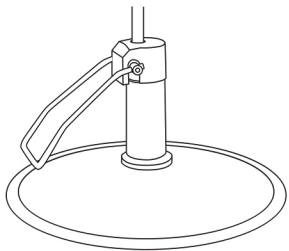

## STEP 2: Set up upper part

- Need #1,#2,#3,#7
- Put chair seat. Make sure that slot under seat is line up with pump.

3

- Screw out 8 screws for armrest first. Connect armrest to cushioned seat by locking 4 screws halfway. And then connect backrest by locking the other 4 screws. In order to adjust the position of barber chair better, please don't screw them tightly at first.



The armrests are marked with R/L. When you sit on chair, R is at right side.

## STEP 3: Set up footrest

- Need #8
- Loosen 2 screws for footrest first, put the footrest and screw in the screws.

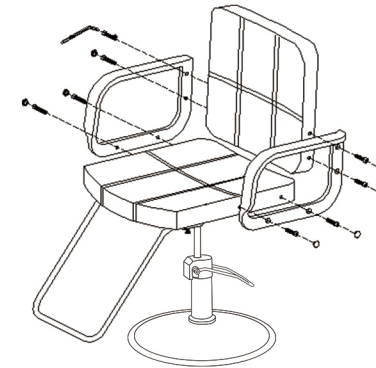

✉ EMAIL

🌐 WEBSITE

⚠ IMPORTANT

support@omysalon.com

www.omysalon.com

Any questions please feel free to email us with order ID included so that we can better help you.

4