

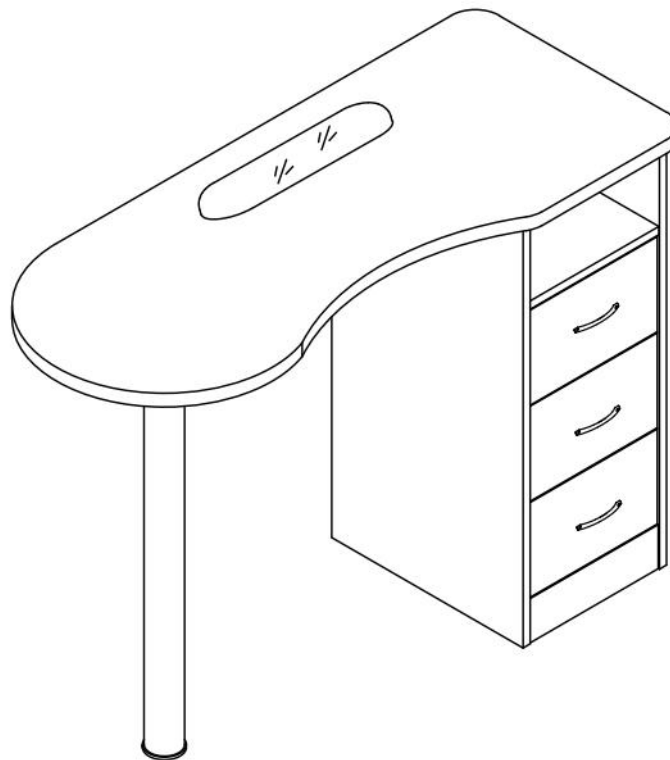

Wooden Manicure Table











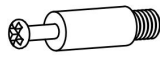

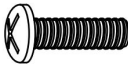
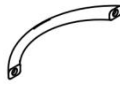
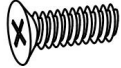
Instruction

(Model No. WMT-SC)

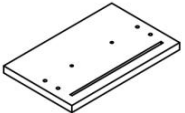
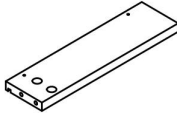
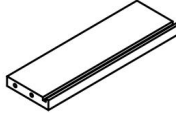
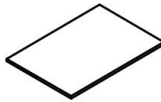
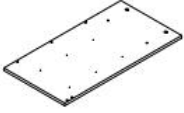
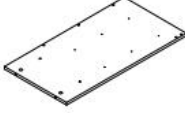

Thank you for your purchase. If you have any problem, please feel free to contact us by sending an email to support@Omysalon.com. We will work out an appropriate solution for you asap. And your suggestions will be helpful for our future improvement in product and service. (Please include order# in the email subject so that we can get details about the order and the product you are inquiring about.)

● PARTS

<p>A × 46</p>  <p>Ø7*35</p>	<p>B × 46</p>  <p>Ø15*12</p>	<p>C × 6</p>  <p>M4*20</p>	<p>D × 3</p> 	<p>E × 32</p>  <p>M4*12</p>
<p>F × 3</p> 	<p>G × 1</p> 	<p>H × 1</p>  <p>Ø50*763</p>	<p>I × 1</p>  <p>M10*30</p>	<p>N × 3</p>  <p>266*172*15</p>
<p>O × 6</p>  <p>300*116*15</p>	<p>P × 3</p>  <p>214*116*15</p>	<p>Q × 3</p>  <p>223*295*5</p>	<p>R × 1</p>  <p>771*400*15</p>	<p>S × 1</p>  <p>771*400*15</p>
<p>T × 1</p>  <p>398*270*15</p>	<p>U × 1</p>  <p>605*270*15</p>	<p>V × 1</p>  <p>270*80*15</p>	<p>W × 1</p>  <p>1100*450*25</p>	<p>X × 1</p> 

● ASSEMBLY ILLUSTRATION

Tip:

1. It is suggested not to fully tighten the screws and eccentric wheels until all the steps have been done and parts are installed correctly.
2. Tools that may be needed for assembly: screwdriver and power drill.
3. Drawer slides are kind of oily. If you want to keep your hands clean, you can wear gloves.

Step 1 Assemble Drawers

Extend the drawer slide and press the release lever to separate the inner rail from the outer rail. And put the outer rail (that will be installed to the side panel of the cabinet) aside.

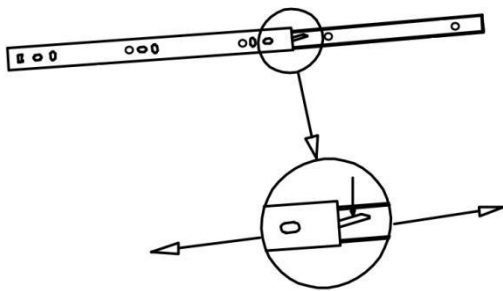

Locate all the panels for drawers and secure the dowels to pre-inserted nuts on the front panel and side panels first. And then mount the inner rails of the drawer slides to the side panels with screws.

Line up the dowels on the front panel with the holes on the side panels and push them into the holes. Put the eccentric wheels into the holes on the side panels.

Install the bottom panel and the back panel. Put the eccentric wheels into the holes on the back panel.

Tighten all the eccentric wheels with your screwdriver and install the handle to the front panel. Then a drawer is done. Assemble other drawers in the same way.

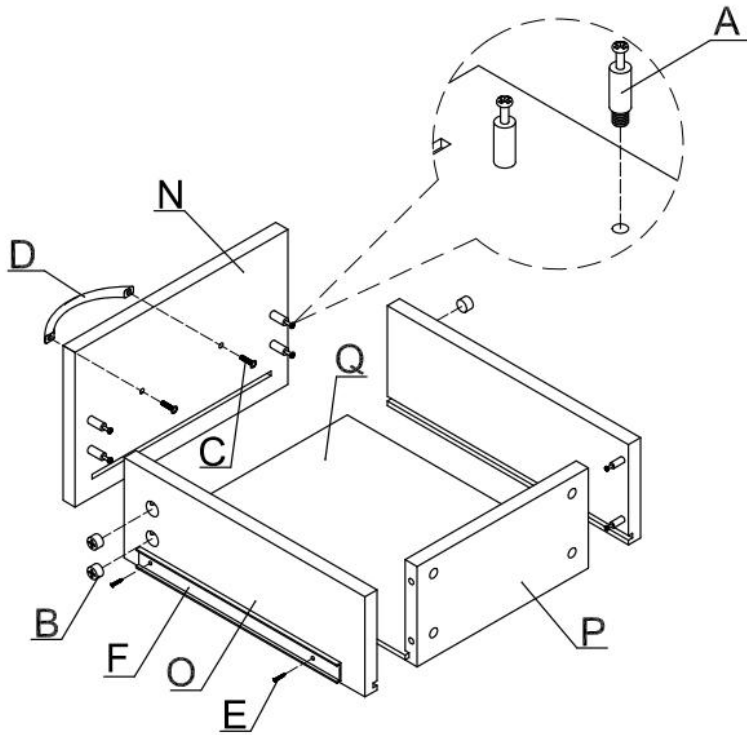

Step 2 Assemble the Cabinet

Install the dowels to the pre-inserted nuts on the top panel. Align the dowels on the top panel with the holes on the back panel and push them into the holes. Put the eccentric wheels into the holes on the back panel and tighten them with your screwdriver.

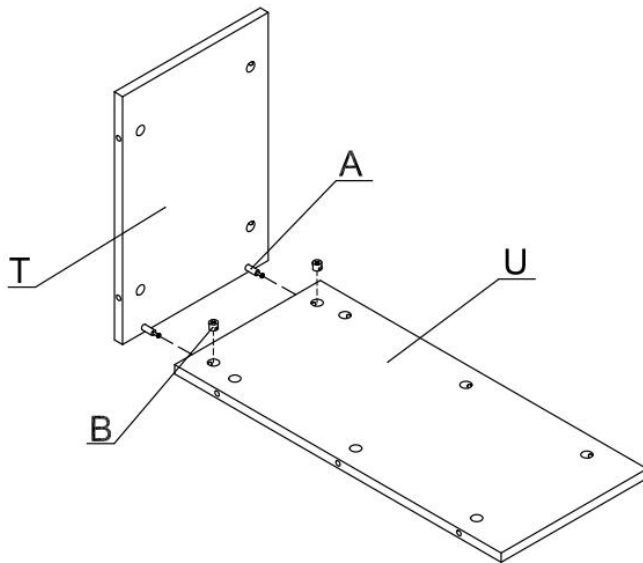

Line up the holes on the outer rails of drawer slides with the holes on the side panels and then mount the outer rails to the side panels with screws.

Locate side panels and panel V. Install the dowels to pre-inserted nuts on the side panels. Align the dowels with the corresponding holes on the top panel, back panel and panel V and push them into the holes. Put the eccentric wheels into the corresponding holes and tighten them with your screwdriver.

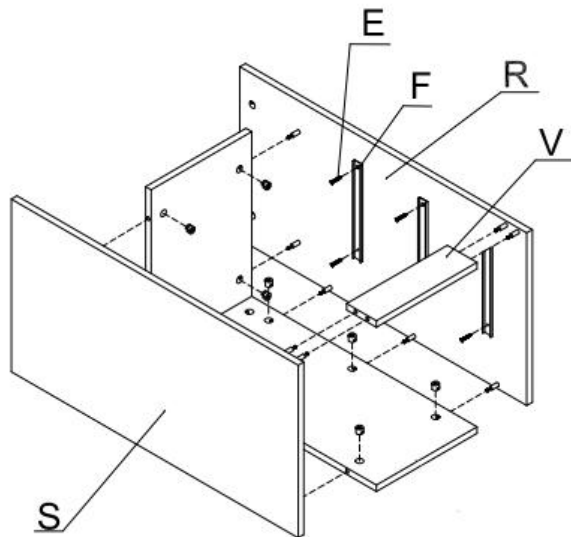

Step 3 Install the Supporting Tube

Secure the metal plate to the bottom of the tabletop with screws. Turn the screw (Part I) to tighten part of the screw into the supporting tube first. Then put the screw into the hole on the bottom of the tabletop and turn the supporting tube to secure it to the tabletop.

Install the dowels to the pre-inserted nuts on the bottom of the tabletop. Prepare for the next step.

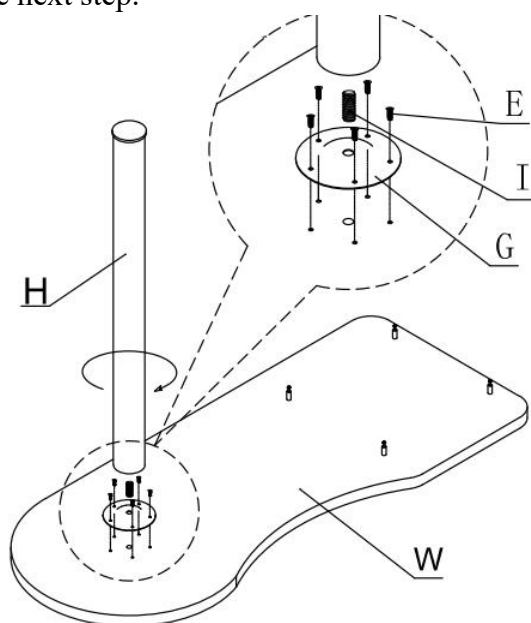

Step 4 Connect the Tabletop to the Cabinet

Line up the dowels on the bottom of the tabletop with the holes on the top of the side panels and push them into the holes. Put the eccentric wheels into the holes on the side panels and tighten them.

Push the drawers into the cabinet. Then a manicure table is done.

