



SKYLINE

OPULENCE MASSAGE CHAIR

OPERATION INSTRUCTIONS

SAVE THESE INSTRUCTIONS

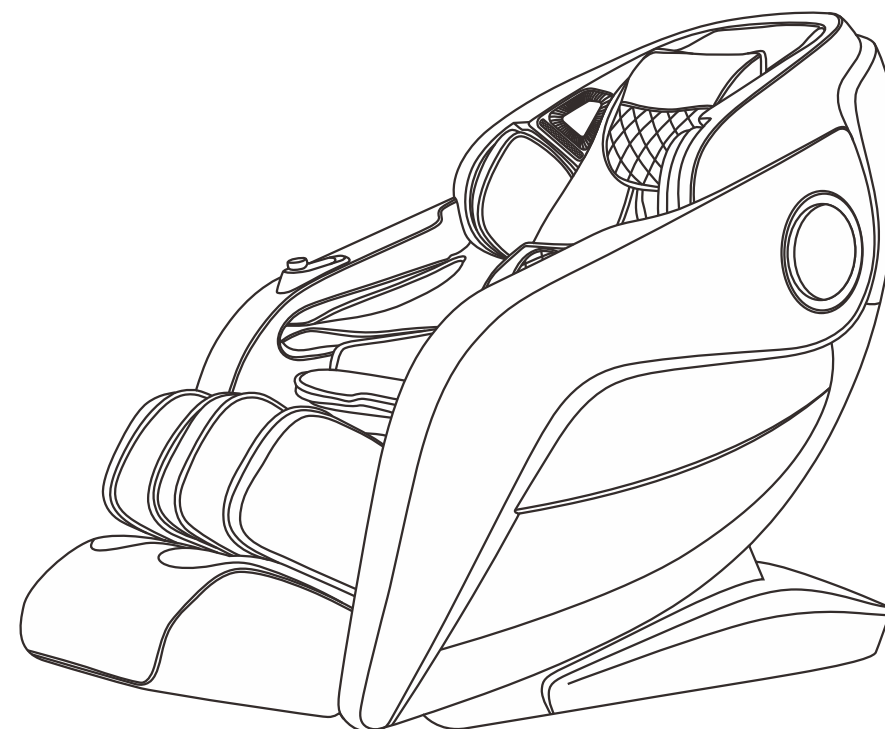

IQ Technologies Inc
4731 West Post Road unit 130
Las Vegas NV 89118
USA: 702-260-8829
WWW.IQSKYLINE.COM

Thank you for purchasing this product. Before you use it, please read the Operation Instructions in detail for the correct usage of this product, especially the important safety warnings. Keep the Operation Instructions properly for future reference.

Note: iRest reserves the right to change and explain any product design without prior notice. Product colors are subject to the actual products.

TABLE OF CONTENTS

Safety and Maintenance	02-03
Safety Warning	04-05
Name of Components	06
Function	07
Introduction to the Remote Controller	08-09
Method of Usage	10-36
I.Turn on the power supply of this product	10
II.Message Function Control Operation	10
III.Introduction to Armrest Shortcut Keys	28-29
IV.Voice Control Instruction	30
V.Turn off the Power and Stop Massage	31
VI.Operation Instructions for Bluetooth Speaker Play	31
VII.Installation Instructions for Armrests	31
VIII.nstallation Instructions for Legrest	33
IX.Instructions for Removal and Use of Head Cushion and Backrest	35
X.Floor Protection	36
XI.Instruction for Movement	36
Product Specification	37

Safety and Maintenance

1. Important Safety Warnings

- Do not allow children to touch any movable part of this product.
- Use the well-grounded power supply unit suitable for this product.
- Pull out the plug after use or before cleaning to avoid any physical injury or damage to the product.
- Operate this product as instructed in this manual.
- Do not use any parts or accessories which are not recommended.
- Do not use this product outdoors.
- Please read the Operation Instructions carefully before operation.
- Never use this product for any other purpose not listed herein.
- 20 minutes of usage each time is recommended.
- Do not use this product if the leather is broken or damaged.
- Do not use this product if the cover or leather is broken or damaged.
- Do not use this product if the radiator hole is covered or blocked.
- Do not drop anything into this product.
- Never fall asleep while using this product.
- Do not use this product if you are drunk or feel unwell.
- Do not use this product within one hour after a meal.
- Do not use this product with excessive force to avoid any injury.
- Do not carry any fragile, explosive, or combustible material in your pocket, such as a mobile phone and lighter when using the massage chair.

2. Operating Environment

- Do not use this product in a very moist environment such as the bathroom.
- Stop using this product immediately when the ambient temperature changes sharply.
- Do not use this product in any heavily-dusty or caustic environment.
- Do not use this product in a small space or a place without good ventilation.
- The normal room temperature ranges from 0 °C to 35 °C.
- Do not use this product in an excessively humid room such as a bathroom. Use it at a relative humidity between 20% and 80%.
- Do not use this product outdoors.
- Avoid direct sunlight.
- Keep this product away from any heat source such as a stove and air outlet of an air conditioner.
- Do not use this product during thunder or lightning weather.
- Do not use this product in dusty places.

3. The following populations should not use this product

- Patients with osteoporosis.
- Patients with heart disease or wearing electronic medical devices such as a pacemaker.
- People who have a fever.
- Pregnant women or women on their menstrual period.
- Patients who are injured or have a skin disease.
- When unsupervised, any children are under the age of 14 and those unconscious are not allowed to use this product.
- People who are told by their physicians to have rest or who feel unwell.
- People whose bodies are wet are forbidden to use this product.
- This product has a hot surface. Persons insensitive to heat must pay attention when using this product.

Safety and Maintenance

4. Safety Precautions

- Check whether voltage is consistent with the specification of this product.
- Never insert or pull out the plug with a wet hand.
- Do not let water flow into this product to avoid electric shock or cause damage to this product.
- Do not pull the power cord when plugging or unplugging it. Rough handling is forbidden.
- Do not damage the wire or modify the circuit of this product.
- Do not clean live parts of this product with a wet cloth such as a power switch and plug.
- Be away from this product in case of power failure to avoid any injury if power is restored suddenly.
- Stop using this product at once while it works abnormal, and consult your local supplier.
- Stop using this product if you feel unwell, and consult your health care practitioner.
- This product is not intended for use by persons (including children) with reduced physical, sensory or mental capabilities, or lack of experience and knowledge, unless they have been given supervision or instruction concerning the use of this product by the personnel responsible for their safety. Children should be supervised to ensure that they do not play with this product.
- If the power cord is damaged, it must be replaced by the manufacturer, its service agent or similarly qualified staff in order to avoid hazards.

5. Product Service and Maintenance

- This product should be maintained by the service center designated by the manufacturer only. No user should disassemble or maintain it without permission.
- Do not forget to turn off the main power switch after usage.
- Do not use this product if the power socket becomes loose.
- If this product will be left unused for a long period of time, it is necessary to roll up the power cord of this product and store this product in a dry and dust-free environment.
- Do not store this product at a high temperature or near open flame. Avoid prolonged exposure to direct sunshine.
- Please clean this product with dry cloth. Never use thinner, benzene or alcohol.
- The mechanical components of this product are specially designed and manufactured, so no special maintenance is needed.
- Do not use a sharp object to stab at this product.
- Do not roll or pull this product on any uneven ground. Instead, it should be lifted before moving.
- Please use this product intermittently. Do not keep it working continuously for a long period of time.

6. Solutions to Ordinary Malfunctions

- If the motor sounds during operation of this product, this is the normal operation sound.
- If the controller cannot work normally, check whether the plug and the power socket are connected reliably, and whether the power switch is turned on.
- If the rated working time is over, this product will automatically activate the power-off button; If this product keeps operating for a long period of time, the temperature protector will stop this product automatically. The product can be used again after half an hour.

7. Storage Conditions

- Storage room temperature: -5 °C to 35 °C.
- Relative humidity (RH) between 20% and 80%; free of corrosive gases, and a well-ventilated room.

Safety Warning

⚠ Warning

When the legrest of the massage chair is lifted, nobody should apply pressure on the legrest to prevent the massage chair from falling forward which will damage this product or result in personal injuries.

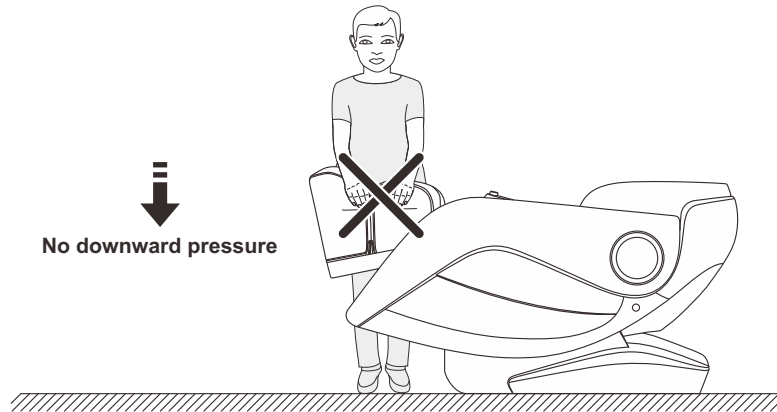

⚠ Warning

Before sitting on the massage chair, make sure that the massage chair manipulator does not stay in the seat cushion position to avoid discomfort to the buttocks during the body pressing down and any damage to the massage chair manipulator.

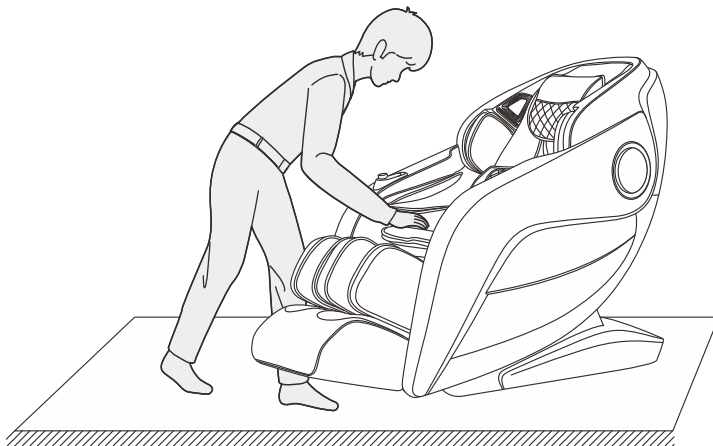

04

Safety Warning

⚠ Warning

Do not remove or pull out the remote controller cable or the power cord in the standby or power-on state to avoid any damage to this product or accidental electric shock of a body part. You are advised to unplug the remote controller cable and the power cord and put them away after you use the massage chair.

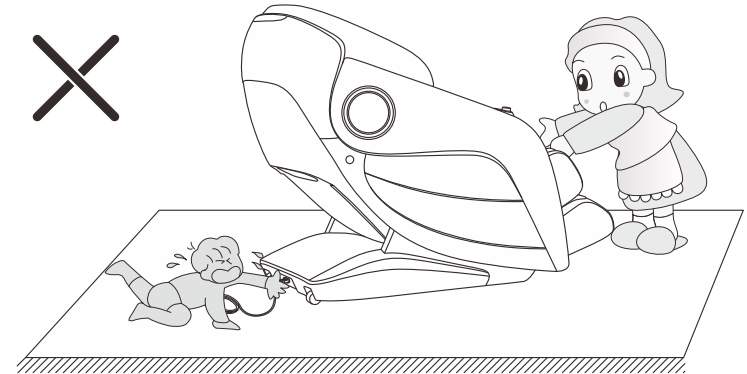

⚠ Warning

When the zero-gravity lying function is enabled, be sure to check whether there is any child or pet staying or playing under the bottom of the legrest and backrest, in order to avoid any damage to this product or physical injury.

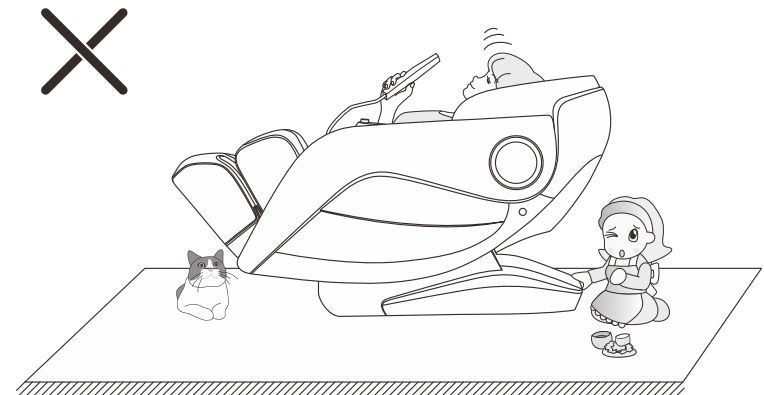

05

Names of Components

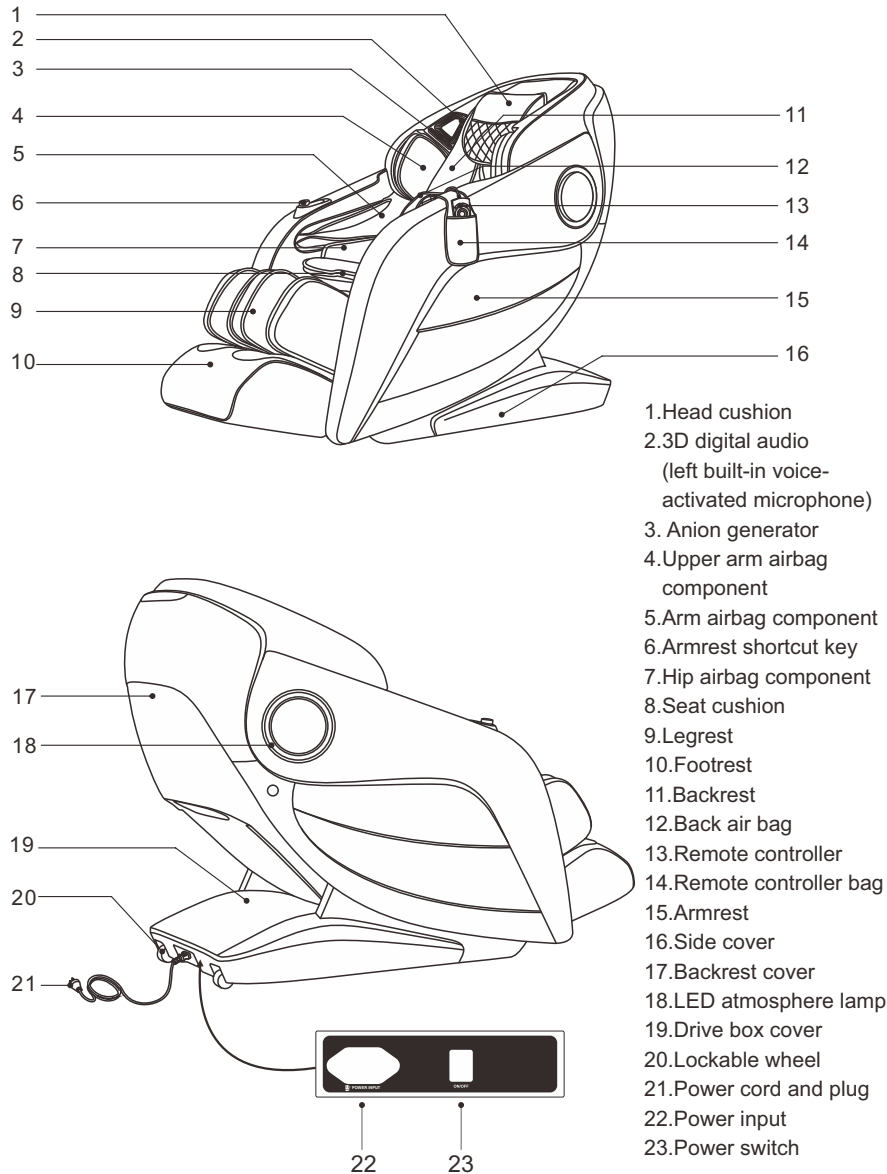

Function

- This product is designed with a set of 3D intelligent massage chair manipulators that can move up and down, extend from front to back and operate in mute mode.
- It is designed with automatic detection and micro-adjustment functions of the shoulder position, as well as automatic detection function of the human body curve and shiatsu massage points. Therefore, according to the detected human body curve and shiatsu massage points, it can automatically adjust the manipulators to extend from front to back, making the massage more user-friendly and scientific.
- Eight special automatic massage functions are available: fast massage, comfortable massage, relaxing massage, stretching massage, full body massage, neck & shoulder massage, back & waist massage, and full airbag massage.
- There are three intelligent memory functions: Custom Storage I, Custom Storage II, and Custom Storage III.
- Manually select the massage function for the upper body; there are five options of massage positions (i.e. full range, local, fixed point, upper back, and lower back), as well as six massage techniques (i.e. shoulder lifting, kneading, tapping, shiatsu, simultaneous kneading and tapping, and 3D). For each massage technique, five speed levels can be switched; during massage in the state of tapping and shiatsu, the massage balls of manipulators have five width levels for switching.
- The airbag massage function is available: airbag massage function for the arms (8 built-in air bags), and airbag massage function for the upper arms (4 built-in air bags); and there are three levels of air pressure intensity for adjustment.
- Airbag massage function for the lower part; airbag massage function for the waist (4 built-in air bags); airbag massage function for the legs (26 built-in air bags, including the leg side); airbag massage function for the feet (22 built-in air bags); and there are three levels of air pressure intensity for adjustment.
- This product is equipped with the heat treatment function for the back and legs: carbon fiber is used as far infrared heat source.
- The slide rail technology for the backrest ensures zero space between the backrest and wall, so as to save the space to the greatest extent.
- The backrest guide adopts the curve guide technology, so it completely fits the curve of human back. The full body can enjoy full massage from the head to the thighs.
- This product is equipped with the intelligent voice control and recognition function (i.e. built-in voice-activated microphone for the left speaker).
- The music player system is available. 3D digital audio systems are built into the left and right upper arms. The Bluetooth function of the smart device can be used to play music wirelessly.
- This product is equipped with the waist massage function: use the air pressure on the waist to swing around for the waist massage, so as to relieve the tension of the waist muscles caused by prolonged sitting.
- The right armrest is provided with the feet stretching key, linkage lying key, heat treatment key, anion key, voice button, AUTO key, zero gravity key, ON/OFF (pause) key, 3D massage intensity and other shortcut keys.
- The massage chair is equipped with the independent up/down adjustment function of the legrest, the linkage up/down adjustment function of the backrest, and the zero-gravity automatic lying angle adjustment function.
- The foot roller massage function is available for the feet bottoms. Two sets of rollers roll to massage the roots of the toes; rolling and scraping massage is available for the foot arch.
- The footrest can perform automatic detection of the footrest length. When the legrest is raised or lowered to a suitable angle, the footrest will automatically detect the length of the feet and identify the most comfortable massage area.
- The left and right armrests are equipped with LED atmosphere lamps.
- The right armrest is equipped with an anion generator.
- Such functions as shutdown, automatic sitting up, and automatic manipulator resetting are available
- The product has a remote controller with TFT color screen.

Introduction to the Remote Controller

Remote Controller Interface

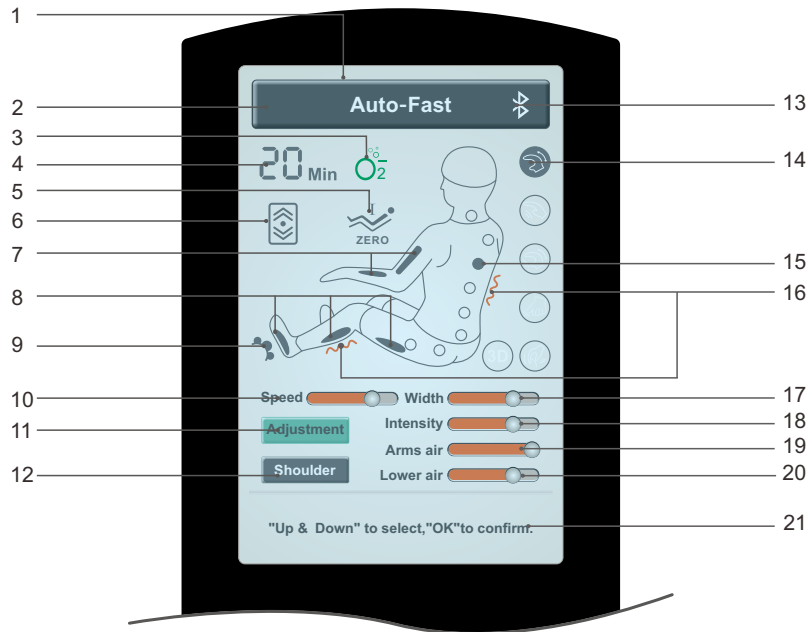

Note: The controllerremote controller displays the colors, massage functions and massage function icon layout order. Please refer to the physical display!

- | | |
|---|--|
| 1. TFT color LCD | 12. Shoulder position adjustment |
| 2. Massage function status bar | 13. Bluetooth display |
| 3. Anion generator display | 14. Massage mode display |
| 4. Time display | 15. Massage position display |
| 5. Zero gravity display | 16. Heat treatment display for the legs and back |
| 6. Back stretching display | 17. Width adjustment |
| 7. Air pressure display for the arms | 18. Massage intensity adjustment |
| 8. Air pressure display for the legs and feet | 19. Air pressure adjustment for the arms |
| 9. Foot roller display | 20. Air pressure adjustment for the lower body |
| 10. Speed adjustment | 21. Information bar |
| 11. Adjustment | |

Introduction to the Remote Controller

Remote Controller Buttons

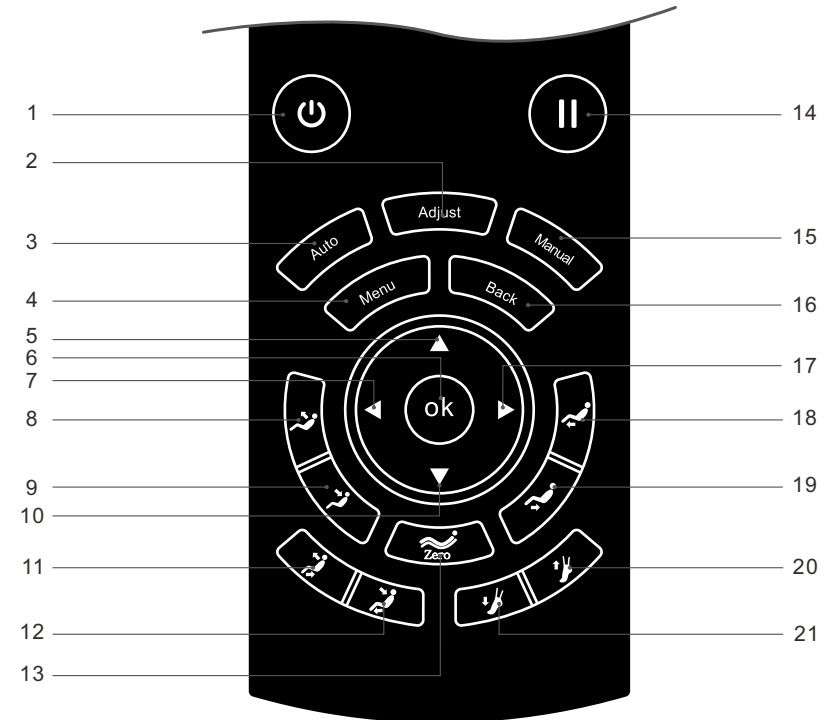

- | | |
|--|---|
| 1. Power button: Turn on or off the massage chair. | 12. Lying button: Linkage lying of the massage chair |
| 2. Adjustment button: Enter the adjustment function selection interface. | 13. Zero-gravity key: press it to adjust the massage chair to the angle for zero gravity. |
| 3. AUTO button: Enter the automatic mode selection interface. | 14. Pause button: Pause the current function. |
| 4. Menu button: Enter main menu interface. | 15. Manual button: Enter the manual mode selection interface. |
| 5. UP button: UP navigation key | 16. Back button: Return to the function information interface. |
| 6. OK: confirmation key | 17. Right button: Right navigation key |
| 7. Left button: Left navigation key | 18. Legrest up button: Adjust the legrest upward. |
| 8. Backrest up button: Adjust the backrest upward. | 19. Legrest down button: Adjust the legrest downward. |
| 9. Backrest Down button: Adjust the backrest downward. | 20. Footrest retraction button: Retract the footrest. |
| 10. Down button: Down navigation key | 21. Footrest extension button: Extend the footrest. |
| 11. Sitting button: Linkage UP of the massage chair | |

Method of Usage

I. Turn on the Power Supply of this Product

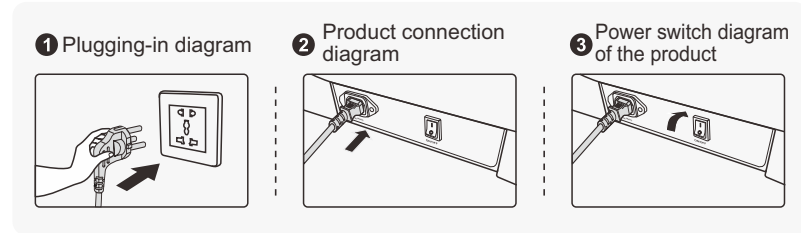

II. Massage Function Control Operation

1. Standby

After the massage chair is powered on or turned off or when it is in standby mode, it cannot enter any mode of operation, except the settings.



2. Start massage (power switch)

Press the power switch to start massage. Enter the start-up screen. The backrest will maintain the default position, and the legrest will be slightly raised. Just wait for the automatic mode to start massage. If "AUTO" mode is not selected within 5 minutes, the massage chair will automatically shut down.

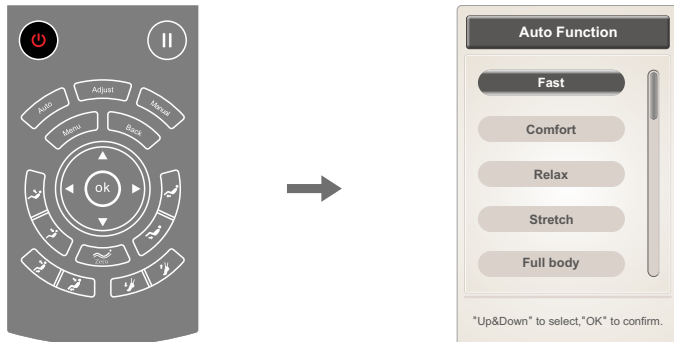

Method of Usage

- After selecting any automatic mode, the positions of the backrest and the legrest will be adjusted to the preset angles.
- After the angle is adjusted, the massage chair will automatically perform the shoulder position and body shape detection (Note: the fast massage function can only detect the shoulder position, and other modes are for full body shape and shoulder position detection). Wait for completion of such detection. By pressing "OK," you can skip such detection. The default value will be adopted automatically to start massage.

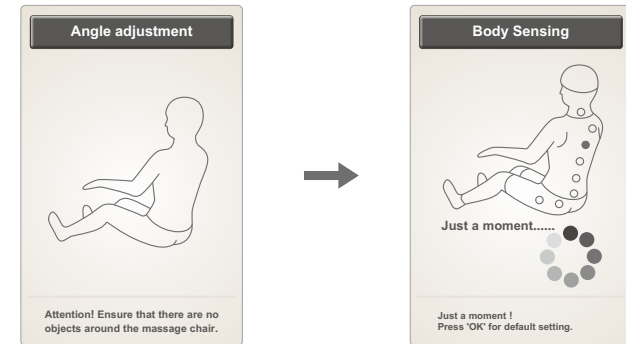

- After detecting the shoulder position, the buzzer will beep. If there is any difference from the actual shoulder position, adjust it to the appropriate position by pressing the "UP" or "DOWN" key. The shoulder position has 11 adjustable levels. If there is no shoulder position adjustment within 10 seconds, the massage function will start automatically. Alternatively, press "OK" directly to start massage immediately. If no shoulder position can be detected, massage will be started according to the shoulder height by default.

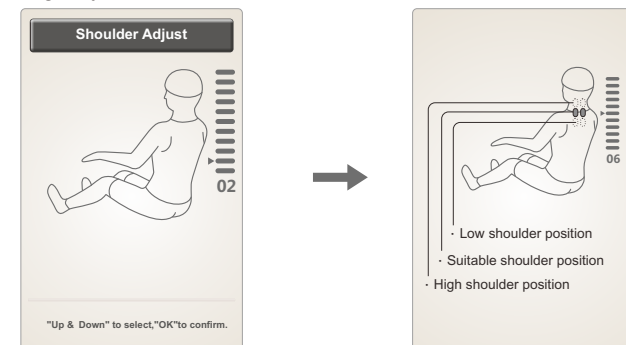

Button	Description
	Move the massage balls upward to a suitable shoulder position.
	Move the massage balls downward to a suitable shoulder position.

Method of Usage

- If you need to adjust the shoulder position after the massage program is started, you can direct select the shoulder position button in the operating status information interface to enter the shoulder position adjustment interface.

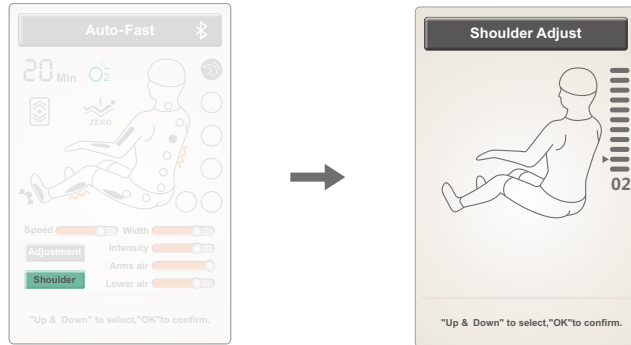

3. Pause button

- While the massage function is running, press the "Pause" button to temporarily stop all the massage functions; press the "Pause" button again to continue the massage function before pause. If the pause time exceeds 20 minutes, all the massage functions will be automatically turned off.

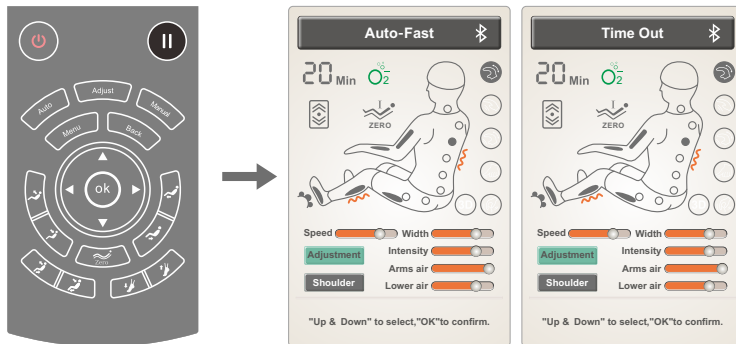

4. Menu

- Press the "Menu" button to enter the main menu message function selection interface, including: automatic function, manual mode, adjustment, customize, settings, and equipment information function interface.
- Press the "UP/DOWN" button for menu selection. Then press "OK" to enter the menu selected. Press the "Back" button to return to the selected function operation status information interface.

Method of Usage

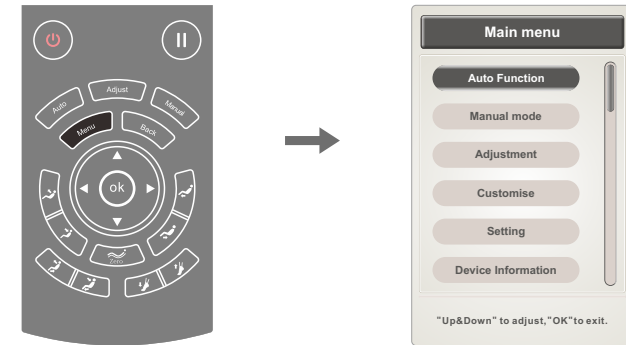

5. Automatic function (AUTO key: You can also press the "AUTO" key directly to enter the automatic function interface.)

- Press the "Menu" button to enter the main menu interface, and select the automatic function icon: The automatic mode consists of fast massage, comfortable massage, relaxing massage, stretching massage, full body massage, neck & shoulder massage, back & waist massage, and full airbag massage modes.
- Press the "UP/DOWN" button to choose the massage function. Press "OK" to confirm that you have entered the massage function menu selected. Press the "Back" button to return to the selected function operation status information interface.

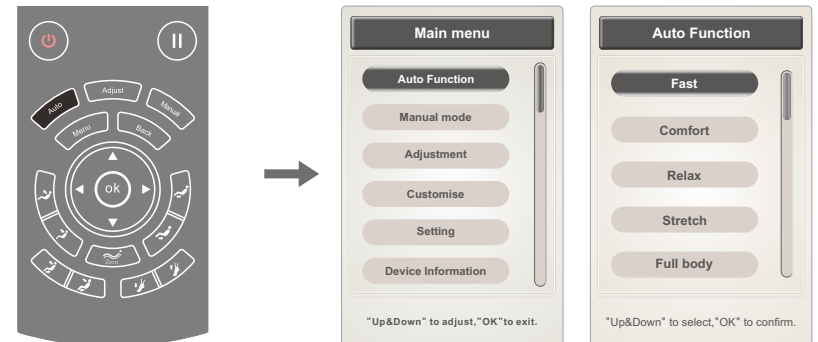

Note: The automatic function already selected will be displayed in the massage function status bar. You can directly press the "Back" button to view the operating status.

Method of Usage

Function	Description
Fast massage	Experience all the massage effects quickly.
Comfortable massage	The most comfortable massage experience.
Relaxing massage	Gentle and comfortable deep massage to relieve your body fatigue and relax the body.
Stretching massage	Stretch your legs and waist through the up/down movement of the legrest and the backrest and the waist swinging to effectively remove fatigue, relieve joint pain and restore vitality.
Full body massage	Deep massage to rejuvenate your body.
Neck & shoulder massage	With the unique massage technique for the neck and shoulder, the effective massage for the cervical spine and scapula can be performed to relieve the neck and shoulder pain and reduce fatigue on the neck and shoulder.
Back & waist massage	Focus on the back and waist massage to relieve the pain on the back and waist.
Full airbag massage	It focuses on the upper arms, arms, knees, legs and feet to relax your whole body.

6. Manual mode (Manual button: You can also press the "Manual" button directly to enter the manual mode interface.)

- Press the "Menu" button to enter the main menu interface, and select the manual mode icon: including massage technique, massage part, airbag massage, and other massage functions.
- Press the "Left" or "Right" button to switch among the submenus. Then press the "UP" or "DOWN" button to select the massage function. Press the "Back" button to return to the operating status information interface.

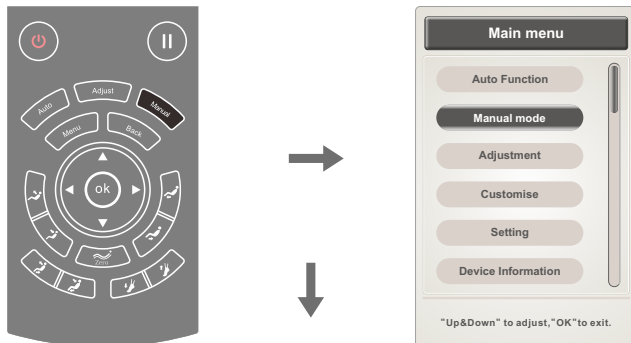

Method of Usage

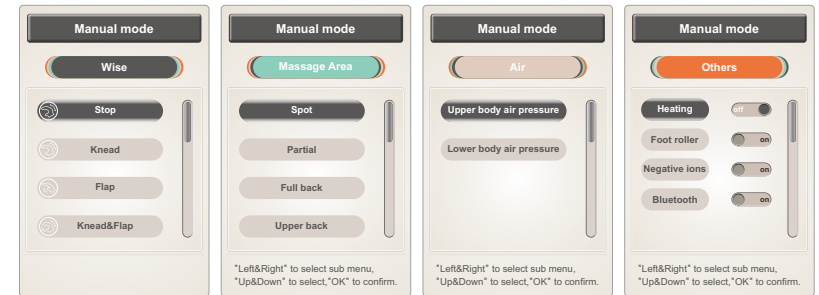

01. Manual mode (manual button - massage techniques)

- Manual (massage technique): six different massage techniques, including kneading, tapping, simultaneous kneading and tapping, shiatsu, 3D, and shoulder lifting. In the massage state of tapping and shiatsu, the massage ball width of each manipulator is adjustable. The massage speed is adjustable in other massage modes except the stop mode.
- Press the "UP/DOWN" button to select the massage technique icon. Then press "OK" to confirm that the massage technique will be applied.

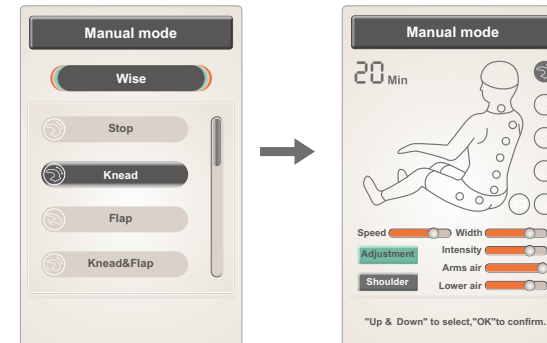

Note: Selecting the stop icon will stop all the massage technique functions of the method; selecting a massage technique icon will enable the individual massage technique.

Function	Description	
Kneading	Speed	5 speed levels adjustable 5 width levels adjustable
Tapping	Speed,width	
Simultaneous kneading and tapping	Speed	
Shiatsu	Speed,width	
Shoulder lifting	Speed	
3D	Speed,width	

Method of Usage

02).Manual mode (manual button - massage part)

- Manual mode (massage part): including such massage functions as fixed point, local, full back, upper back, and lower back.
- Press the "UP/DOWN" button to select the area function icon. Then press "OK" to confirm the area selected.

Manual mode

Message Area

Spot

Partial

Full back

Upper back

Left&Right to select sub menu, *Up&Down* to select, *OK* to confirm.

Manual mode

15 Min

Speed Width Adjustment Intensity Arms air Shoulder Lower air

Up&Down to select, *OK* to confirm.

Manual mode

16 Min

Speed Width Adjustment Intensity Arms air Shoulder Lower air

Up&Down to select, *OK* to confirm.

Manual mode

17 Min

Speed Width Adjustment Intensity Arms air Shoulder Lower air

Up&Down to select, *OK* to confirm.

Manual mode

18 Min

Speed Width Adjustment Intensity Arms air Shoulder Lower air

Up&Down to select, *OK* to confirm.

Manual mode

19 Min

Speed Width Adjustment Intensity Arms air Shoulder Lower air

Up&Down to select, *OK* to confirm.

Fixed point state

Local state

Full back state

Upper back state

Lower back state

Function	Description	
Fixed point	Massage at fixed point	When choosing the fixed point and local massage technique, you can adjust the massage area by pressing the "UP/DOWN" button.
Local	Local round-trip massage in a small area	
Upper back	Round trip massage on the upper back	
Lower back	Round trip massage on the lower back	
Full back	Round trip massage on the full back	

Method of Usage

03).Manual mode (manual button - airbag massage)

- Manual mode (airbag massage): including airbag massage functions for the upper body and the lower body.
- Press the "UP/DOWN" button to choose different airbag massage functions. Press "OK" to confirm your choice.

Manual mode

Air

Upper body air pressure

Lower body air pressure

Left&Right to select sub menu, *Up&Down* to select, *OK* to confirm.

Manual mode

20 Min

Speed Width Adjustment Intensity Arms air Shoulder Lower air

Up & Down to select, *OK* to confirm.

Manual mode

20 Min

Speed Width Adjustment Intensity Arms air Shoulder Lower air

Up & Down to select, *OK* to confirm.

Function	Description
Airbag massage for the upper body	Enable or disable the airbag massage function for the upper body
Airbag massage for the lower body	Enable or disable the airbag massage function for the lower body

04).Manual mode (manual button - other massage functions)

- Manual mode (other massage functions): including such massage functions as heat treatment, foot roller, anion generator, and Bluetooth.
- Press the "UP/DOWN" button to choose the massage function. Press "OK" to enable or disable such massage function.

Main menu

Auto Function

Manual mode

Adjustment

Customise

Setting

Device Information

Up&Down to adjust, *OK* to exit.

Manual mode

Others

Heating off

Foot roller on

Negative ions on

Bluetooth on

Left&Right to select sub menu, *Up&Down* to select, *OK* to confirm.

Method of Usage

• Manual mode (other - heat treatment on the back)

- Click "OK" to enable or disable the heat treatment function; the back will become warmer after such heating for 3min.
- Press the "UP" or "DOWN" button to select other massage functions. Press the "Back" button to return to the operating status information interface.

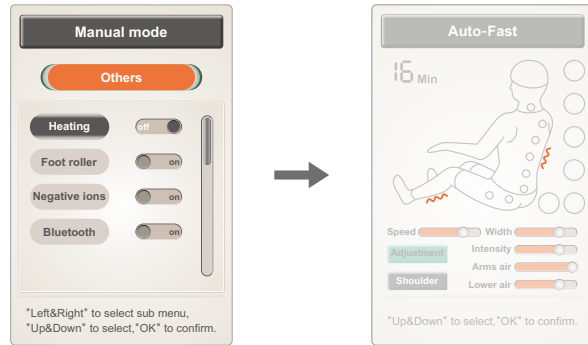

• Manual mode (other - foot roller)

- Press "OK" to enable or disable the foot roller massage function.
- Press the "UP" or "DOWN" button to select other massage functions. Press the "Back" button to return to the operating status information interface.

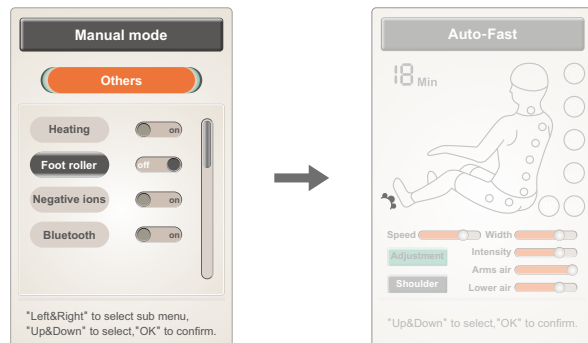

Method of Usage

• Manual mode (other - anion)

- Press "OK" to enable or disable the anion function.
- Press the "UP" or "DOWN" button to select other massage functions. Press the "Back" button to return to the operating status information interface.

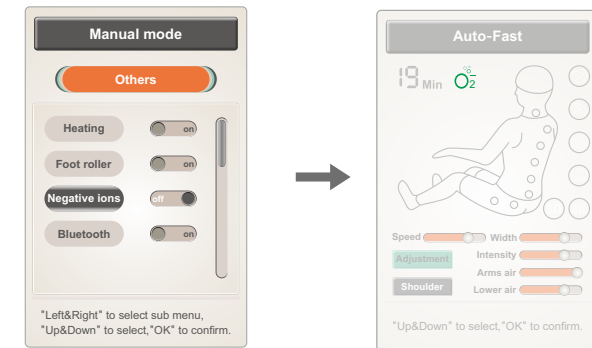

• Manual mode (other - Bluetooth)

- Press "OK" to enable or disable the Bluetooth function.
- After a Bluetooth-enabled audio source device (e.g. mobile phone, MID tablet) is connected with the Bluetooth module of the massage chair, the music played by the audio source device can be wirelessly transmitted to the audio system of the massage chair via Bluetooth for music playback.
- Press the "UP" or "DOWN" button to select other massage functions. Press the "Back" button to return to the operating status information interface.

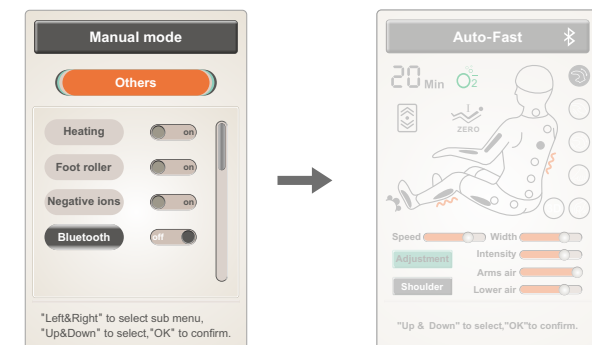

Method of Usage

7.Adjustment function (Adjustment button: You can also press the "Adjustment" button directly to enter the adjustment function interface.)

- Press the "Menu" button to enter the main menu interface, and select the adjustment function icon: including such massage functions as massage technique, massage area, and massage intensity (only timing available now).
- Press the "Left" or "Right" button to switch among the submenus. Select the massage function in the menu. Then press the "UP" or "DOWN" button to select the massage function to be adjusted. Press "OK" to confirm your choice, or press the "Back" button to return to the operating status information interface.

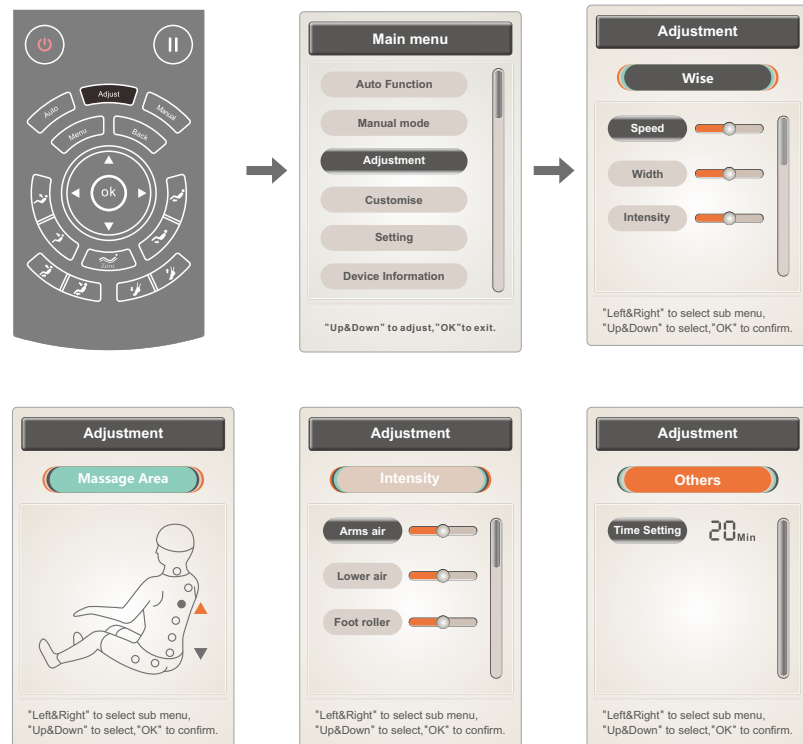

Alternatively, directly select the adjustment button in the operating status information interface to enter the adjustment interface.

Method of Usage

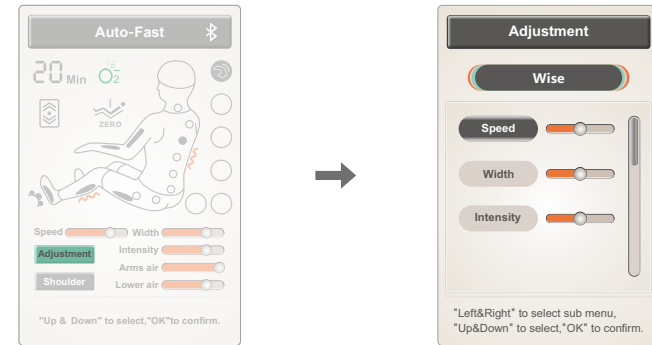

01).Adjustment function (adjustment button - massage techniques)

- Adjustment function (massage techniques): the massage technique adjustment function is for the adjustment of massage speed, width and intensity, etc.
- Press the "UP" or "DOWN" button to select the speed or width function. Then press "OK" to adjust the speed and width.

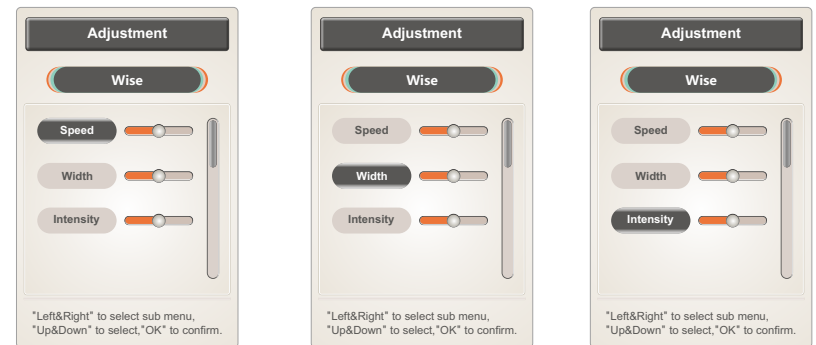

Note:

- Speed: The massage speed of manipulators is adjustable; there are 5 speed levels.
- Width: In the massage state of tapping and shiatsu, the width is adjustment, and there are five width levels in total.

Method of Usage

02).Adjustment function (adjustment button - massage area)

- Adjustment function (massage area): In the fixed point or local massage area state, such manipulator will move upward if you hold down the "UP" button; after you release it, such movement will stop. Such manipulator will move downward if you hold down the "DOWN" button; after you release it, such movement will stop.
- Press the "UP" or "DOWN" button to select the massage area for adjustment.

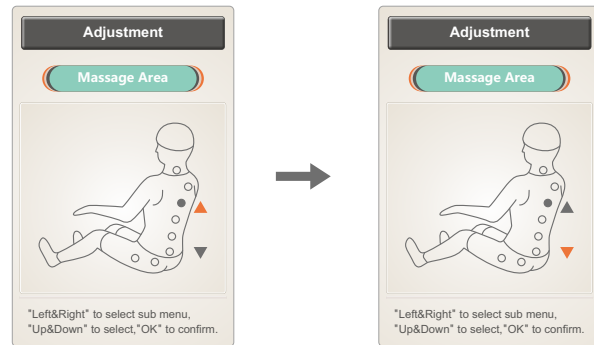

03).Adjustment function (adjustment button - massage intensity)

- Adjustment function (massage intensity): including such massage functions as airbag massage functions for the upper body and the lower body, and foot roller; there are 3 levels of intensity for switching.
- Press the "UP" or "DOWN" button to select the air pressure intensity or the roller massage intensity. Then press "OK" to confirm such intensity.

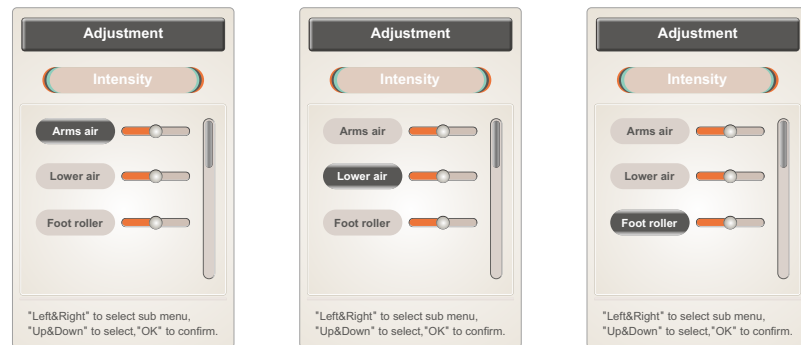

Method of Usage

04).Adjustment function (adjustment button - other adjustments)

- Adjustment function (other adjustments): only timing available now. When "OK" is pressed every time, the duration will increase by 5 minutes; if it exceeds 40min, 40min will be reduced.
- Press "OK" for time adjustment (when "OK" is pressed every time, the duration will increase by 5 minutes; the minimum duration is 5min, and the maximum duration is 40min)

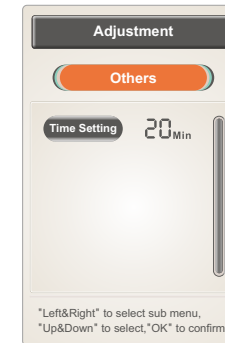

8.Customize

- Press the "Menu" button to select "Customize" in the main menu. Then enter the "Custom Storage" interface to select a specific interface, including: Custom Storage I, II, III, and other storage or call function.
- Press the "Left" or "Right" button to select the storage or call function. Then press "OK" to confirm your choice.
- Press the "UP" or "DOWN" key to select Custom Storage I, II or III.
- Storage: Store all the current massage techniques, air pressure, angle, and other massage functions.
- Call: Call the massage techniques, airbag massage, angle, and other massage functions previously stored.
- Press the "Back" button to return to the operating status information interface.

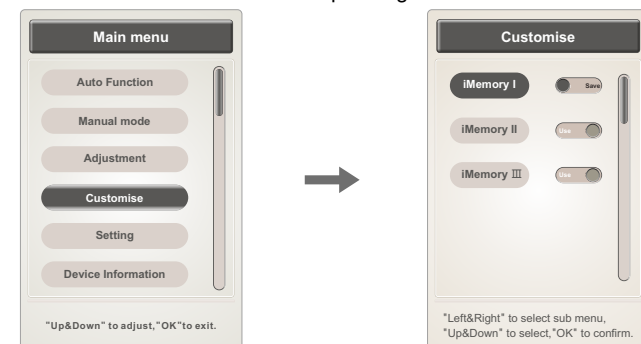

Method of Usage

9.Settings

- Press the "Menu" button to enter the main menu interface. Select the "Settings" function icon to enter the setting interface for language, backlight, auto-lock and other settings.
- Press the "Left" or "Right" button to switch among the submenus. Press the "UP" or "DOWN" button for function selection. Alternatively, press the "Back" button to return to the operating status information interface.

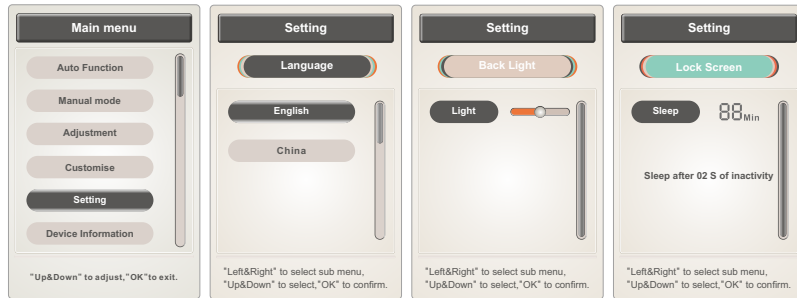

01).Settings (language)

- Settings (language): Select Chinese or English.
- Press the "UP/DOWN" button for language selection. Then press "OK" to confirm your choice.

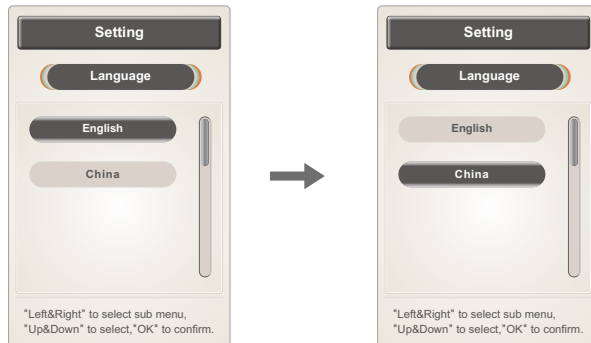

Method of Usage

02).Settings (auto-lock)

- Settings (auto-lock): including timing and no auto-lock; in case of no operation, the auto-lock will be activated after 2 sec.
- Press "OK" to adjust the auto-lock duration. When "OK" is pressed every time, the auto-lock duration will increase by 15 sec, 30 sec, 1min or 2min; or the auto-lock will never be activated if you have checked the "No Auto-Lock" option. Press "OK" for switching.

03).Settings (backlight)

- Set the (backlight) brightness. Press "OK" to adjust the brightness. There are 5 brightness levels for your option.
- Press the "Back" button to return to the operating status information interface.

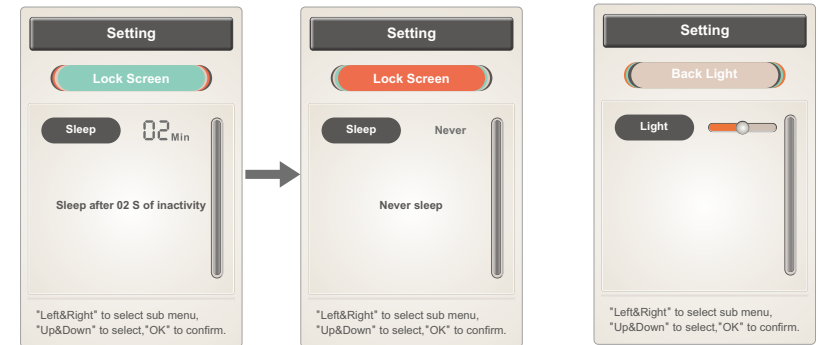

10.Equipment information

- Press the "Menu" button to enter the main menu interface and select the equipment information function. The information on the current equipment will be displayed.
- Press the "UP/DOWN" button for selection. Then press "OK" to confirm your choice. Alternatively, press the "Back" button to return to the operating status information interface.

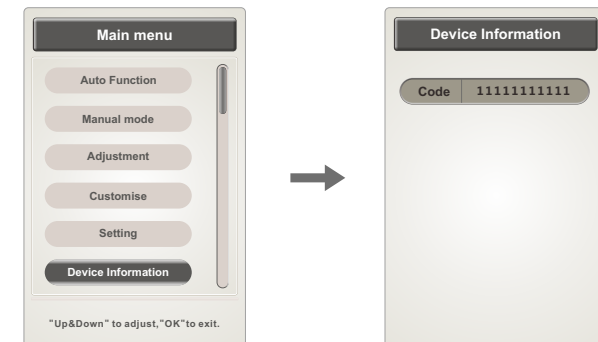

Method of Usage

11.Zero gravity key

· Press the "Zero Gravity" key to adjust the position for zero gravity. Upon your request, you can select the position for "Zero Gravity I" or "Zero Gravity II."

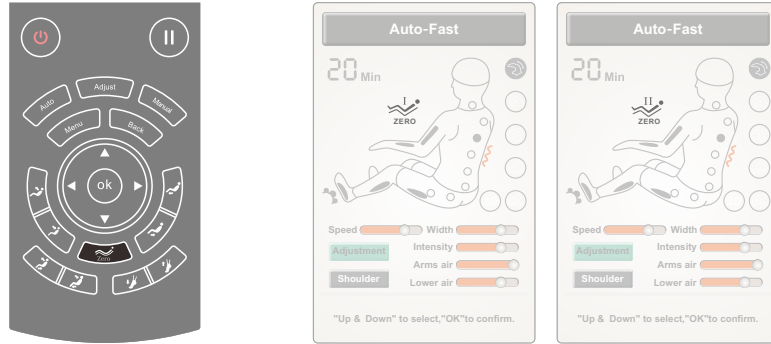

Button	Description
	Zero Gravity I: Adjust to the angle for Zero Gravity I.
	Zero Gravity II: Adjust to the angle for Zero Gravity II.

12.Back button

· During adjustment of any massage function, if you want to return to the operating status information interface, you can press the back button to return to the operating status information interface.

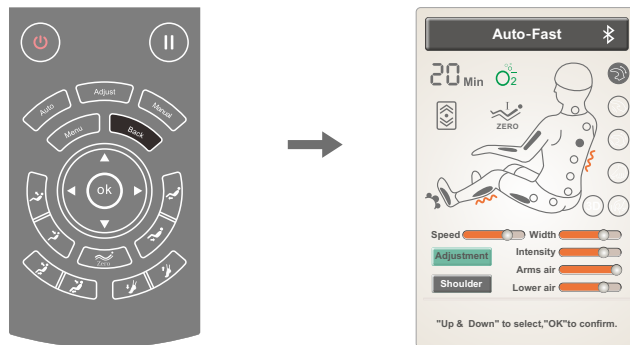

Method of Usage

13.Lying angle adjustment button

Button	Description
	Legrest UP key: Hold down this key, and the legrest will rise slowly; release it, and the legrest will stop rising. After the leg upward movement is completed, the legrest will automatically detect the length of the feet.
	Legrest DOWN key: Hold down this key, and the legrest will move downward slowly; release it, and the legrest will stop downward movement. After the leg downward movement is completed, the legrest will automatically detect the length of the feet.
	Backrest up button: Hold down the button to make the backrest rise slowly. Release it to stop such action.
	Backrest down button: Hold down the button to make the backrest move downward slowly. Release it to stop such action.
	Linkage sitting key: By holding down this key, the backrest will rise slowly and the legrest will move downward slowly; by releasing it, such UP/DOWN action of the backrest and the legrest will be stopped. After linkage sitting is completed, the legrest will automatically detect the length of the feet.
	Linkage lying key: By holding down this key, the backrest will move downward slowly and the legrest will rise slowly; by releasing it, such DOWN/UP action of the backrest and the legrest will be stopped. After linkage lying is completed, the legrest will automatically detect the length of the feet.
	Zero-gravity key: After this key is pressed, the positions of the legrest and the backrest can be automatically adjusted to the positions for zero gravity. There are two levels of zero-gravity lying modes, which can be switched.
	Footrest retraction button: Hold it down to manually adjust the footrest and retract it slowly; if it is released, such action will stop.
	Footrest extension button: Hold it down to manually adjust the legrest and extend it slowly; if it is released, such action will stop.





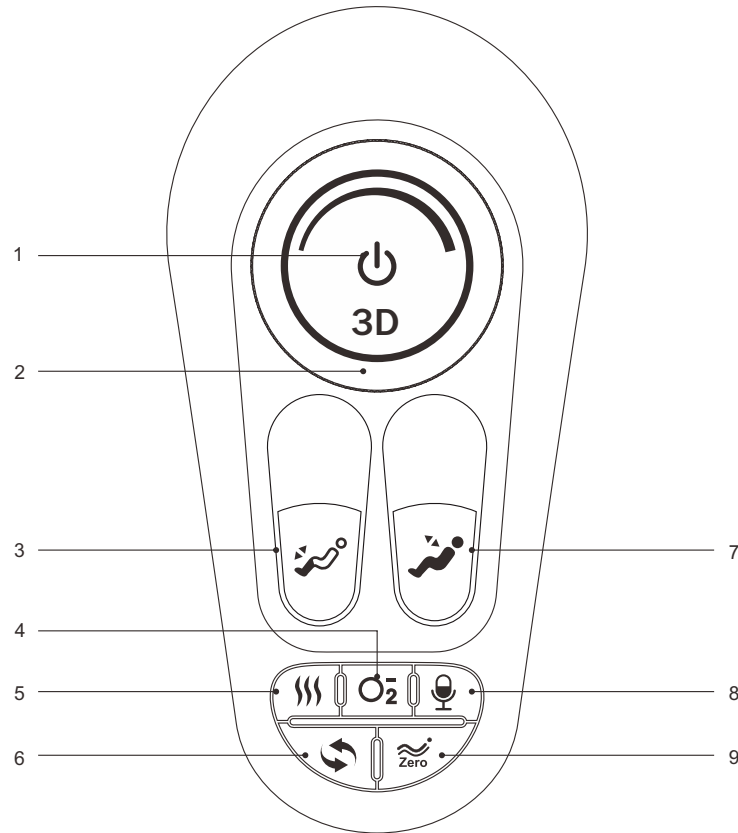





Method of Usage

III. Introduction to Armrest Shortcut Keys



1. Power button: turn on or off the massage chair.
2. 3D massage intensity button: adjust the 3D massage intensity.
3. Footrest extension/retraction: adjust the footrest extension/retraction function.
4. Anion key: click the key to enable or disable the anion function.
5. Heat treatment key: click the key to enable or disable the heat treatment function.
6. AUTO key: press it to enable the automatic massage function.
7. Linkage lying key: adjust the linkage lying angle.
8. Voice control and wake-up button: Short press to enable the voice control function, long press 3 seconds to turn on or off the voice control function.
9. Zero-gravity key: press it to adjust the massage chair to the angle for zero gravity.

Method of Usage

Button	Description
	Power button: Short press this button to pause the operation; if it is hold down for 3 seconds, power will be ON/OFF. If the pause time during massage exceeds 20 minutes, all the massage functions will be automatically turned off.
	3D massage intensity button: Rotate the button clockwise or counterclockwise to adjust the 3D massage intensity.
	Footrest retraction button: Pull it to let the footrest retract slowly; if it is released, such action will stop
	Footrest extension button: Press it to let the footrest extend slowly; if it is released, such action will stop.
	Linkage sitting key: By pulling this key, the backrest will rise slowly and the legrest will move downward slowly; by releasing it, such UP/DOWN action of the backrest and the legrest will be stopped. After linkage sitting is completed, the legrest will automatically detect the length of the fee.
	Linkage lying key: By pressing this key, the backrest will move downward slowly and the legrest will rise slowly; by releasing it, such DOWN/UP action of the backrest and the legrest will be stopped. After linkage lying is completed, the legrest will automatically detect the length of the feet.
	Heat treatment key: Click the key to enable or disable the heat treatment function.
	Anion key: Hold down the key to enable or disable the anion function.
	Voice control and wake-up button: Short press to enable the voice control function, long press 3 seconds to turn on or off the voice control function.
	Automatic mode key: Press it to switch among those automatic massage functions.
	Zero-gravity key: After this key is pressed, the positions of the legrest and the backrest can be automatically adjusted to the positions for zero gravity. There are two levels of zero-gravity lying modes, which can be switched.

Method of Usage

IV.Voice Control Instruction

- When the massage chair is turned on or in standby mode, the sound "Hi Alice" or "Hey Alice" will be produced to enable the voice control function. Alternatively, you can press the voice control button on the right armrest to enable the voice control function.
- Long press 3 seconds to turn on or off the voice control function.
- After such function is enabled successfully, the massage chair will reply "I am here." At this moment, once a corresponding voice control entry to be implemented is given within six seconds, the corresponding voice control function can be performed after a reply is received from the massage chair; if no correct voice control entry is given within six seconds, the voice control function automatically will be off automatically and needs to be enabled again.
- Note: When waking up the voice control function, please use English, the speech rate is moderate, Voice commands should be follow up the Voice entry.

Voice Control Entry		
Entry: "Hi Alice" or "Hey Alice". Answer: I am here.		
No.	Voice control entry	Answer entry
1	Massage on	Answer: Ok, massage on
2	Massage close	Answer: Ok, massage close
3	Comfort Massage	Answer: Ok, comfort massage
4	Relax massage	Answer: Ok, relax massage
5	Full body massage	Answer: Ok, full body massage
6	Neck and shoulder massage	Answer: Ok, neck and shoulder massage
7	Back and waist massage	Answer: Ok, back and waist massage
8	Stretch massage	Answer: Ok, stretch massage
9	Open the air pressure	Answer: Ok, open the air pressure
10	Close the air pressure	Answer: Ok, close the air pressure
11	Up the seat position	Answer: Ok, up the seat position
12	Down the seat position	Answer: Ok, down the seat position
13	Change the other mode	Answer: Ok, change the other mode
14	Go little down	Answer: Ok, go little down
15	Go little up	Answer: Ok, go little up

Note: commands 14 and 15 can only be used after command 13.

Method of Usage

V.Turn off the Power and Stop Massage

- If the power button is pressed during massage, all the massage functions will be turned off immediately, and the backrest and the footrest will go back to their default positions. If the massage time is up, all the massage functions will be turned off immediately, but the backrest and the footrest will not go back to their default positions.
- Shut off the power supply of this product as shown in the attached figure (Power Shut-off Diagram of the Product).

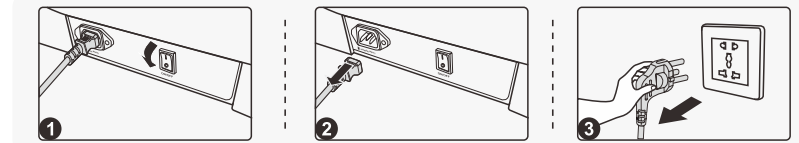

- 1 Power Shut-off Diagram of the Product
- 2 Disconnection Diagram
- 3 Unplugging Diagram

VI.Operation Instructions for Bluetooth Speaker Play

1. Enter the smart device main menu. Open "Settings" and select the "Bluetooth" option. Open "Bluetooth," and Bluetooth will automatically "Search for a New Bluetooth Device."
2. The smart device will search for the corresponding Bluetooth model (e.g. IMCM-XXXX). Click the "Match" button. If you are asked whether to match with the device, you just select "Match" to complete matching.
3. Turn on "Music Player" in the smart device and select the song to play.

VII.Installation Instructions for Armrests

1. Locate the connector plug and the air pipe from the bottom of the frame, and pass them out from the center of the frame (Figure 1).
2. Unpack the armrest. The connector plug and the air pipe on the armrest should correspond to those on the bottom of the frame (connection based on the marks for connection on the actual items) (Figure 2).

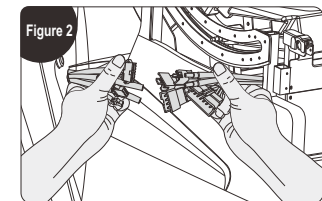
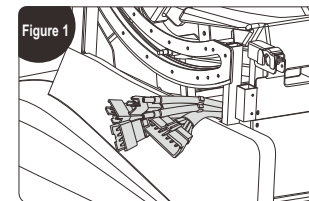

Method of Usage

3. Connect the connector plug and the air pipe on the armrest with those on the bottom of the frame correctly and firmly (Figure 3).
4. After such connection, insert them on the bottom of the frame and pay attention to avoiding any air pipe bending during insertion (Figure 4).

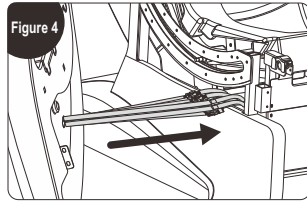
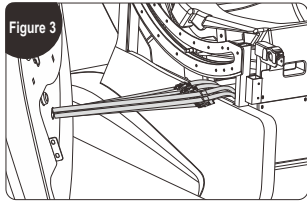

5. Hold the armrest with both hands. Firstly, hook the front end of the armrest into the steel frame and press down the front end of the armrest. (Figure 5).
6. Next, connect the lamp wire on the rear end of the armrest with the connector on the capsule, and insert it into the capsule. Then align the male buckle on the rear end of the armrest with the female buckle on the capsule. Insert the rear end of the armrest into the female buckle on the capsule. Tighten the connection firmly (Note: The clearance between the armrest and the capsule should be even) (Figure 6).

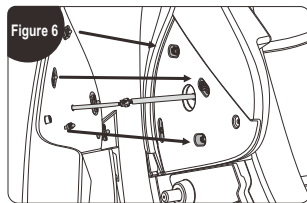
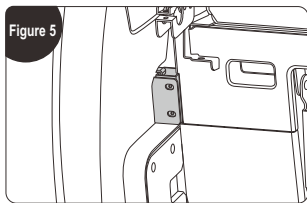

7. Fasten the rear end of the armrest with a M6*20 screw (Figure 7).
8. Next, pull the upper arm leather cover and fix with a M5*16 screw (Figure 8).

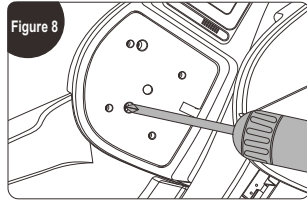
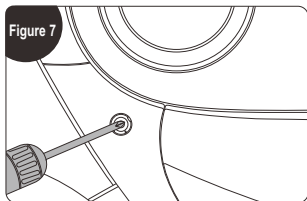

Method of Usage

9. Align the mounting holes on the steel frame on the front end of the fixed armrest and fasten the armrest to the steel member of the frame with two M5*16 screws (Figure 9).
10. Attach the screw hole plug on the rear end of the armrest (Figure 10).

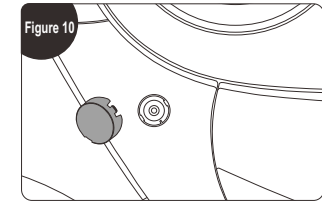
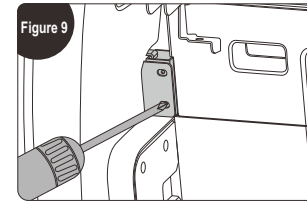

VIII. Installation Instructions for Legrest

1. First of all, cut the connection wire and the air pipe tie fixed on the steel pipe (Figure 1).
2. Connect the connection wire and the air pipe leading from the lower end of the backrest to the legrest connectors. Confirm whether butt connection is OK. Then insert the butt connection wire and air pipe into the bottom of the frame from the lower hole of the backrest. Pay attention to avoiding any air pipe bending during insertion (Figure 2).

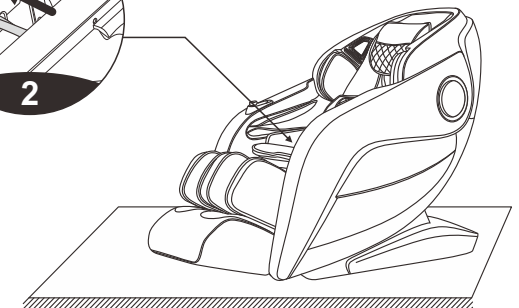
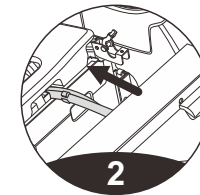
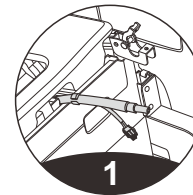

Method of Usage

3. Firstly, insert the rotating inner sleeve and the rotating outer sleeve into the left and right rotation shafts of the legrest (Note: The large step must face inward) (Figure 3).
4. Then remove the rotation shaft cover supporting the legrest on the left and right frames of the massage chair (Figure 4).

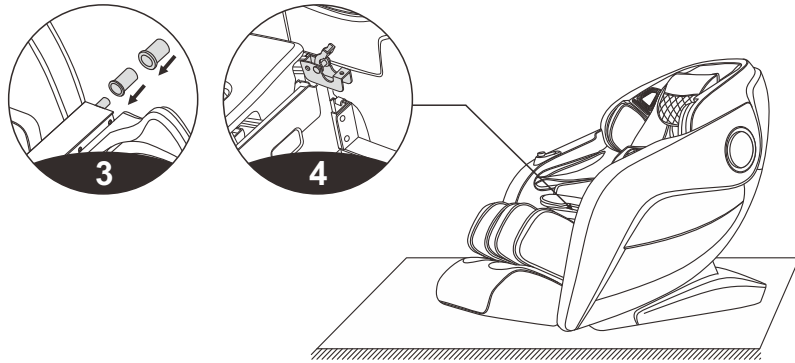

5. Next, hang the legrest (left and right rotation shafts) into the rotation shaft cover supporting such frames simultaneously (Figure 5).
6. Place the rotation shaft cover. Press the rotating outer sleeve of the legrest. Then tighten the rotation shaft cover supporting the legrest with two M5×14 black zinc environmentally-friendly hexagonal socket head screws and a 6×12×1.5 black zinc environmentally-friendly flat pad by the supplied 4# hex wrench (Figure 6).

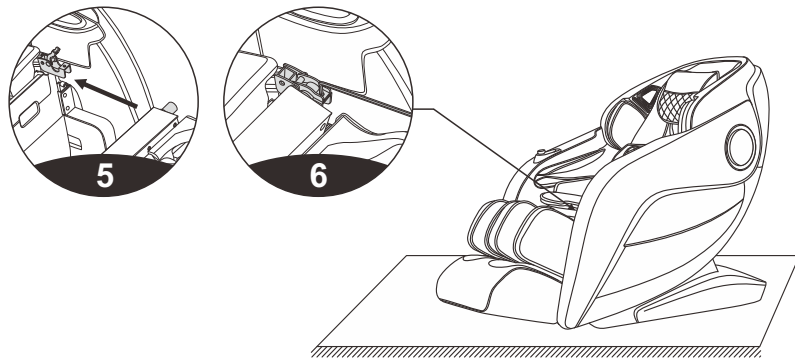

Method of Usage

7. After the screws are tightened, hook the groove at the back end of the legrest cover to the hinge pin. Then press down the front end of the legrest cover to make it completely parallel to the rotation shaft cover. Hook the convex point at the side of the legrest cover to the hole at the side of the legrest hook. Finally, the legrest is installed (Figure 7)

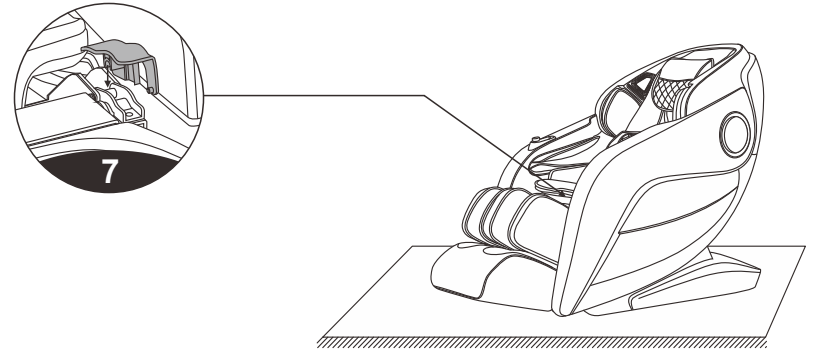

IX. Instructions for Removal and Use of Head Cushion and Backrest

- The use of the head cushion can reduce the intensity of kneading massage on the neck and shoulders. You can decide whether to use the head cushion according to your own needs (the head cushion is recommended). The backrest and the back cushion are connected by a zipper (1). The head cushion and the backrest are connected by a hook-and-loop fastener (2).

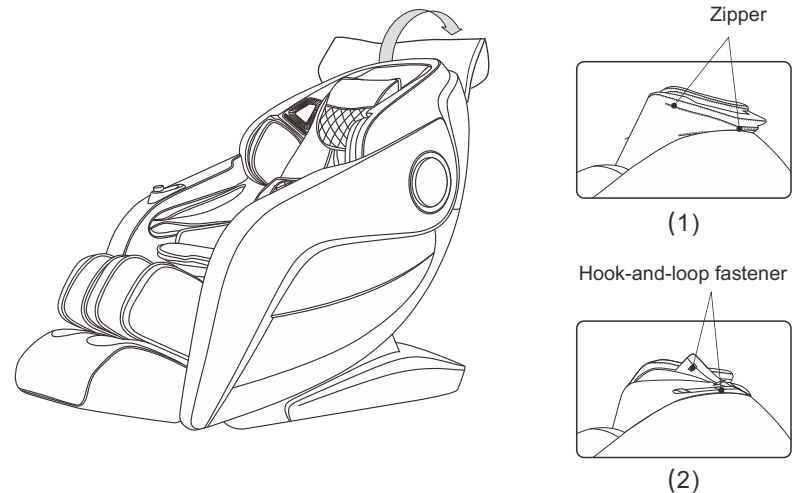

Method of Usage

X.Floor Protection

- The prolonged heavy pressure on the massage chair may cause scratches on the floor. Thus, put a carpet or cushion on the floor where the massage chair is placed to avoid this damage.

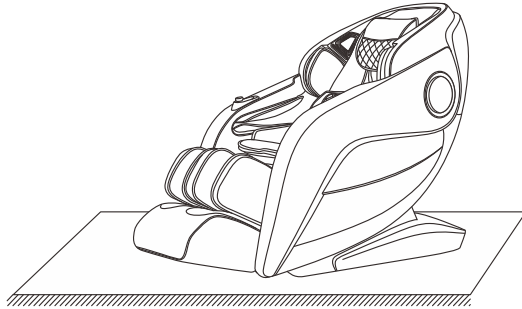

Note: Do not move the massage chair with its wheels on the rough ground or in a narrow space. At least two persons are required to lift it. During lifting, take the legrest sealing plate and backrest cover grooves as the acting points. (Do not lift the armrest directly.)

XI.Instruction for Movement

- When moving the massage chair, make sure that all the wires are pulled out of the massage chair surface; two persons must work together to move the massage chair. There should be one person respectively in front of and behind the massage chair. The person in front of the massage chair should lift it, while the person behind it should push it downward. When the center of gravity of the massage chair is completely on the base wheels, you can push the massage chair forward to a suitable position and then gently restore it to the normal angle. (Note: During movement, you must turn off the power switch first and then unplug the power cord and the remote controller connection wire.)

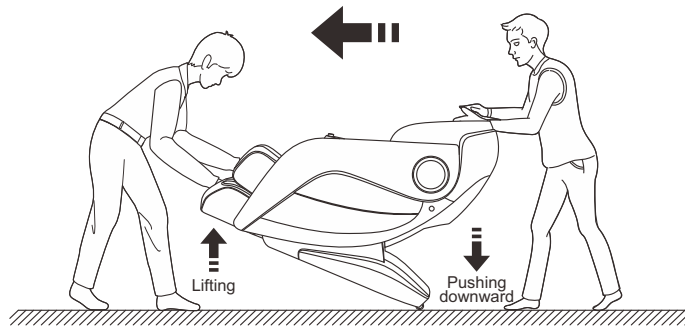

Warning : The rear moving wheels of the massage chair are only suitable for short-distance and slow movement. For long-distance transportation, please use other auxiliary moving tools to move this massage chair!

Product Specification

Model: Opulence

Name: Massage Chair

Rated voltage: 110-120V~ 60Hz

220-240V~ 50Hz/60Hz

Rated power:220W

Rated time: 20min

Safety structure: Class I

Material description: PVC, PA, steel parts, electric and electron components

MATERIAL	PU	LEATHER	CLOTH	WOOD