

# 360 Robot Vacuum Cleaner User Manual

## Dear customers:

Thank you for choosing the intelligent 360 Robot vacuum cleaner! Please read all instructions before using your robot. Please retain the operating instructions for future reference. Enjoy your robot! This product is a high-intelligence planning sweeping robot based on high-precision lidar combined with various sensors, working together through navigation algorithms to realize real-time indoor positioning and mapping. Sweep, suck, drag. Regular, efficient and full-coverage indoor cleaning need no manual intervention.

## 360 Robot Vacuum Cleaner Contact List

Region	Global
Website	<a href="http://www.360smartai.com">www.360smartai.com</a> <a href="http://Smart.360.cn/Cleanrobot/en">Smart.360.cn/Cleanrobot/en</a>
Facebook Account	@360SmartAI
Tel./E-mail	<a href="mailto:support@360smartai.com">support@360smartai.com</a>
After-service Add.	—

※ This data is for the actual product. Our company reserves the right to update it anytime. All product specifications are subject to change without notice.

## Product Overview

---

### Main unit

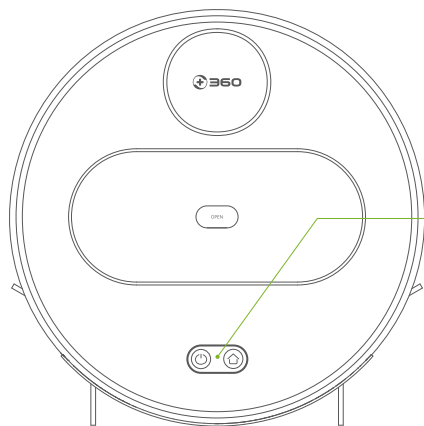

#### Recharge / regional cleaning

- Short press to recharge/pause
- Long press and hold to start regional cleaning

#### Ring indicator light

- Blue light: normal working or charging
- Red light: abnormal or low battery
- Purple light: The device is ready to connect Wi-Fi

#### Cleaning/power on or off machine

- Short press to start sweeping/pause
- Press and hold for 3 seconds to turn on/off
- If abnormal condition, please press and hold for 15 seconds to force poweroff

#### Note:

- Press any key while cleaning, recharging or regional cleaning to pause the current task.
- Press both buttons and hold for 3 seconds to reset Wi-Fi.
- Please knob down cleaning/power and recharging/partial cleaning button over 10 seconds to become lower power dissipation status When cleaner is on the charging base. And one more time for closing this status.

## Main unit

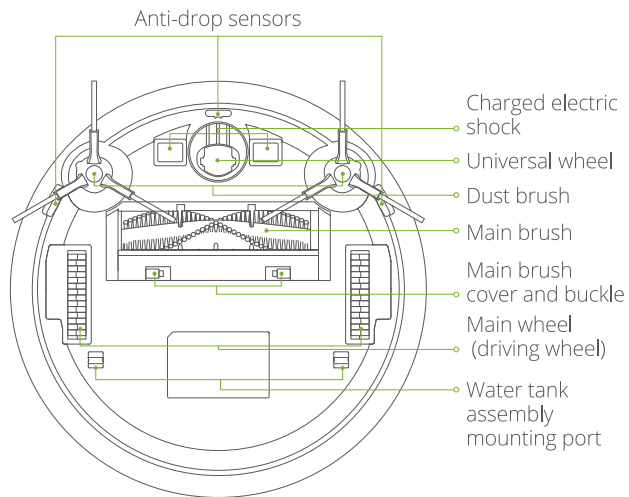
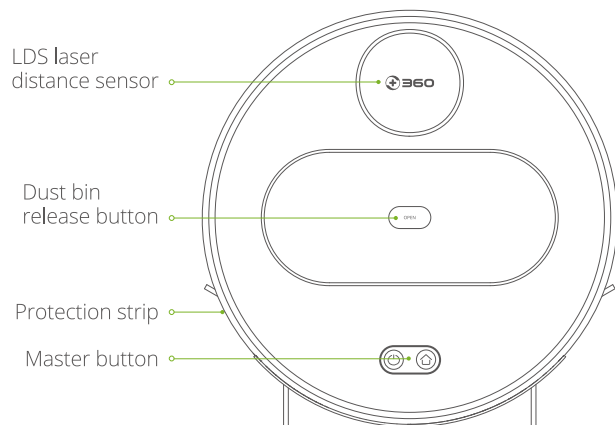

## Main unit

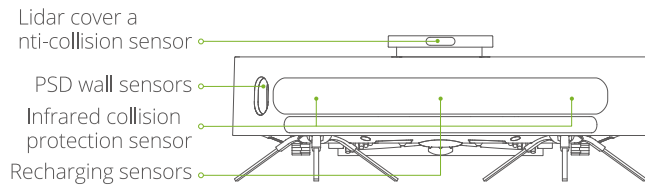

## Water tank

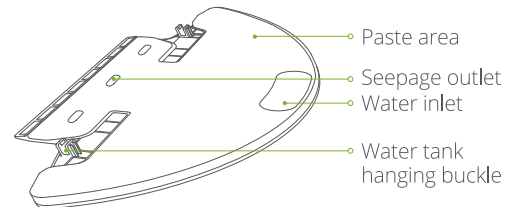

## Dust bin

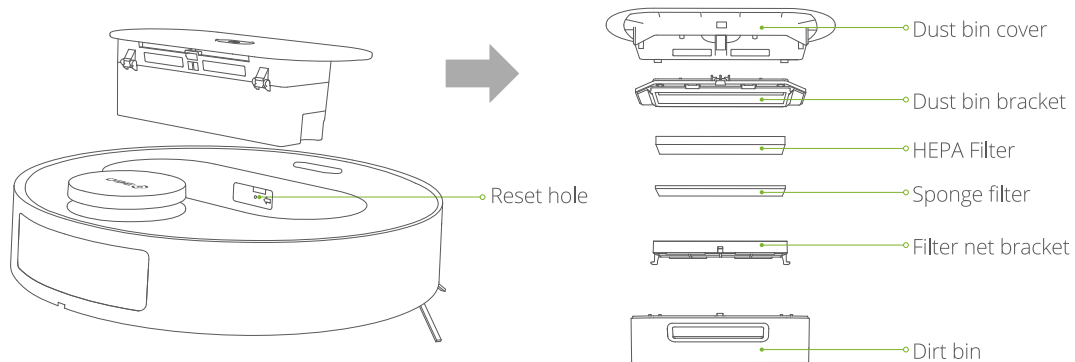

## Charging dock

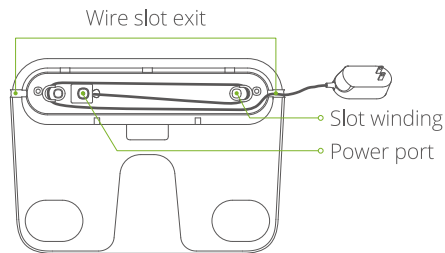
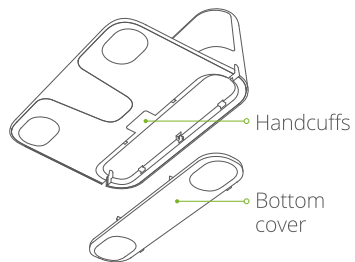
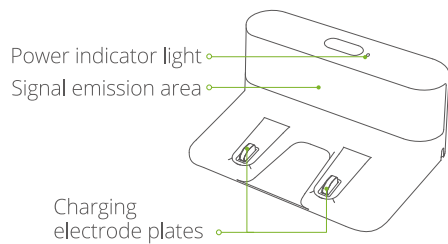

## Packing List

---

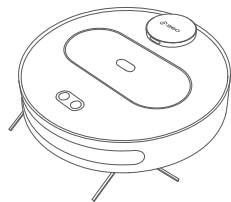

Main unit X 1

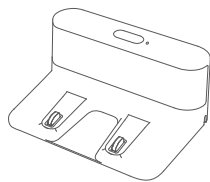

Charging dock X 1

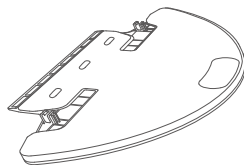

Water tank X 1

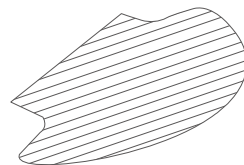

Mop X 1



User manual X 1

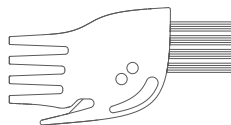

Cleaning tools X 1



Power Adapter X 1



## Installation Instructions

1) Connect the power cord, put extra wire in the slot.

Note:

- The extra power cord touched the ground can be pulled by the main unit to cause the interruption of charging.
- The charging dock indicator is always on and goes off when charging.

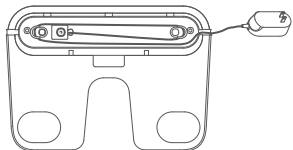

3) For the convenience of the robot vacuum cleaning and recharging properly, please do not frequently move the charging dock. If the location of the charging dock is changed, the robot vacuum may lose the map due to failure in positioning. When it works again, the robot vacuum will re-create and memorize the map.

Note:

- e-creation may result in the loss of information of restricted zone and regional cleaning.
- Avoid direct sunlight

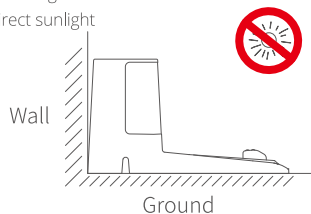

2) Place the charging dock on a level ground and connect the power supply.

Note: Please make sure that there are more than 0.5 meter space on both sides of the charging dock and more than 1.5 meters space in front of the charging dock.

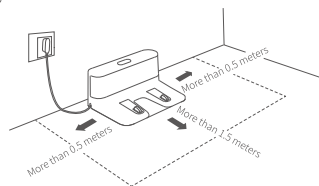

4) Before use, be sure to remove the protective strip on the bumper to ensure proper operation of the device.

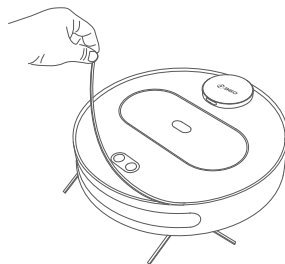

## 5) Power on and Charging

**Method 1:** Press and hold the Power (⏻) key to power on, wait for the ring indicator to light up and place the main unit within one meter of the charging dock. By tapping the Home (🏠) button, the device will automatically search for the charging dock and go to charging.

**Method 2:** Place the robot vacuum on the charging dock and align it with the charging electrode plates. The power indicator on the charging dock changes from bright to dark. The device automatically power on and starts charging by default. After the device is turned on, it can be used normally.

Note: If the battery is low, the machine will not turn on. Please place the main unit on the charging dock and the device will start automatically. The power of the device should be  $\geq 30\%$  before it can work.

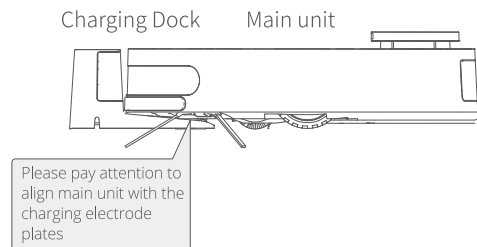

Note: Before charging, wipe the robot vacuum charging pad with a dry rag, and put aside the side brush at the same time to prevent the poor contact coming from side brush or dust.

## 6) Download the mobile phone APP

**Method 1:** Scan the QR code below by using mobile phone to download the APP.



**Method 2:** Search for "360Smart" in Google Play or Apple Store, then find its APP and download it. Follow the APP to configure the network of the device.

Note: When the mobile phone is not connected to the cleaning robot, please refer to the "User's Manual" - "Reset Wi-Fi" to operate.

Wi-Fi indicator status:



**Slow blinking PURPLE light: waiting for connection**

**BLUE light: Wi-Fi is connected**

# Operating Instructions

## Clean/pause

**Method 1:** After the power is turned on, short press the Power (⏻) key on the main unit to start cleaning (press any key to pause while cleaning).

**Method 2:** Click the clean key in the APP to start cleaning (press the pause key to pause the current task).

Note:

- Robot vacuum cleaner cannot be used to clean liquids.
- When battery is lower than 20%, the Robot will automatically return to the charging dock. After the battery reaches 80%, the Robot will stop the charging itself and start the cleaning again.
- Please remove all types of wire (including the power cord of the charging dock) on the floor before cleaning because dragging from the worked robot vacm can cause a power failure and damage items or wire.

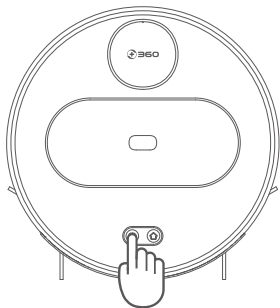

Method 1



Method 1

## Cleaning method

After startup, the robot will scan to generate maps and intelligently create areas. In these areas, the cleaning paths are planned as along the wall firstly, followed by the bow-shaped filling method. The cleaning in each area will be accomplished step by step with high efficiency and full coverage. After the cleaning is completed, Robot will automatically return to charging dock to recharge itself.

Note: Please don't move Robot frequently. Please place the device near the original place if you move it manually. Robot will try to reposition its coordinates when it is started again. If the positioning is successful, Robot will continue to work according to the planned clean path. If the positioning fails, Robot will give up the current task and re-create the map and may not be able to complete the recharge.



## Loss of regional information

**Case 1:** Starting the Robot in a new area to clean can cause the Robot to re-create map.

**Case 2:** The main changes of the environment may result in the failure of reposition and may trigger to re-create the map. Regenerating map will lose all the settings of the original one (including the restricted zone).

## Recharge

Automatic mode: After cleaning is completed, the device will automatically return to the charging dock to recharge itself.

Manual mode: Under paused state, short press the Home  key to start the recharge, or the APP triggers the recharge.

Note: The ring indicator light flashes while Robot is charging.

## Customized area

### 1) Customized area cleaning

Users can define one or more of the size and location of the cleaning area. Under such a condition, Robot will only clean the set area and will NOT clean the unset area. Meanwhile, the number of cleanings can be set. The default cleaning is 2 times and 1 time cleaning can also be set optionally.

### 2) Set up restricted zone

It is also possible to set certain area as a restricted area where Robot will not enter. The restricted area can also be set as a permanent forbidden zone which applies to a room or area that you do not want Robot enter it. (See the diagram below).

Note:

- Robot may intrude into the restricted area due to incorrect positioning, sensor abnormality and some other reasons.
- The permanent forbidden zone may become invalid due to a big change in the location of the charger or furniture. Therefore, please try not to move or interfere with Robot during cleaning.
- Re-creation of map will lose the settings of the previous forbidden zone.



## Spot cleaning mode

It is particularly applicable for an area which needs deep cleaning. When a user specifies a point on the map, Robot will be near the point and a 2m\*2m sweep will be performed around this point. It is easy to drag or click to set the target point in your map operation. The number of cleaning points can be set. The default cleaning is 2 times for each point and 1 time cleaning can also be set optionally.

## Regional cleaning mode

When Robot is off-line or when the mobile phone is not in the vicinity, you can press and hold the recharge button for 3 seconds, then Robot is centered on itself and is cleaned by 2m\*2m. At this time, the user can manually move Robot to the designated location for regional cleaning.



## Scheduled cleaning

Use phone App to schedule a cleaning time, Robot will automatically start cleaning at the scheduled time, and automatically return to the charging dock after the cleaning is completed.

## Reset Wi-Fi

When the router changes settings, passwords, or other reasons that prevent the phone from connecting to Robot, press and hold the Power (⏻) key and the Home (🏠) key simultaneously for 3 seconds till the voice prompts "Wi-Fi has been reset" and the Wi-Fi indicator changes to slow flashing purple light which indicates that the reset was successful.

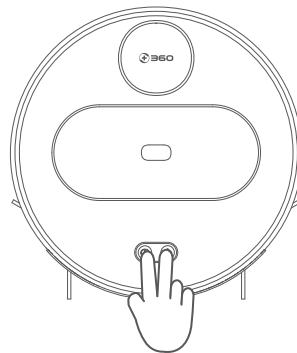

## Do-not-disturb mode

During the Do-Not-Disturb period, Robot will not automatically power off and play voice. The Do-Not-Disturb mode is enabled by default after the main unit has been deployed with internet for the first time. The open period is from 22:00 to 08:00. You can use the phone App to turn off the Do not disturb mode or modify the Do-Not-Disturb mode time period.

## Cleaning mode

Quiet, automatic and powerful modes can be chosen by the phone App. The default is automatic mode.



## Usage of water tank components

**Note:** In order to obtain a better result of mopping, it is recommended to use the water tank to mop the floor after the robot cleaner completes at least three times cleaning.



Step 1: Add water

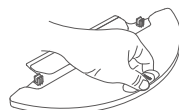

Step 2: Tighten the water tank buckle

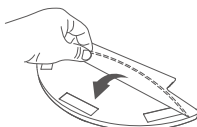

Step 3: Put on mopping cloth

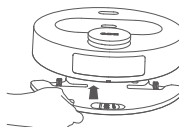

Step 4: Pull the water tank into the main unit

- The Robot's mopping function only has a wiping effect, which helps deep cleanliness but cannot effectively remove stubborn stains (such as dried coffee stains, etc.). At this point, robot vacuum cannot completely replace humans.
- Please be caution when you choose the mopping mode using in your carpet area. To avoid to stain the carpet, please do not use the mopping mode. You can prevent robot vacuum from entering the carpet area with water tank by setting the restricted area on the APP.
- Please pause the device in place when water need to be added or rags need to be cleaned when Robot is working. Lift the device at a small angle, remove the water tank and put it back after adding water or cleaning rags. And then, return the main unit to its place and restart it, Robot will try to follow the planned path to continue cleaning.
- For safety reason, make sure to remove the water tank components from the unit when charging.
- **DO NOT USE MOPPING MODE** when nobody is at home.

## Routine Maintenance

---

### Water tank

To maintain the efficiency of cleaning, please clean the water tank and rags right after each use.

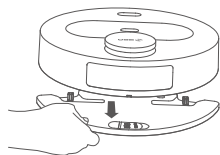

step1  
After mopping, lift the device at a small angle,  
remove the water tank

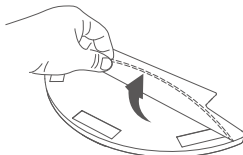

step2  
Remove the rag



step3  
Clean the rag



step4  
Drain the water tank completely

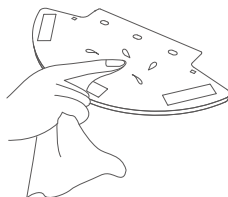

step5  
Wipe the water tank

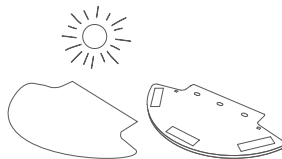

step6  
Dry the rag and water tank for next use

## Dust bin and Filter

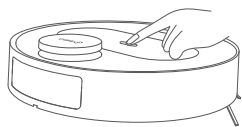

step1

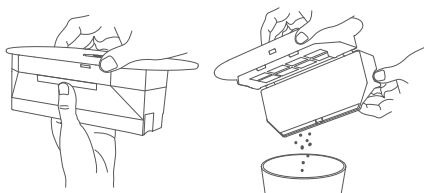

step2

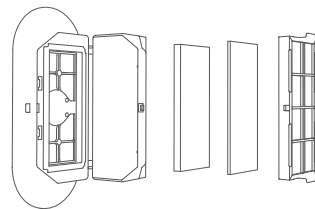

step3



step4

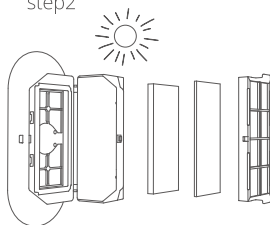

step5

Step1: Press the "OPEN" button to remove the dust bin.

Step2: Open the dust bin buckle and empty the dust bin. To avoid spilling the dust, keep the top cover of the dust bin facing up, hold the top cover with your right hand and the transparent dust bin with your left hand. To avoid clogging of the filter, tap the dust bin when you empty it (it is recommended to clean it at least once a week).

Step3: After a longer period of use, remove the filters component: the filter net, the sponge filter, the high-efficiency HEPA washable filter (recommended to replace a set of filters every 6-12 months to ensure good cleaning results).

Step4: Rinse dust bin and other three-layer filters (not too frequent, recommended monthly cleaning).

Step5: After rinsing, dry the water droplets. Be sure to dry Dust bin and filters completely before reinstalling them to ensure the lifetime of the device.

**Note:**

- Please rinse with clear water without any detergent. Please do not clean the filter with brush or fingers.
- Do not put an incomplete dust bin into the device which can avoid the air flow channel (wind channel) to be blocked or damaged when cleaning.



## Main brush (recommended weekly cleaning)

- 1) Turn the robot vacuum over, open the main brush cover by pressing the buckle on it, and then remove the main brush.
- 2) Use a blade attached to the dusting brush to cut off the entangled hair around the main brush.
- 3) The main brush bearings on both sides of the main brush can be removed to facilitate removal of the entangled hair in the gaps at both ends.

Note: It is recommended to replace the main brush every 6-12 months to ensure good cleaning results.

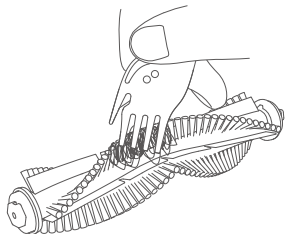

The main brush bearing

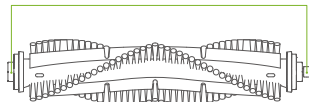

## Side brush (recommended monthly cleaning)

- 1) Turn the robot vacuum over, remove the screw of side brush, remove and clean the internal entangled hair and dirt, then reinstall it.
- 2) The entangled hair on the side brush can also be removed by using the blade attached to the dusting brush.

Note: It is recommended to replace the side brush every 3-6 months to ensure good cleaning results.

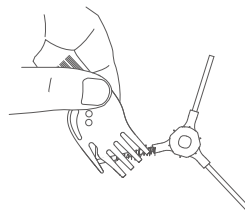
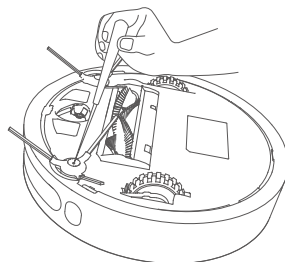

## Sensor

Wipe Robot sensors with a soft, dry cloth, including:

- 1) Wall sensor on the right side of Robot
- 2) three anti-drop sensors on the bottom of Robot
- 3) Infrared anti-collision sensor in front of Robot
- 4) Radar cover anti-collision sensor on the top of Robot
- 5) Lidar

The Lidar is a Light Detection and Ranging equipment. The sensor part contains a laser for emitting infrared (780nm), and a sensor for detecting light. The Lidar motor works for rotating the sensor part. The sample rate of the sensor is 2300 points per second.

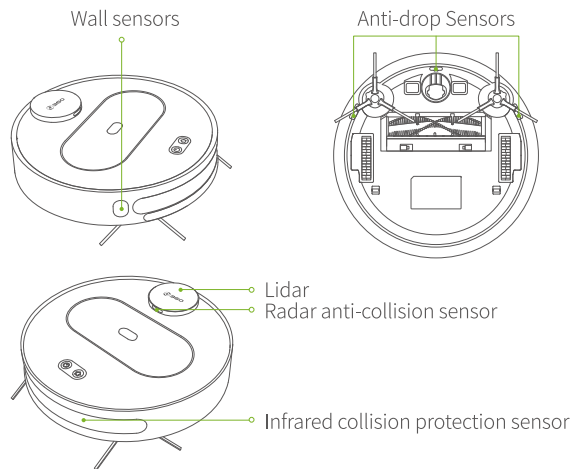

## Universal wheel (recommended monthly cleaning)

Turn robot vacuum upwards, pull out the universal wheel, clean up the wheel body, hair and dirt on the axle, and then reinstall and compress it.

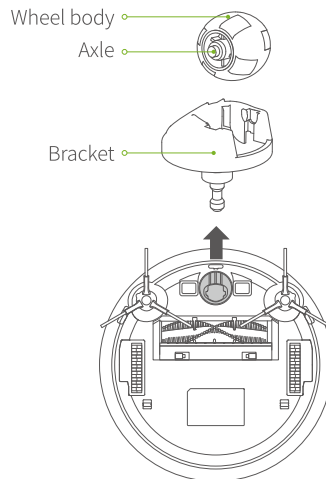

## Charging electrode plates

The part, as shown in the diagram, is the charging electrode plates. Please clean the charging electrode plates of Robot and the charging dock with a dry rag (Please turn off the electricity when cleaning. It is recommended to clean it monthly).

Charging electrode plates

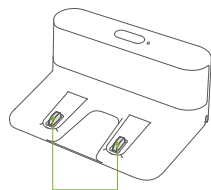
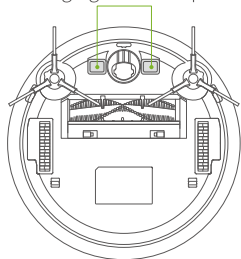

Charging electrode plates

## Battery

- Robot has a built-in high-performance rechargeable lithium battery pack. To maintain battery performance, please always keep Robot charged for daily use.
- If the Robot will not be used for a long time, please power off and store it. The Robot should be fully charged at least once every three months to avoid the battery damage due to over draining.

## Firmware Upgrade

The firmware can be upgraded through the phone App. After detecting the new firmware, follow the prompts to carry out the upgrade. When the firmware is upgraded, the power needs to be at least 50%. It is recommended to place Robot on the recharging dock for firmware upgrade.

## Reset

Remove the dust bin and open the rubber cover located on the side away from the radar. There is a small hole on the side near the USB port, poke it to reset. After the reset, the current map is lost and timed + Wi-Fi + Personalized settings will be reserved.

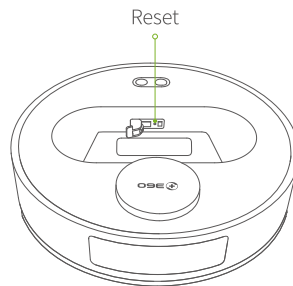

## Specifications

---

Main unit	
Name	Parameters
Dimensions	350*350*100mm
Product weight	3.5kg
Battery capacity	Minimum: 3000mAh, 44.40Wh Standard: 3200mAh, 47.36Wh
Rated voltage	14.8V
Rated power	30W

Charging dock	
Name	Parameters
Dimensions	200*138*86mm
Rated power	24W
Rated output	24W

## Frequently Asked Questions (FAQ)

Problem types	Causes and solutions
Unable to power on	<ol style="list-style-type: none"> <li>1) When the battery is running low, please place Robot on the charging dock and align it with the charging electrode plates and Robot will power on automatically (when it's completely out of power, Robot needs to be charged for a while before it powers on automatically)</li> <li>2) Ambient temperature is too low or too high (below 0°C/32°F or above 50°C/120°F), please use this product in temperature ranging from 0°C/32°F to 40°C/104°F.</li> </ol>
Unable to charge	<ol style="list-style-type: none"> <li>1) Please remove robot vacuum and check whether the charging dock indicator light is on. Make sure both of the charging dock and power adapter are all plugged in.</li> <li>2) Poor contact, please clean up the electric shock on the charging dock and the charging electrode shock on the Robot.</li> </ol>
Unable to go back to charge	<ol style="list-style-type: none"> <li>1) There are too many obstacles near the charging dock, please place the charging dock in an open area.</li> <li>2) Robot is too far away from the charging dock. Please try to place Robot near the charging dock.</li> </ol>
Abnormal behavior	Hold power key for seconds to shutdown and push to restart
Abnormal noise during cleaning	The main brush, side brush or wheel may be entangled by something, please shutdown and clean it.
The cleaning ability declines or dusting	<ol style="list-style-type: none"> <li>1) The dust bin is full, please empty and clean it.</li> <li>2) The filter is clogged, please clean or replace it.</li> <li>3) The main brush is entangled by something, please clean it.</li> </ol>
Cannot be connected to Wi-Fi	<ol style="list-style-type: none"> <li>1) When Wi-Fi signal is poor, please make sure the Robot is within the good Wi-Fi coverage.</li> <li>2) Wi-Fi connection is abnormal, please reset Wi-Fi and download the latest phone App to try to connect them again.</li> <li>3) Incorrect password input.</li> <li>4) The router is a 5G band. However, this robot only supports 2.4G band.</li> </ol>
Scheduled Cleaning mode is invalid	Insufficient power! The scheduled time cleaning can only be started when the remaining battery capacity $\geq 30\%$ .
Does the robot vacuum consume power when it is on the charging dock?	The power consumption is very low while Robot is charging, which helps to keep the battery at its best performance.
Does robot vacuum need to charge for 16 hours for the first three times uses?	Because of no memory, Lithium battery can be used after fully charged without waiting.

# Important Usage Notice

---

## Usage restrictions

- For indoor use only. Do not use this Robot outdoor (such as open balcony), non-ground (such as sofa), commercial or industrial environments.
- Do not use Robot in a drop-off environment (eg duplex stairs, open balcony, furniture top) without physical barrier.
- **Do not use Robot when the ambient temperature is higher than 40°C or lower than 0°C or if there is any liquid or viscous materials on the floor.**
  - Please hang up the ground cable in your home before use to avoid dragging the cable while Robot is running.
  - Please put away the fragile items and debris on the ground to prevent Robot from being blocked or a minor collision during running which can cause damage to the valuables in the home.
  - Do not allow the person (including children) with physical, mental or cognitive disabilities to use or operate this product.
  - Do not allow children to use the Robot as a toy. Please supervise children and pets as far as possible when Robot is working.
  - Please do not place the main brush cleaning tools in the areas where children can reach.
  - Please do not sit any objects (including children, pets) on the Robot.
  - Please keep people or pet hair, fingers, etc. away from the suction intake when Robot is working.
  - Please do not use Robot to clean the burning objects (such as burning cigarette butts).
  - Please do not use Robot to clean the long-pile carpets (some dark color carpet may not be cleaned properly).
  - Please do not allow Robot to pick up hard or sharp objects (such as decoration waste, glass, nails, etc.)
  - Please do not handle Robot by using the laser range sensor cover, main body cover, or mounting buffer as a handle.
  - Please clean or maintain the Robot and charging dock when they are powered off.
  - Do not wipe the product anywhere with a damp cloth or any liquid.
  - Please use this product following the instructions. Any loss or injury caused by improper use shall be the responsibility of the user.
  - Please do not use mopping function on the carpet or the top of the furniture.
  - Be sure to remove the water tank when charging.

## Battery and charge

- Please do not use any third-party battery, charger, or charging stand.
- Please do not disassemble, repair, or modify the battery or charging dock.
- Please do not place the charging dock near to any heating source(such as the heater)
- Please do not wipe the charger pad with a damp cloth or wet hands.
- Please do not throw away the waste batteries. They should be handled by a professional recycling agency.
- If the power cord is damaged or broken, stop using it immediately and purchase or replace it through 360 official service.
- If the product needs to be transported, please make sure the Robot is turned off. It is recommended to pack the Robot in its original packing box.
- If the Robot will not be used for a long time, please fully charge it. Turn off the main dock and store in a dry/cool place. Charge the Robot at least every 3 month to avoid over drain.

## Laser safety information

- This laser sensor meets the class 1 laser product standard of IEC60825 and does not produce dangerous laser radiation.
- Execution standard: IEC60335

### Product performance failure table

Name	Performance failure
Main unit	Failure of listed functions in instruction Cannot power on Main Brush, side Brush, fan or Driving wheel are not working.
Power adapter	Unable to provide power to the Charging Dock.
Charging dock	Unable to provide power to Robot.

## Troubleshooting

Failure prompt voice	Problems and Solutions
Error 0: Dust bin is disappeared!	Sweeping when dust bin is removed
Error 1: The Top radar seems to be blocked.	The top radar is covered or placed in an open area (without any obstructions in the area of 6*6 square meters)
Error 2: Need to change location to start.	Pick up the Robot; or the Robot is vacant
Error 3: Please wipe the bottom Anti-Drop Sensors.	Anti-drop sensor is blocked or placed on the high
Error 4: Please wipe the front anti-Collision Sensors	Wall detected sensor is dirty or blocked
Error 5: Please wipe the right side wall sensors.	Wall sensor is dirty or blocked
Error 6: Please clean the top radar cover.	The radar cover anti-collision sensor is dirty or blocked
Error 7: Oh, the edges seems to be stuck!	Edges or Anti-Collision Sensors is stuck.
Error 8: Please clean the dust bin and sponge filter, install them in the correct position.	Dust Bin is full or the filter needs to be replaced.
Error 9: Please clean the dust bin and the filter net	After prompting error 8, the user removes the dust bin and triggers an error 9 prompt
Error 10: Stuck! Please help!	Robot is stuck!
Error 11: I was paralyzed, please put me up!	Robot slant!
Error 12: Oh, Driving Wheel seems to be stuck, help!	Main wheel (driving wheel) is stuck or entangled with something.
Error 13: Oh, Main brush seems to be stuck, Help!	Main Brush is stuck or entangled with something.
Error 14: Oh, Side Brush seems to be stuck, Help!	Side Brush is stuck or entangled with something.
Error 15: Where is the Charging Dock?	Did not find the charging dock for recharging or the charging dock was not plugged in.
Error 16: Malfunction! Please try to restart!	Unknown failure caused by abnormality, it is recommended to restart the Robot.
Error 17: Malfunction! Please power OFF.	There is a failure that Robot needs to be shut down. The user is reminded and then Robot is automatically shut down or recharged.
Error 18: Need Charging!	When the battery is extremely low (less than 10%) and it is not on the charging dock, sweeping is triggered.
Error 19: Can't shut down on charging dock	Power OFF is triggered when Robot is charging on charging dock.

When an abnormality occurs during cleaning, the ring indicator red light flashes quickly and the voice prompts. Please refer to the above table to solve the problem.



## Description of Hazardous Material

Toxic and harmful substances and elements	Accessory names					
	Plastic shell	PCB	Power cord	Battery	Metal parts	Adapter
Lead (Pb)	○	×	×	×	○	×
Mercury (Hg)	○	○	○	○	○	○
Cadmium (Cd)	○	○	○	○	○	○
Hexavalent Chromium (Cr(VI))	○	○	○	○	○	○
Polybrominated Biphenyls (PBB)	○	○	○	○	○	○
Polybrominated Diphenyl Ethers (PBDE)	○	○	○	○	○	○

Environmental protection period (EPP): PCB 10 years, power cable 10 years, battery 5 years. EPP means the safety period without any leakage of hazardous substances under instructed use.

○ : All components contain hazardous substances below the directive limit of SJ/T11363-2006.

× : At least one component contains hazardous substances beyond the directive limit of SJ/T11363-2006.



Note: A small patch of electronic components for special purposes is marked with "X" in the table (such as high voltage resistors, ceramic resistors, diodes). Their quantity of Pb may exceed 0.1% due to high-performance consideration. As the core in the screws and in the data cable is made of high-quality alloy, Pb may also exceed 0.1%. All of these items comply with the exemption conditions of EU's RoHS directive, and no alternative technologies or components can be applied at present.

## After-sales Service

---

### Warranty period

The warranty period for Robot and accessories is 1 year. For detailed information, please contact your local authorized dealer.

### Warranty content

Name	Warranty content	Warranty period
Robot	Robot (includes built-in lithium battery)	1 year
Accessories	Charging dock; Power cord; Water tank	1 year
Consumables	Main brush, Side Brush, Main brush cover, Filter, Main brush cleaning tools, Mop, Dust bin	/

Note: consumables included have NO warranty.

### Non-warranty regulations

1. Unauthorized repairs, misuses, collisions, negligence, accidents, modifications, improper use of non-product accessories, etc., or tearing, altering stickers or anti-counterfeiting labels.
2. Beyond the warranty period.
3. Damage caused by force majeure.
4. Does not meet the performance failures listed in the product performance failure table.
5. Due to human reasons, this product and its accessories have performance problems listed in the product performance failure table.

## FCC Warning

---

This equipment has been tested and found to comply with the limits for a Class B digital device, pursuant to part 15 of the FCC Rules. These limits are designed to provide reasonable protection against harmful interference in a residential installation. This equipment generates, uses and can radiate radio frequency energy and, if not installed and used in accordance with the instructions, may cause harmful interference to radio communications. However, there is no guarantee that interference will not occur in a particular installation. If this equipment does cause harmful interference to radio or television reception, which can be determined by turning the equipment off and on, the user is encouraged to try to correct the interference by one or more of the following measures:

- Reorient or relocate the receiving antenna.
- Increase the separation between the equipment and receiver.
- Connect the equipment into an outlet on a circuit different from that to which the receiver is connected.
- Consult the dealer or an experienced radio/TV technician for help.

Caution: Any changes or modifications to this device not explicitly approved by manufacturer could void your authority to operate this equipment.

This device complies with part 15 of the FCC Rules. Operation is subject to the following two conditions: (1) This device may not cause harmful interference, and (2) this device must accept any interference received, including interference that may cause undesired operation.

This equipment complies with FCC radiation exposure limits set forth for an uncontrolled environment. This equipment should be installed and operated with minimum distance 20cm between the radiator and your body.

This transmitter must not be co-located or operating in conjunction with any other antenna or transmitter.

## Warranty Card

---

### User's Information

Name \_\_\_\_\_ Tel. \_\_\_\_\_

E-mail \_\_\_\_\_ Post/Zip Code \_\_\_\_\_

Address \_\_\_\_\_

### Product Information

Model \_\_\_\_\_

Color \_\_\_\_\_

Serial No. \_\_\_\_\_

## Service Record

---

Service record	Failure information	Service date	Service technician signature



Scan QR code to download 360Smart APP



材质:105g哑粉

尺寸:183x125mm

装订方式:骑马钉、28P