

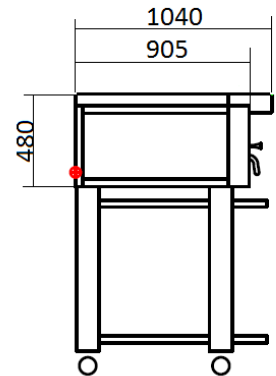

PM 721 ED

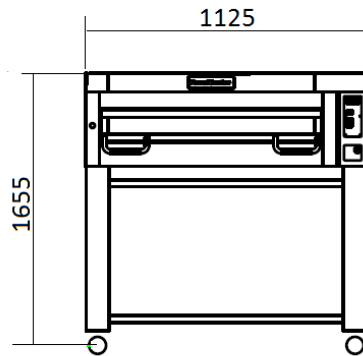

TECHNICAL INFORMATION

Category	700 Series (optimizes for pizzas up to 14 in)
Type	Free Standing
Construction	Stainless steel front
Colour	Classic Silver (Standard), Royal Gold (option), Phantom Black (Option)
Max. working temperature	400 ⁰ C, 500 ⁰ C (Option)
Weight (kg)	215
External Dimensions W x D x H (mm)	1125 x 905 x 480
Internal Dimensions W x D x H (mm)	710 x 710 x 210 / 245 (Option)
Decks (special clay hearthstone)	1
Power connection	3 Phase, 400V, 50Hz,
Power consumption (kw)	6.7
Rated current (A)	10
Capacity (pizzas per deck) 10 in	6
Capacity (pizzas per deck) 14 in	4
Capacity (pizzas per deck) 16 in	2
Capacity (pizzas per deck) 18 in	1
Digital control panel	Standard
Timer with manual shut-off alarm	Standard
Auto-Timer with alarm	Standard
Turbo start function	Standard
Legs with lockable castors	Standard
Stainless steel retractable shelf	Standard

