

GC1RGD

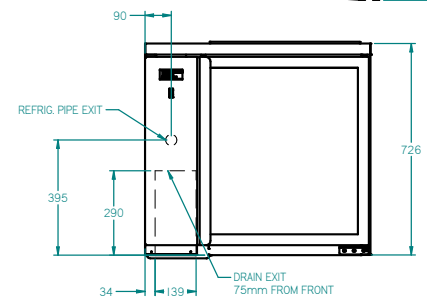

CATEGORY	GENERAL COUNTERS & BACK BARS
RANGE	Glass chiller
UNIT	REFRIGERATOR
TYPE	REMOTE
DOORS	1

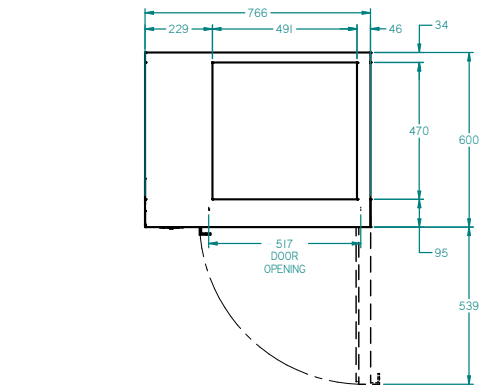
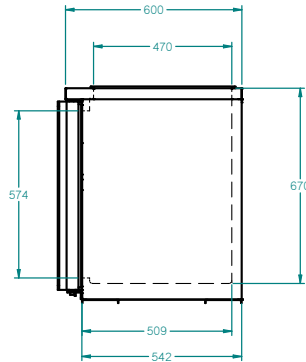

SPECIFICATIONS

CAPACITY - BASKETS/DOOR (NOT INCLUDED) (BASED ON 150MM H GLASSES)	3 Baskets
TEMPERATURE	1°C / 4°C
SHELF LOAD	YES
DIMENSIONS - W X D X H (ON 150MM H LEGS) MM	766 W x 600 D x 875 H
WEIGHT UNPACKED (KG)	60

STANDARD INCLUSIONS ***

DOOR TYPE	Standard: GD (Glass Door)
FINISH (INTERIOR AND EXTERIOR EXCLUDING REAR AND UNDER)	SS (Stainless Steel)
SHELVES/DOOR - SHELF LOAD MODEL ONLY	2

ELECTRICAL

POWER SUPPLY	10 amp
POWER CABLE LENGTH (METRES)	2
RUNNING AMPS	0.4

GAS TYPE

REFRIGERANT	R404a
-------------	-------

REFRIGERATION WATTAGES FOR REMOTE UNITS

REMOTE WATTAGES	570 @ -5° C SST
-----------------	-----------------

*** For **OPTIONS** refer to the current Williams Price Guide