



Husqvarna®



**DISTRIBUTION CATALOG 2021**  
**CONSTRUCTION PRODUCTS**

# How to Use This Interactive Catalog

Welcome to the 2021 Husqvarna Interactive Catalog. Our key source of product information, available with a few clicks. This catalog was developed to be resourceful, informational, and user friendly. Below you will find information on how to use our interactive catalog to get the best experience. Let's dive in!

**Bookmarks** - To quickly find products, open the Bookmark tab. This is your main tool for moving through the catalog. Each product has its own bookmark (excluding diamond tools) making it easy to jump from one product to another in seconds. The table of contents on page 13 is also interactive and links to the beginning of each product section. If you are viewing it in Adobe Acrobat the icon should be on the left hand side and look like a banner with a triangle cut off of the bottom. If your viewing it through a web browser it should appear in the top right hand corner.

## Adobe Acrobat



## Internet Browser



**Product Photos** - Each product page also has numerous interactive elements. Each product photo is linked to corresponding product page on our website. If you need additional product information, spare parts lists or spec sheets just click on the product image. Internet connection required.

**Logos** - Every logo found throughout the catalog (PRIME, HUSQVARNA FLEET, HIPERFLOOR, HUSQVARNA, etc) is interactive, and will take you to the corresponding web pages. Internet connection required.

**Warranty Circles** - To access our warranty information click on one of the products warranty circles. It will direct you to our website and all warranty information. Internet connection required.

**Call out Banners (Blue)** - At the bottom of several pages, you'll find a blue colored rectangle calling out product videos or other product information. Click on the rectangle to visit the website. Internet connection required.

**Call out Banners (Black)** - Click the underlined text to jump to the call out.

**Husqvarna Website/Catalog Links** - At the bottom of each page is an interactive link to the Husqvarna website (even-numbered pages) and Husqvarna Catalog page (odd-numbered pages). Giving you quick access to additional resources.





## Husqvarna Service Centers

### US SERVICE CENTERS

#### CORONA AREA SERVICE CENTER

520 East Rincon St., Ste. 101 Corona, CA 92879  
Office: 951-893-4415 Hours: 8:00 a.m. - 4:30 p.m.

#### CHICAGO AREA SERVICE CENTER

180 Stanley St., Elk Grove Village, IL 60007  
Office : 847-378-1330 Hours: 7:30 a.m. - 4:00 p.m.

#### DALLAS SERVICE CENTER

2933 Eisenhower St., Ste. 160, Carrollton, TX 75007  
Office: 214-351-9990 Hours: 7:00 a.m. - 4:00 p.m.

#### OLATHE SERVICE CENTER

17400 West 119th Street Olathe, KS 66061  
Office: 913-928-1471 Hours: 7:00 a.m. - 3:30 p.m.

#### NEW HAVEN SERVICE CENTER

6 Sycamore Way, Unit 2, Branford, CT 06405  
Office: 203-433-3491 Hours: 7:30 a.m. - 4:00 p.m.

#### ATLANTA SERVICE CENTER

6650 Oak Ridge Commerce Way, Austell, GA 30168  
Office: 770-948-0658 Hours: 8:00 a.m. - 4:30 p.m.

### CANADA SERVICE CENTERS

#### QUEBEC SERVICE CENTER

9430 Rte Trans Canadienne St. Laurent, Quebec H4S 1R7  
P: 514-335-9769 | Hours: 7:30 a.m. - 4:30 p.m.

#### ONTARIO SERVICE CENTER

850 Matheson Blvd. Mississauga, Ontario L5V 0B4  
P: 905-817-8012 | Hours: 8:00 a.m. - 5:00 p.m.

#### BRITISH COLUMBIA SERVICE CENTER

1515 Broadway St., Unit 504, Port Coquitlam, British Columbia V3C 6M2  
P: 604-944-0532 | Hours: 8:00 a.m. - 5:00 p.m.

#### ALBERTA SERVICE CENTER

3510 29th St. NE, Calgary, Alberta T1Y 6Z8  
P: 403-717-0716 | Hours: 7:30 a.m. - 4:30 p.m.

## Customer Service Centers

USA Customer Service & Technical Service: 800-288-5040 | Canada Customer Service: 800-461-9589

**MORE HUSQVARNA  
UPDATES & NEWS  
COMING SOON!**



**MORE HUSQVARNA  
UPDATES & NEWS  
COMING SOON!**

# WE'LL KEEP YOU INFORMED ONLINE

## SUBSCRIBE TO OUR YOUTUBE CHANNEL

Watching our high-quality videos is one of the best ways to find out the features and benefits of our products, as well as getting useful tips and hints on usage, maintenance and repair procedures for your Husqvarna equipment. Stay tuned for our latest video updates by subscribing to our YouTube channel!  
[www.youtube.com/HusqvarnaCP](http://www.youtube.com/HusqvarnaCP)

## USER GUIDES ONLINE

Ever wondered how to get the most out of your Husqvarna equipment? Then it's time to visit the UpServices section on our website! There you'll find our interactive user guides, packed with short video clips showing best practices. The place to go to learn and be inspired! (Memorizing the operator's manual first is of course mandatory too)

## NEW CUSTOMER PORTAL

The new portal includes an improved overview of our product range, spare parts and documents, marketing materials and more. To sign up, contact customer service





### VISIT OUR WEBSITE

Here you'll find updated information on our machines and diamond tools, including complete product technical data, service literature, user manuals, an interactive tool guide, news and much more. You'll also find news and information from our company and your local organization, such as Service Centers and authorized dealers.

[www.husqvarnacp.com](http://www.husqvarnacp.com)



### HUSQVARNA CONSTRUCTION CATALOG FOR iPad

The future is digital, and so is this product catalog. The new iPad app version is the foremost source of product updates from Husqvarna for news-seeking construction professionals. Browse the complete product range, find the latest technical specifications for your favorite Husqvarna equipment and e-mail your order directly to your Husqvarna representative. Download it for free from App Store today!



### FOLLOW US ON FACEBOOK

Don't miss if you're in business! On our Facebook page you can get in touch with us at Husqvarna, and meet Husqvarna users from all over the world. Tell us what you think of our products and services, share your own stories and watch exclusive pics and videos from our trade shows and other Husqvarna events.

[www.facebook.com/HusqvarnaConstruction](http://www.facebook.com/HusqvarnaConstruction)



### PICK UP YOUR SMARTPHONE

Our mobile website provides constant access to updated product information and useful support for your equipment, including an interactive tool guide to help you find the right tool for your job, a library of instructional videos, a searchable archive of user manuals for the machines in PDF format, and contact details of all our dealers.

[www.husqvarnacp.com](http://www.husqvarnacp.com)



# WE'RE EXPERTS IN DIAMOND TOOLS – SO YOU DON'T HAVE TO BE

Husqvarna is one of the world's leading developers and manufacturers of diamond tools for cutting and drilling in concrete and other construction materials. We supply millions of diamond tools – saw blades, drill bits, wires and grinding tools – to professional contractors, craftsmen and rental companies all over the world. A Husqvarna diamond tool is always a safe choice. If you're not sure which tool to pick for a specific job, just follow our recommendation charts at the beginning of each diamond tool section or consult your Husqvarna sales contact.

## BLADE QUALITY LEVELS

### GOLD

Husqvarna Gold level diamond tools are developed for specialist contractors. Made for intensive professional use in specialist applications. Provide maximum cutting speed and wear resistance in heavy cutting, grinding and drilling.

### SILVER

Husqvarna Silver level diamond tools are developed for general contractors. Made for professional use in all-round applications. Provide high cutting speed and wear resistance in all cutting, grinding and drilling.

### BRONZE

Husqvarna Bronze level diamond tools are developed for occasional users. Made to provide a good balance between performance and price in all common cutting and drilling applications.

## HOW TO READ BLADE PACKAGING

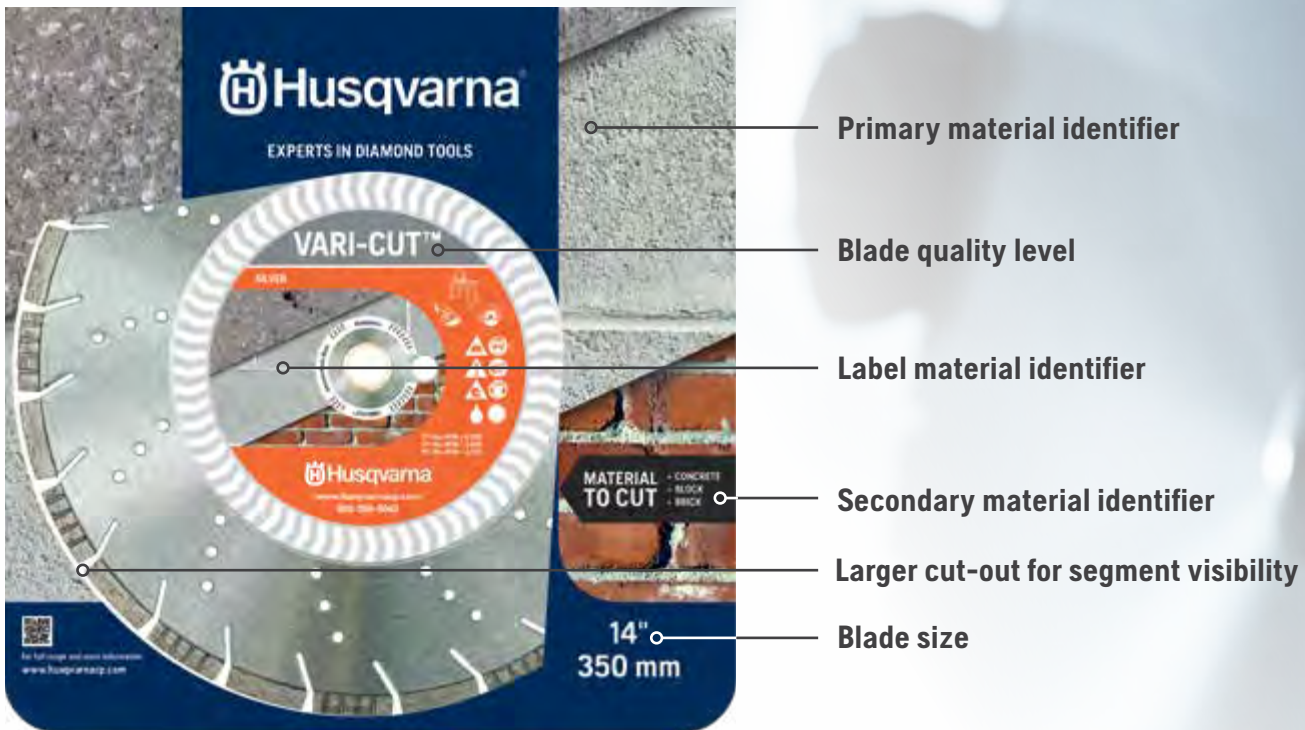



# 5 STEPS FOR SELECTING THE RIGHT DIAMOND BLADE

## 1. WHAT MATERIAL ARE YOU CUTTING?

Correctly identifying the material to be cut directly affects the cutting speed and the life of the blade. Most blades are designed to cut a range of materials, which is limited by the hardness of the bond and the diamond quality used. However, for maximum performance, the blade should be matched as closely as possible to the material it will cut.

## 2. WHAT TYPE OF EQUIPMENT ARE YOU USING?

Knowing if you will be using a 5 hp power cutter or a 70 hp flat saw will impact blade choice dramatically. The size of the blade acceptable to use on the saw, the ability to use a wet or dry blade and the rpms needed to spin the blade all depend on the equipment.

## 3. HOW DEEP ARE YOU CUTTING?

Knowing how deep you need to cut on a particular job will help you select the right blade diameter. Maximum cutting depths listed on blade packaging may vary from what it actually cuts in the field. Actual cutting depth will vary with the exact blade diameter or saw type or the exact diameter of the blade collars (flanges). Cutting depth will also be reduced if saw components (motor housing and blade guard) extend below the blade collars.

## 4. ARE YOU CUTTING DRY OR WET?

Knowing whether or not you will have or need a water source on a job is important when selecting a diamond blade. Blades designed to cut dry can also cut equally well wet, but wet cutting blades absolutely must be used with water.

## 5. DO YOU WANT MORE LIFE OR SPEED?

Which is more important: the initial price of the blade or the cost per cut? It may be more cost effective to purchase a low-priced blade for a smaller job or occasional use. For larger jobs or more regular use, a higher priced blade will actually be less expensive to use because it will deliver the lowest cost per cut.

To learn more about diamond tools visit:  
[www.husqvarnacp.com](http://www.husqvarnacp.com)

# THE BEST WAY OF WORKING COMES FROM EXPERIENCE AND EXCELLENT EQUIPMENT

Whether you're an experienced concrete cutter or a newcomer to the game, you'll appreciate the reliable power and versatility provided by the all-new PRIME™ equipment from Husqvarna.

In fact, we believe that the more experience you have from various cutting jobs and equipment setups, the more you will appreciate this new generation of PRIME™ equipment.

Why? Because it combines the simplicity, user-friendliness and low weight of electrical systems with the advantages of hydraulic systems. But without the heavy hoses or the risk of oil spills. All of which adds up to you getting more done in a day at work.

Since the PRIME™ product range was introduced in 2013, it has been expanded and refined throughout. Now it's time to introduce a new generation, built around the all-new, intelligent and extremely sturdy Husqvarna PP 70 power pack.

A new generation of PRIME™ equipment, with all of Husqvarna's knowledge and experience built in.



Powerful.  
Revolutionary.  
Intelligent.  
Modular.  
Electric.









# SMART SOLUTIONS THAT MAKE A DIFFERENCE

FINDING SOLUTIONS TO YOUR CHALLENGES IS WHAT WE STRIVE TO DO. WHEN YOU PARTNER WITH HUSQVARNA, WE WILL BE THERE TO SUPPORT YOU IN ANY WAY POSSIBLE. TOGETHER WE WILL FIND A SMARTER WAY TO WORK.

All Husqvarna Construction Products production facilities are certified according to ISO 9001 and 14001. Husqvarna Construction Products is member of the oSa, the Organization for the Safety of Abrasives.



PRODUCT INFORMATION, UPDATES & NEWS	2
FLAT SAWS DIAMOND BLADES FOR FLAT SAWS	<u>14</u> <u>32</u>
POWER CUTTERS DIAMOND BLADES FOR POWER CUTTERS	<u>48</u> <u>74</u>
COMPACTION EQUIPMENT	<u>84</u>
CONCRETE PLACEMENT EQUIPMENT	<u>98</u>
SOFF-CUT® ULTRA EARLY ENTRY™ SAWS DIAMOND BLADES FOR ULTRA EARLY ENTRY™ SAWS	<u>120</u> <u>132</u>
DRILL MOTORS AND STANDS DIAMOND CORE BITS	<u>140</u> <u>158</u>
SURFACE PREPARATION DIAMOND TOOLS FOR SURFACE PREPARATION	<u>172</u> <u>192</u>
DUST AND SLURRY MANAGEMENT PULLMAN HOLT VACUUMS	<u>214</u> <u>228</u>
MASONRY SAWS DIAMOND BLADES FOR MASONRY SAWS	<u>236</u> <u>244</u>
SMALL DIAMETER BLADES	<u>248</u>
REMOTE DEMOLITION EQUIPMENT ATTACHMENTS	<u>256</u> <u>268</u>
PROTECTIVE EQUIPMENT	<u>278</u>
TECHNICAL DATA	<u>282</u>

We reserve the right to make changes in technology, specifications and pricing without prior notice.  
For MAPP, freight and warranty information please visit the support section of our website.

# WHERE INNOVATIVE ENGINEERING MEETS TOUGH PRODUCTIVITY DEMANDS

In walk-behind flat sawing, maximum productivity can only be achieved by a well thought out and balanced formula of power, ergonomics, torque, maneuverability and reliability. All factors must work efficiently together to get the most out of your working day. It's about the interaction between you, the machine and the diamond blade as a whole. This is what makes Husqvarna flat saws the ideal choice for maximum productivity.



## Count on productivity Cut off emissions

The FS 7000 DL, FS 7000 D and 5000 D flat saws are faster, cleaner and smarter. The powerful modern diesel engines are low-emissions compliant with EPA Tier 4 and provide fast, efficient sawing. Models are available with a 3-speed, right angle gearbox, which enables different blade sizes to run optimally without changing pulleys or belts. The intuitive digital control panel and other smart features help you work more efficiently.

## Range Overview

The complete range of Husqvarna flat saws consists of 15 models with cutting depths from 4-5/8" (125 mm) to 25" (635 mm), powered by engines from 8.5 hp gas to 74 hp diesel, weighing from 117 lb to 2,872 lb. All of our flat saws provide class-leading power and torque at the bladeshaft, which means greater productivity when deep sawing. Below you can easily find the flat saw that provides you with the highest production rate.

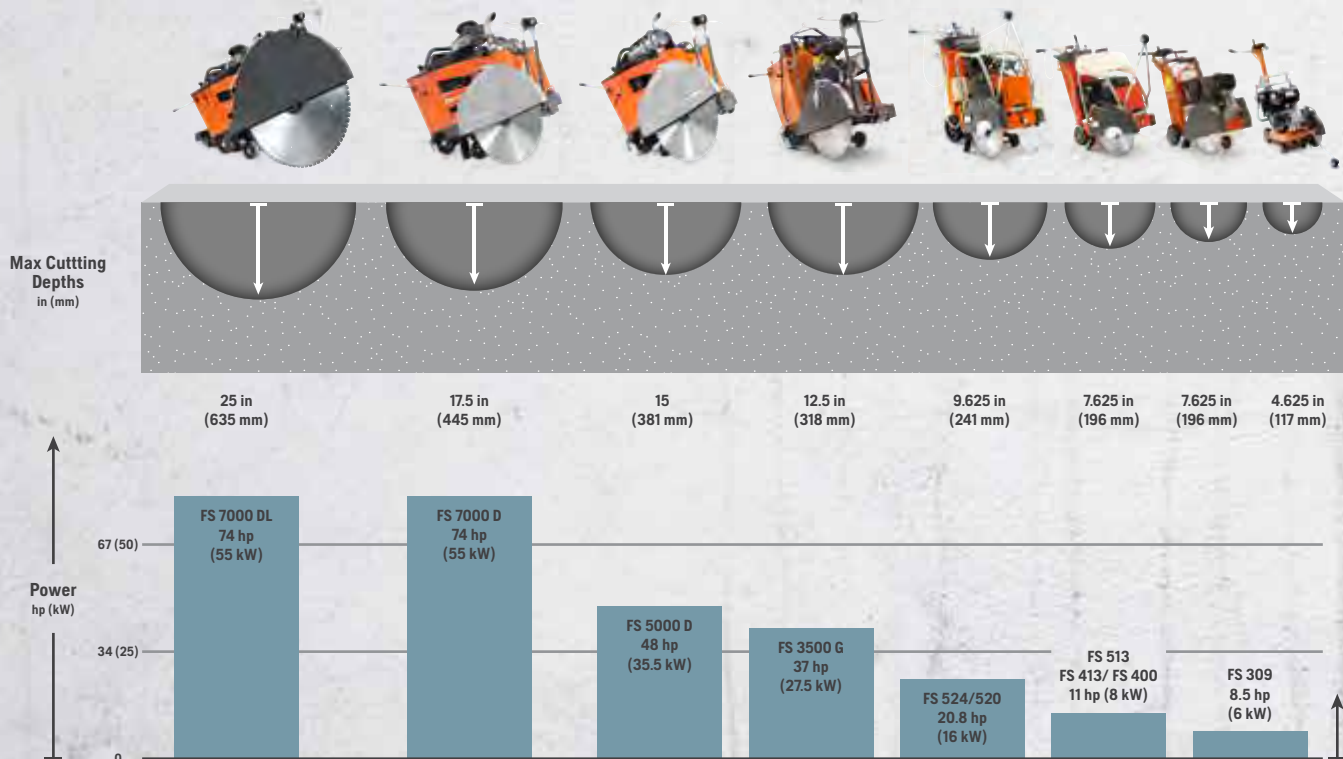





**Ergonomic** - The handlebars are adjustable to suit every operator's preference, while the layout of the controls allows for intuitive operation. All saws are developed to be highly maneuverable with low vibrations - ultimately reducing user fatigue.

**Low Maintenance** - Most Husqvarna flat saws feature the patented IntelliSeal blade shaft system. It allows up to 250 maintenance-free hours without daily greasing of blade shaft bearings.

**Straight Cuts** - On the FS 5000 D and FS 7000 D models, the operator-friendly control panel includes a digital monitor with Electronic Tracking Assistance mode. This facilitates making highly productive straight cuts while minimizing strain on the operator.



**Water Valve** - New additional on/off water valve on control panel to regulate water flow while you cut. Available on the FS 7000 DL, FS 7000 & FS 5000.

# Husqvarna FS 7000 DL



FLAT SAWS

## Applications

- Large jobs such as airports, highways, larger service work and other applications where production is a priority.
- Projects requiring deep sawing and/or large blade applications.

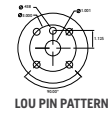

## Benefits

- Tier 4 compliant engine meets current EPA regulations.
- New additional on/off water valve located on the right-hand side of the control panel regulates water flow.
- 3-speed, right-angle gearbox models enable different blade sizes to run at their optimal performance level without changing pulleys or belts.
- Digital display dashboard features all important functions and is easy to monitor. Maintenance intervals can be set for service reminders.
- E-track system with an integrated reset function in the display makes it easier to produce a straight cut.
- Heavy-duty blade shaft to handle large blades.
- 5-pin blade flanges with standard single pin featuring LOU pin pattern.



Gearbox Models	3-SPEED	3-SPEED	3-SPEED	3-SPEED
FS Models	FS 7000 DL 36"	FS 7000 DL 42"	FS 7000 DL 48"	FS 7000 DL 60"
Part No. (E-tracking)	967056006	967056005	967056003	967056001

## Technical Specifications

Maximum blade diameter, in (mm)	36 (914)	42 (1,067)	48 (1,219)	60 (1,524)
Maximum depth of cut, in (mm)	15 (381)	17.5 (444.5)	20 (508)	25 (635)
Average bladeshaft, rpm	1,387/1,626/2,331	1,180/1,380/1,960	1,035/1,211/1,741	850/990/1,430
Blade range, in (mm)	26/30/36 (660/762/914)	30/36/42 (762/914/1,067)	36/42/48 (914/1,067/1,219)	42/48/60 (1,067/1,219/1,524)
Blade flanges, in (mm)	6 (152)	7 (178)	8 (203)	10 (254)
Maximum weight crated, lbs (kgs)	2,405 (1,091)	2,455 (1,114)	2,462 (1,117)	2,987 (1,355)
Maximum weight uncrated, lbs (kgs)	2,290 (1,039)	2,340 (1,061)	2,347 (1,065)	2,872 (1,303)

Engine Specifications	Deutz C4D155.4	Blade guard type	Slip-on
Maximum power, hp (kW)*	74 (55)	Number of belts	16 (Set of 4, banded belts)
Power at bladeshaft, hp (kW)	66 (48)	Blade depth control	Electro-hydraulic pump
Arbor size, in (mm)	1 (25)	Dimensions uncrated, pointer and blade guard up, handles, in (mm) L x W x H	60"-107 x 38 x 59 (2,710 x 974 x 1,499) 36"-48" 93 x 38 x 59 (2,370 x 974 x 1,499)
Bladeshaft diameter, in (mm)	2.5 (63)	Displacement, cu in (l)	178 (2.92)
Cylinders/cycle	4/4	Bore/stroke, in (mm)	3.6/4.3 (91/109)
Fuel capacity, gal (l)	10.6 (40)	Oil capacity, qt (l)	9 (8.5)
Air filter	Dual element radial seal with rain hood	Handlebar adjustment	Variable position
Starter	Electric	Transmission type	Balanced dual motor hydrostatic drive
Engine cooling	Liquid/air	Transmission speeds, fpm	0-300
Axle front/rear, in (mm)	1 (25)	Electric tracking (optional)	Electric switch operated
Wheels front, in (mm)	8 x 3 (203 x 76)		
Wheels rear, in (mm)	10 x 3 (254 x 76)		

\*As rated by the engine manufacturer.

RECOMMENDED DIAMOND TOOLS

F900 & F1500 Series



# Husqvarna FS 7000 DL



## Applications

- Large jobs such as airports, highways, larger service work and other applications where production is a priority.
- Projects requiring deep sawing and/or large blade applications.

## Benefits

- Tier 4 compliant engine meets current EPA regulations.
- New additional on/off water valve located on the right-hand side of the control panel regulates water flow.
- Digital display dashboard features all important functions and is easy to monitor. Maintenance intervals can be set for service reminders.
- E-track system with an integrated reset function in the display makes it easier to produce a straight cut.
- Heavy-duty blade shaft to handle large blades.
- 5-pin blade flanges with standard single pin featuring LOU pin pattern.

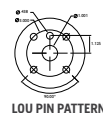

LOU PIN PATTERN



Gearbox Models	1-SPEED	1-SPEED
FS Models	FS 7000 DL 48"	FS 7000 DL 60"
Part No. (E-tracking)	967056004	967056002
Part No. (E-tracking, Blade clutch)	967056018	-

## Technical Specifications

Maximum blade diameter, in (mm)	48 (1,219)	60 (1,524)
Maximum depth of cut, in (mm)	20 (508)	25 (635)
Average bladeshaft, rpm	1,052	815
Blade flanges, in (mm)	8 (203)	10 (254)
Maximum weight crated, lbs (kgs)	2,421 (1,098)	2,923 (1,326)
Maximum weight uncrated, lbs (kgs)	2,306 (1,046)	2,808 (1,274)

Engine Specifications	Deutz C4D155.4	Blade guard type	Slip-on
Maximum power, hp (kW)*	74 (55)	Number of belts	16 (Set of 4, banded belts)
Power at bladeshaft, hp (kW)	66 (48)	Blade depth control	Electro-hydraulic pump
Arbor size, in (mm)	1 (25)	Dimensions uncrated, pointer and blade guard up, handles, in (mm) L x W x H	60"-107 x 38 x 59 (2,710 x 974 x 1,499) 36"-48" 93 x 38 x 59 (2,370 x 974 x 1,499)
Bladeshaft diameter, in (mm)	2.5 (63)	Displacement, cu in (l)	178 (2.92)
Cylinders/cycle	4/4	Bore/stroke, in (mm)	3.6/4.3 (91/109)
Fuel capacity, gal (l)	10.6 (40)	Oil capacity, qt (l)	9 (8.5)
Air filter	Dual element radial seal with rain hood	Handlebar adjustment	Variable position
Starter	Electric	Transmission type	Balanced dual motor hydrostatic drive
Engine cooling	Liquid/air	Transmission speeds, fpm	0-300
Axle front/rear, in (mm)	1 (25)	Electric tracking (optional)	Electric switch operated
Wheels front, in (mm)	8 x 3 (203 x 76)		
Wheels rear, in (mm)	10 x 3 (254 x 76)		

\*As rated by the engine manufacturer.

**RECOMMENDED DIAMOND TOOLS**

**F900 & F1500 Series**

# Husqvarna FS 7000 D



FLAT SAWS

## Applications

- Large jobs such as airports, highways, larger service work, and other applications where production is a priority.
- Mid-size jobs that require high production rates.

## Benefits

- Tier 4 compliant engine meets current EPA regulations.
- New additional on/off water valve located on the right-hand side of the control panel regulates water flow.
- Power transmission system transmits more power to the bladeshaft with optimum torque.
- 3-speed, right-angle gearbox models enable different blade sizes to run at their optimal performance level without changing pulleys or belts.
- Digital display dashboard features all important functions and is easy to monitor.
- Maintenance intervals can be set for service reminders.
- E-track system option has an integrated reset function in the display making it easier to produce a straight cut.
- 5-pin blade flanges with standard single pin featuring LOU pin pattern.

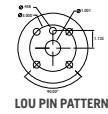

Gearbox Models	3-SPEED	3-SPEED	3-SPEED	3-SPEED
FS Models	FS 7000 D 26"	FS 7000 D 30"	FS 7000 D 36"	FS 7000 D 42"
Part No.	967207925	967207929	967207933	967207937
Part No. (E-tracking)	967207926	967207930	967207934	967207938
Part No. (Blade clutch)	-	-	967182401	967207959
Part No. (E-tracking, Blade clutch)	-	-	967182402	967207961

## Technical Specifications

Maximum blade diameter, in (mm)	26 (660)	30 (762)	36 (914)	42 (1,067)
Maximum depth of cut, in (mm)	10.5 (267)	12.5 (305)	15 (381)	17.5 (445)
Average bladeshaft, rpm	1,860/2,170/3,100	1,600/1,880/2,680	1,360/1,620/2,300	1,180/1,380/1,960
Blade range, in (mm)	14/18/26 (350/450/660)	18/26/30 (450/660/762)	20/30/36 (508/762/914)	30/36/42 (762/914/1,067)
Blade flanges, in (mm)	5 (127)	5 (127)	6 (152)	7 (178)
Maximum weight crated, lbs (kgs)	2,256 (1,023)	2,265 (1,027)	2,278 (1,033)	2,417 (1,096)
Maximum weight uncrated, lbs (kgs)	2,146 (973)	2,155 (977)	2,168 (983)	2,307 (1,046)

Engine Specifications	Deutz C4D155.4	Blade guard type	Slip-on
Maximum power, hp (kW)*	74 (55)	Number of belts	16 (Set of 4, banded belts)
Power at bladeshaft, hp (kW)	66 (48)	Blade depth control	Electrohydraulic pump
Arbor size, in (mm)	1 (25)	Dimensions uncrated, pointer and blade guard up, handles, in (mm) L x W x H	67 x 38 x 57 (1,701 x 965 x 1,448)
Bladeshaft diameter, in (mm)	2 (51)	Displacement, cu in (l)	178 (2.92)
Cylinders/cycle	4/4	Bore/stroke, in (mm)	3.6/4.3 (91/109)
Fuel capacity, gal (l)	10.6 (40)	Oil capacity, qt (l)	9 (8.5)
Air filter	Dual element radial seal with rain hood	Handlebar adjustment	Variable position
Starter	Electric	Transmission type	Balanced dual motor hydrostatic drive
Engine cooling	Liquid/air	Transmission speeds, fpm	0-300
Axle front/rear, in (mm)	1 (25)	Electric tracking (optional)	Electric switch operated
Wheels front, in (mm)	8 x 3 (203 x 76)		
Wheels rear, in (mm)	10 x 3 (254 x 76)		

\*As rated by the engine manufacturer.

**RECOMMENDED DIAMOND TOOLS**

**F900 & F1500 Series**



# Husqvarna FS 7000 D



## Applications

- Large jobs such as airports, highways, larger service work, and other applications where production is a priority.
- Mid-size jobs that require high production rates.

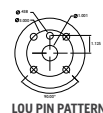

## Benefits

- Tier 4 compliant engine meets current EPA regulations.
- New additional on/off water valve located on the right-hand side of the control panel regulates water flow.
- Power transmission system transmits more power to the bladeshaft with optimum torque.
- Digital display dashboard features all important functions and is easy to monitor.
- Maintenance intervals can be set for service reminders.
- E-track system option has an integrated reset function in the display making it easier to produce a straight cut.
- 5-pin blade flanges with standard single pin featuring LOU pin pattern.



Gearbox Models	1-SPEED	1-SPEED	1-SPEED	1-SPEED	1-SPEED
FS Models	FS 7000 D 20"	FS 7000 D 26"	FS 7000 D 30"	FS 7000 D 36"	FS 7000 D 42"
Part No.	967207901	967207903	967207909	967207915	967207921
Part No. (E-tracking)	967207902	967207904	967207910	967207916	967207922
Part No. (Blade clutch)	-	967182403	967207956	-	697207958
Part No. (E-tracking, Blade clutch)	-	967207905	967207911	967207917	-

## Technical Specifications

Maximum blade diameter, in (mm)	20 (508)	26 (660)	30 (762)	36 (914)	42 (1,067)
Maximum depth of cut, in (mm)	7-5/8 (196)	10.5 (267)	12.5 (305)	15 (381)	17.5 (445)
Average bladeshaft, rpm	2,362	1,762	1,624	1,354	1,150
Blade flanges, in (mm)	4.5 (114)	5 (127)	5 (127)	6 (152)	7 (178)
Maximum weight crated, lbs (kg)	2,213 (1,004)	2,224 (1,009)	2,233 (1,013)	2,246 (1,019)	2,385 (1,082)
Maximum weight uncrated, lbs (kg)	2,103 (954)	2,114 (959)	2,123 (963)	2,136 (969)	2,275 (1,032)

Engine Specifications	Deutz C4D155.4	Blade guard type	Slip-on
Maximum power, hp (kW)*	74 (55)	Number of belts	16 (Set of 4, banded belts)
Power at bladeshaft, hp (kW)	66 (48)	Blade depth control	Electrohydraulic pump
Arbor size, in (mm)	1 (25)	Dimensions uncrated, pointer and blade guard up, handles, in (mm) L x W x H	67 x 38 x 57 (1,701 x 965 x 1,448)
Bladeshaft diameter, in (mm)	2 (51)	Displacement, cu in (l)	178 (2.92)
Cylinders/cycle	4/4	Bore/stroke, in (mm)	3.6/4.3 (91/109)
Fuel capacity, gal (l)	10.6 (40)	Oil capacity, qt (l)	9 (8.5)
Air filter	Dual element radial seal with rain hood	Handlebar adjustment	Variable position
Starter	Electric	Transmission type	Balanced dual motor hydrostatic drive
Engine cooling	Liquid/air	Transmission speeds, fpm	0-300
Axle front/rear, in (mm)	1 (25)	Electric tracking (optional)	Electric switch operated
Wheels front, in (mm)	8 x 3 (203 x 76)		
Wheels rear, in (mm)	10 x 3 (254 x 76)		

\*As rated by the engine manufacturer.

**RECOMMENDED DIAMOND TOOLS**

**F900 & F1500 Series**

# Husqvarna FS 5000 D



FLAT SAWS

## Applications

- Large jobs such as airports, highways, larger service work, and other applications where production is a priority.
- Mid-size jobs that require high production rates.

## Benefits

- Tier 4 compliant engine meets current EPA regulations.
- New additional on/off water valve located on the right-hand side of the control panel regulates water flow.
- Blade diameters up to 36" provides maximum cutting depth of 15".
- 3-speed gearbox models enable different blade sizes to run at their optimal performance level without changing pulleys or belts.
- Optional E-track system with an integrated reset function in the display making it easier to produce a straight cut.
- Power transmission system transmits more power to the bladeshaft with optimum torque.
- Patented IntelliSeal bladeshaft system allows a minimum of 500 maintenance-free hours and eliminates daily greasing of bearings.



Gearbox Models	3-SPEED	3-SPEED	3-SPEED
FS Models	FS 5000 D 26"	FS 5000 D 30"	FS 5000 D 36"
Part No.	967207310	967207316	967207322
Part No. (E-tracking)	967207311	967207317	967207323
Part No. (E-tracking, Blade clutch)	-	-	967207321

## Technical Specifications

Maximum blade diameter, in (mm)	26 (660)	30 (762)	36 (914)
Maximum depth of cut, in (mm)	10.5 (267)	12.5 (305)	15 (381)
Average bladeshaft, rpm	3,100/2,180/1,870	2,660/1,800/1,570	2,260/1,580/1,360
Blade range, in (mm)	14/18/26 (350/450/660)	18/26/30 (450/650/1,762)	20/30/36 (500/750/1,914)
Blade flanges, in (mm)	5 (127)	5 (127)	6 (152)
Maximum weight crated, lbs (kg)	1,821 (826)	1,830 (830)	1,843 (835)
Maximum weight uncrated, lbs (kg)	1,711 (776)	1,725 (782)	1,738 (788)

Engine Specifications	Yanmar 4TNV88C-DH0	Blade guard type	Slip-on
Maximum power, hp (kW)*	48 (35.5)	Number of belts	12
Power at bladeshaft, hp (kW)	42 (31)	Blade depth control	Electro-hydraulic pump
Arbor size, in (mm)	1 (25), single drive pin	Dimensions uncrated, pointer and blade guard up, handles, in (mm) L x W x H	56 x 33-1/4 x 51 (1,422 x 845 x 1,295)
Bladeshaft diameter, in (mm)	2 (51)	Displacement, cu in (l)	133 (219)
Cylinders/cycle	4/4	Bore/stroke, in (mm)	3.5/3.55 (88/90)
Fuel capacity, gal (l)	7.8 (29.5)	Oil capacity, qt (l)	7.8 (7.4)
Air filter	Dual Element Radial Seal with rain hood	Handlebar adjustment	Variable Position
Starter	Electric	Transmission type	Balanced dual motor hydrostatic drive
Engine cooling	Liquid/air	Transmission speeds, fpm	0-300
Axle front/rear, in (mm)	1 (25)	Electric tracking (optional)	Electric switch operated
Wheels front, in (mm)	6 x 2 (152 x 51)		
Wheels rear, in (mm)	10 x 3 (254 x 76)		

\*As rated by the engine manufacturer.

RECOMMENDED DIAMOND TOOLS

F600, F700 & F900 Series



# Husqvarna FS 5000 D



## Applications

- Large jobs such as airports, highways, larger service work, and other applications where production is a priority.
- Mid-size jobs that require high production rates.

## Benefits

- Tier 4 compliant engine meets current EPA regulations.
- New additional on/off water valve located on the right-hand side of the control panel regulates water flow.
- Blade diameters up to 36" provides maximum cutting depth of 15".
- Optional E-track system with an integrated reset function in the display making it easier to produce a straight cut.
- Power transmission system transmits more power to the bladeshaft with optimum torque.
- Patented IntelliSeal bladeshaft system allows a minimum of 500 maintenance-free hours and eliminates daily greasing of bearings.



Gearbox Models	1-SPEED	1-SPEED	1-SPEED	1-SPEED	1-SPEED
FS Models	FS 5000 D 14"	FS 5000 D 20"	FS 5000 D 26"	FS 5000 D 30"	FS 5000 D 36"
Part No.	967207301	967207304	967207307	967207312	967207318
Part No. (E-tracking)	967207302	967207305	967207308	967207313	967207319
Part No. (Blade clutch)	-	-	697207346	967207314	967207320
Part No. (E-tracking, Blade clutch)	967207303	967207306	967207309	967207315	967207321

## Technical Specifications

Maximum blade diameter, in (mm)	14 (350)	20 (508)	26 (660)	30 (762)	36 (914)
Maximum depth of cut, in (mm)	4.75 (121)	7.75 (197)	10.5 (267)	12.5 (305)	15 (381)
Average bladeshaft, rpm	3,197	2,400	1,866	1,628	1,355
Blade flanges, in (mm)	4.5 (114)	4.5 (114)	5 (127)	5 (127)	6 (152)
Maximum weight crated, lbs (kg)	1,761 (799)	1,772 (804)	1,783 (809)	1,792 (813)	1,805 (818)
Maximum weight uncrated, lbs (kg)	1,656 (751)	1,667 (756)	1,678 (761)	1,687 (765)	1,700 (771)

Engine Specifications	Yanmar 4TNV88C-DH0	Blade guard type	Slip-on
Maximum power, hp (kW)*	48 (35.5)	Number of belts	12
Power at bladeshaft, hp (kW)	42 (31)	Blade depth control	Electro-hydraulic pump
Arbor size, in (mm)	1 (25), single drive pin	Dimensions uncrated, pointer and blade guard up, handles, in (mm) L x W x H	56 x 33-1/4 x 51 (1,422 x 845 x 1,295)
Bladeshaft diameter, in (mm)	2 (51)	Displacement, cu in (l)	133 (219)
Cylinders/cycle	4/4	Bore/stroke, in (mm)	3.5/3.55 (88/90)
Fuel capacity, gal (l)	7.8 (29.5)	Oil capacity, qt (l)	7.8 (7.4)
Air filter	Dual Element Radial Seal with rain hood	Handlebar adjustment	Variable Position
Starter	Electric	Transmission type	Balanced dual motor hydrostatic drive
Engine cooling	Liquid/air	Transmission speeds, fpm	0-300
Axle front/rear, in (mm)	1 (25)	Electric tracking (optional)	Electric switch operated
Wheels front, in (mm)	6 x 2 (152 x 51)		
Wheels rear, in (mm)	10 x 3 (254 x 76)		

\*As rated by the engine manufacturer.

**RECOMMENDED DIAMOND TOOLS**

**F600, F700 & F900 Series**

# Husqvarna FS 3500 Gas

## Applications

- Ideal for repair and removal of driveways and sidewalks.

## Benefits

- Improved drive system reduces load on engine.
- Updated quick disconnect blade flanges assist when blade is pinched in a cut.
- Lift bail is standard for easy loading and unloading.
- Dual arbors allow the blade to be mounted on either end of the bladeshaft for right or left cutting.
- Hydraulic raise and lower system reduces operator fatigue and increases production.



Models	Gas	Gas	Gas
FS Models	FS 3500 G 20"	FS 3500 G 26"	FS 3500 G 30"
Part No.	967673701	967673702	967673703

## Technical Specifications

Maximum blade diameter, in (mm)	20 (508)	26 (660)	30 (762)
Maximum depth of cut, in (mm)	7-5/8 (196)	10.5 (267)	12-3/8 (311)
Average bladeshaft, rpm	2,650	1,860	1,860
Maximum weight crated, lbs (kg)	922 (418.2)	933 (423.2)	943 (427.7)

Power source	Kohler CH1000
Maximum power, hp (kW)*	37 (27.5)
Arbor size, in (mm)	1 (25)
Bladeshaft diameter, in (mm)	1-7/16 (36.5)
Cylinders/cycle	2/4
Fuel capacity, gal (l)	6 (28)
Air filter	Heavy canister
Starter	Electric
Engine cooling	Air
Axle front/rear, in (mm)	1 (25.4)
Wheels front, in (mm)	6 x 2 x 1 (152 x 51 x 25.4)
Wheels rear, in (mm)	8 x 2 x 1 (203 x 51 x 25.4)

Blade guard type	Slip-on
Number of belts	25 Rib Poly V Belt
Blade depth control	Electro-hydraulic pump
Dimensions uncrated, pointer and blade guard up, handles, in (mm) L x W x H	56 x 32 x 45 (1,420 x 800 x 1,135)
Displacement, cu in (l)	61 (l)
Bore/stroke, in (mm)	3.5/3.1 (89/79)
Oil capacity, qt (l)	2.9 (2.7)
Handlebar adjustment	Two position
Transmission type	Hydrostatic drive
Transmission speeds, fpm	0-150

\*As rated by the engine manufacturer.

RECOMMENDED DIAMOND TOOLS

F600 SERIES | BANNER LINE®



# Husqvarna FS 3500 Electric

## Applications

- Ideal for medium to small service and repair jobs when cutting concrete or asphalt indoors.
- An electric flat saw perfect for use when no exhaust emissions are permitted.

## Benefits

- Slip-on blade guard has an auto-latch to clamp the guard securely to the saw. It also has a wide, tapered guard spade and a replaceable blade guard hinge to aid in removing and installing the blade guard.
- Lift bail is standard for easy loading and unloading.
- Box frame is the most rigid available and provides long life and less stress on the bladeshaft and bearings.
- Dual arbors allow the blade to be mounted on either end of the bladeshaft for right or left cutting.



Models	Electric	Electric
FS Models	FS 3500 E 26"	FS 3500 E 30"
Part No.	965151828	965151829

## Technical Specifications

Maximum blade diameter, in (mm)	26 (660)	30 (762)
Maximum depth of cut, in (mm)	10.5 (267)	12 (305)
Average bladeshaft, rpm	1750	1600
Maximum weight crated, lbs (kg)	1,465 (656)	1,486 (666)

Power source	Lincoln	Amp rating (full load)	37
Maximum power, hp (kW)*	30 (22)	Axle front/rear, in (mm)	1 (25.4)
Arbor size, in (mm)	1 (25)	Wheels front, in (mm)	6 x 2 x 1 (152 x 51 x 25.4)
Blade flanges, in (mm)	5 (127), 6 (154) 30"	Wheels rear, in (mm)	8 x 2 x 1 (203 x 51 x 25.4)
Bladeshaft diameter, in (mm)	1-7/16 (36.5)	Handlebar adjustment	Multi-position
Voltage, V	480	Blade guard type	Slip-on
Phase	3	Maximum weight uncrated, lbs (kg)	1,160 (526)
Cycle	60	Recommended generator size, kW	65 kW

\*As rated by the engine manufacturer.

RECOMMENDED DIAMOND TOOLS

F600 SERIES | BANNER LINE®

# Husqvarna FS 500 Series

## Applications

- Self-propelled group of saws perfect for cutting sidewalks, driveways and other small repair or service work.

## Benefits

- Patented engine and bladeshaft mounting system reduces vibration for improved cutting performance.
- Patented IntelliSeal bladeshaft system allows for a minimum of 250 maintenance-free hours and eliminates daily greasing of bearings.
- Dual spring assist raise/lower blade can be mounted on left or right side when necessary.
- Belt tensioning system does not require frequent adjustment.
- New locking differential drive system increases blade performance when cutting uneven surfaces.



FS Models	FS 524	FS 520	FS 513
Part No.	967046103	967045902	967045901

## Technical Specifications

Maximum blade diameter, in (mm)	24 (600)	20 (508)	20 (508)
Maximum depth of cut, in (mm)	9-5/8 (244)	7-5/8 (196)	7-5/8 (196)
Average bladeshaft, rpm	2,110	2,110	2,620
Blade flanges, in (mm)	4.5 (114)	4.5 (114)	4.5 (114)
Maximum weight crated, lbs (kg)	589 (267)	580 (263)	511 (232)
Maximum weight uncrated, lbs (kg)	502 (228)	493 (224)	424 (193)

Power source	Honda GX630	Wheels rear, in (mm)	10 x 3 x 7/8 (254 x 76 x 22)
Power source (FS 513)	Honda GX390	Blade guard type	Slip-on with bolt
Maximum power, hp (kW)*	20.8 (16)	Number of belts	16 rib poly v belt
Maximum power, hp (kW)* (FS 513)	11 (8)	Number of belts (FS 513)	12 rib poly v belt
Arbor size, in (mm)	1 (25)	Blade depth control	Spring assist screw feed
Bladeshaft diameter, in (mm)	1-3/16 (30)	Dimensions uncrated, pointer and blade guard up, handles, in (mm) L x W x H	66 x 26 x 42 (1,676 x 660 x 1,067)
Cylinders/cycle	2/4	Displacement, cu in (l)	41.9 (686)
Cylinders/cycle (FS 513)	1/4	Displacement, cu in (l) (FS 513)	23.7 (389)
Fuel capacity, gal (L)	2.2 (8.3)	Bore/stroke, in (mm)	3.07/2.83 (78/72)
Fuel capacity, gal (L) (FS 513)	1.6 (6.1)	Bore/stroke, in (mm) (FS 513)	3.50/2.5 (89/64)
Air filter	Dry Type Canister	Oil capacity, qt (L)	2 (1.9)
Air filter (FS 513)	Dry type dual element cyclone	Oil capacity, qt (L) (FS 513)	1.2 (1.1)
Starter	Electric	Handlebar adjustment	Variable position
Starter (FS 513)	Recoil	Transmission type	Hydrostatic trans-axle
Engine cooling	Air	Transmission speeds, fpm	0-80
Axle front/rear, in (mm)	3/4 (19)		
Wheels front, in (mm)	5 x 1.5 x 3/4 (127 x 38 x 19)		

\*As rated by the engine manufacturer.

**RECOMMENDED DIAMOND TOOLS**

**VARI-CUT™ PLUS | BANNER LINE®**



# Husqvarna FS 413

## Applications

- Handles medium to small service work and repair jobs in concrete or asphalt. Perfect for rental.

## Benefits

- A push saw with a clear focus on ergonomics, which reduces operator fatigue.
- Patented engine and bladeshaft mounting system reduces vibration for improved cutting performance.
- Patented IntelliSeal bladeshaft system allows for a minimum of 250 maintenance-free hours and eliminates daily greasing of bearings.
- The spring-assist screw feed adjustment feature reduces the force required to raise and lower the blade in and out of the cut.
- Compact and easy to transport.



FS Models	FS 413
Part No. (shown with optional water tank)	965150107

## Technical Specifications

Maximum blade diameter, in (mm)	20 (508)
Maximum depth of cut, in (mm)	7-5/8 (196)
Average bladeshaft, rpm	2,620
Blade flanges, in (mm)	4.5 (114)
Maximum weight crated, lbs (kg)	379 (172)
Maximum weight uncrated, lbs (kg)	306 (139)

Power source	Honda GX390	Blade guard type	Slip-on with bolt
Maximum power, hp (kW)*	11 (8)	Number of belts	12 rib poly v belt
Arbor size, in (mm)	1 (25)	Blade depth control	Spring assist screw feed
Bladeshaft diameter, in (mm)	1-3/16 (30)	Dimensions uncrated, pointer and blade guard up, handles in, in (mm) L x W x H	66 x 26 x 42 (1,676 x 660 x 1,067)
Cylinders/cycle	1/4	Displacement, cu in (l)	237 (389)
Fuel capacity, gal (l)	1.6 (6.1)	Bore/stroke, in (mm)	3.50/2.5 (89/64)
Air filter	Dry type dual element cyclone	Oil capacity, qt (l)	1.2 (1.1)
Starter	Recoil	Handlebar adjustment	Variable position
Engine cooling	Air	Transmission type	Hydrostatic trans-axle
Axle front/rear, in (mm)	3/4 (19)	Transmission speeds, fpm	0-80
Wheels front, in (mm)	5 x 1.5 x 3/4 (127 x 38 x 19)		
Wheels rear, in (mm)	10 x 3 x 7/8 (254 x 76 x 22)		

\*As rated by the engine manufacturer.

RECOMMENDED DIAMOND TOOLS

VARI-CUT™ PLUS

# Husqvarna FS 400

## Applications

- Perfect for smaller jobs such as sidewalks, driveways and city streets.
- A great rental saw.

## Benefits

- Productive push saw with excellent weight distribution and stability, which enhances maneuverability.
- Adjustable, low-vibration handlebar increases operator comfort.
- Patented gas-assisted raise/lower system reduces force required to raise and lower the blade in and out of the cut.
- It is easy to transport and lift due to its small size and weight.
- Optimum power transmission to the blade due to the Poly V-belt, which increases production.
- Large integrated water tank is standard.



FS Models	FS 400
Part No.	967796502

## Technical Specifications

Maximum blade diameter, in (mm)	20 (508)
Maximum depth of cut, in (mm)	7-5/8 (193)
Average bladeshaft, rpm	2,800
Blade flanges, in (mm)	4.5 (114)
Maximum weight crated, lbs (kg)	287 (130)
Maximum weight uncrated, lbs (kg)	219 (99)

Power source	Honda GX390	Blade guard type	Bolt On
Maximum power, hp (kW)*	11 (8)	Number of belts	12 rib poly v belt
Arbor size, in (mm)	1 (25)	Blade depth control	Spring assist screw feed
Bladeshaft diameter, in (mm)	1-3/16 (21.5)	Dimensions uncrated, pointer and blade guard up, handles, in (mm) L x W x H	42 x 20 x 30 (1,067 x 508 x 991)
Cylinders/cycle	1/4	Displacement, cu in (l)	23.7 (389) 3.7
Fuel capacity, gal (l)	1.6 (6.1)	Bore/stroke, in (mm)	3.5 (88)/2.5 (64)
Air filter	Dry type dual dual element cyclone	Oil capacity, qt (l)	1.2 (1.3)
Starter	Recoil	Handlebar adjustment	Multiple position
Engine cooling	Air	Transmission type	Push
Axle front/rear, in (mm)	3/4 (19)	Transmission speeds, fpm	0-80
Wheels front, in (mm)	5 x 1.5 x 5/8 (125 x 38 x 16)		
Wheels rear, in (mm)	8 x 1.5 x 5/8 (203 x 38 x 16)		

\*As rated by the engine manufacturer.

**RECOMMENDED DIAMOND TOOLS**

**VARI-CUT™ PLUS**



# Husqvarna FS 309

## Applications

- Ideal for cutting in difficult to access job sites.
- Utilized for very small road repair jobs.
- It is perfect for residential jobs.
- Left-hand sawing only.

## Benefits

- Very lightweight and compact, it eases transporting and handling of the saw.
- Adjustable handle and extendable rear wheel increases stability and reduces fatigue.
- Gas assisted raise/lower system reduces the force required to raise and lower the blade in and out of the cut.
- Excellent power transmission to the blade due to the Poly V-belt, which increases production.



<b>FS Models</b>	<b>FS 309</b>
Part No.	967678301

## Technical Specifications

Maximum blade diameter, in (mm)	14 (350)
Maximum depth of cut, in (mm)	4-5/8 (117)
Average bladeshaft, rpm	3,500
Blade flanges, in (mm)	4.5 (114)
Maximum weight crated, lbs (kg)	198 (90)
Maximum weight uncrated, lbs (kg)	117 (53)

Power source	Honda	Wheels rear, in (mm)	6 x 1.5x 5/8 (152 x 38 x 16)
Maximum power, hp (kW)*	8-1/2 (6)	Blade guard type	Bolt On
Power at bladeshaft, hp (kW)	N/A	Number of belts	14 rib poly V
Arbor size, in (mm)	1 (25)	Blade depth control	Screw feed
Bladeshaft diameter, in (mm)	3/4 (19)	Dimensions uncrated, pointer and blade guard up, handles, in (mm) L x W x H	36 x 15 x 39 (915 x 381 x 990)
Cylinders/cycle	1/4	Displacement, cu in (l)	16.2 (265)
Fuel capacity, gal (l)	1.6 (6.1)	Bore/stroke, in (mm)	2.95 (75)/2.36 (60)
Air filter	Dry type dual element cyclone	Oil capacity, qt (l)	1.2 (1.1)
Starter	Recoil	Handlebar adjustment	Variable Position
Engine cooling	Air	Transmission type	Push
Axle front/rear, in (mm)	-		
Wheels front, in (mm)	4 x 1.5 x 5/8 (114 x 38 x 16)		

\*As rated by the engine manufacturer.

**RECOMMENDED DIAMOND TOOLS**

**VARI-CUT™ PLUS**

# FS 7000 DL & FS 7000 D Accessories & Spare Parts

Accessories	FS 7000 DL		FS 7000 D	
	3-SP	1-SP	3-SP	1-SP
Blade clutch kit	586701501	X	X	X
Blade guard slip-on, 14"	586343101		X	X
Blade guard slip-on, 20"	586343201		X	X
Blade guard slip-on, 26"	586343301		X	X
Blade guard slip-on, 30"	586343401		X	X
Blade guard slip-on, 36"	586343501	X	X	X
Blade guard slip-on, 42"	586009901	X	X	
Blade guard bolt-on, 48"	582553501	X	X	
Blade guard bolt-on, 60"	582537401	X	X	
Blade guard slip-on with mount kit, 42"	586009901		X	X
Dual light kit, LED	585924601	X	X	X
Water pump kit	586012301	X	X	X
Weight kit, 35 lbs	581678901	X	X	X
Weight kit, 70 lbs	581678902	X	X	X
Wrench, bladeshaft	504626403	X	X	X
5th wheel kit, field installed	582307901	X	X	X
Spare Parts	3-SP	1-SP	3-SP	1-SP
Blade collar (outer flange with drive pin), 5"	522965937	X	X	X
Blade collar (outer flange with drive pin), 6"	522965939	X	X	X
Blade collar (outer flange with drive pin), 7"	522965938	X	X	X
Blade collar (outer flange with drive pins), 8"	522965940	X	X	
Blade collar (outer flange with drive pin), 10" & Rogers BHP	522965941	X	X	
Bladeshaft belt, 20"x4, 36"x4	585514901		X	X
Bladeshaft belt, 26"x4, 30"x4	542166362		X	X
Bladeshaft belt, 42"x4	542199764		X	X
Bladeshaft belt, 26"x4	504119706		X	X
Bladeshaft belt, 30"x4	504119707		X	X
Bladeshaft belt, 36" x 4	541200847		X	X
Bladeshaft belt, 42" x 4	504119701		X	X
Bladeshaft belt, 48" 1-speed	542199699			X
Bladeshaft belt, 60" 1-speed	504119701			X
Bladeshaft belt, 36" 3-speed	504119701	X	X	
Bladeshaft belt, 42" 3-speed	541200991	X		
Bladeshaft belt, 48" 3-speed	504119701	X	X	
Bladeshaft belt, 60" 3-speed	541200807	X		
Bladeshaft bolt LH 14" - 36"	586255901	X	X	X
Bladeshaft bolt LH 42"	586256101	X	X	X
Bladeshaft bolt RH 14" - 36"	586255701	X	X	X
Bladeshaft bolt RH 42"	586256001	X	X	X
Drive pin, 18" - 30"	505531901		X	X
Drive pin, 36"-60"	539300010	X	X	X
Filter, air inner	542191116	X	X	X
Filter, air outer	542191115	X	X	X
Filter, Duetz engine fuel	581777101	X	X	X
Filter, Duetz engine oil	586010801	X	X	X
Filter, hydraulic oil	542166449	X	X	X
Water separator, Duetz	581776901	X	X	X
Wheel, front	590649901	X	X	X
Wheel, rear	542198842	X	X	X

# FS 5000 D & FS 3500 G/E Accessories & Spare Parts

Accessories		FS 5000 D		FS 3500	
		3-SP	1-SP	Gas	Electric
Blade clutch kit	586701401	X	X		
Blade guard slip-on, 14"	586343101	X	X		
Blade guard slip-on, 18"	542198778			X	X
Blade guard slip-on, 20"	586343201	X	X		
Blade guard slip-on, 20"	504857701			X	X
Blade guard slip-on, 26"	586343301	X	X		
Blade guard slip-on, 26"	542203266			X	X
Blade guard slip-on, 30"	586343401	X	X		
Blade guard slip-on, 30"	542203305			X	X
Blade guard slip-on, 36"	586343501	X	X		
Dual light kit, LED	585924601	X	X		
Light kit, field installed	592917601			X	
Parking brake kit, field installed	592917201			X	
Parking brake kit, field installed	579804901				X
Water pump kit	586012301	X	X		
Water pump kit, field installed	592916701			X	
Water safety switch, field installed	592916801			X	
Wrench, blade	504626403	X	X	X	
5th wheel kit, field installed	582307801	X	X		
Spare Parts		3-SP	1-SP	Gas	Electric
Blade collar (outer flange with drive pin), 4.5"	586009201	X	X	X	
Blade collar (outer flange with drive pin), 5"	586009301	X	X		
Blade collar (outer flange with drive pin), 6"	586009401	X	X		
Bladeshaft belt, 14" x 4	576449151		X		
Bladeshaft belt, 20"	582716001			X	
Bladeshaft belt, 20" x 4 or 30" x 4	505777401		X	X	
Bladeshaft belt, 26" 30"	582623301			X	
Bladeshaft belt, 26" x 4	576449150		X	X	
Bladeshaft belt, 36" x 4	581294101		X	X	
Bladeshaft belt, 26"x4; 30"x4	585515001	X			
Bladeshaft belt, 36" x 4	541201391	X			
Bladeshaft bolt LH 14" - 36"	586255901	X	X	X	
Bladeshaft bolt RH 14" - 36"	586255701	X	X	X	
Drive pin, 18" - 30"	505531901	X	X	X	
Drive pin, 36"-60"	539300010	X	X		
Filter, air inner	542166454	X	X		
Filter, air outer	542166453	X	X		
Filter, engine oil	505797401			X	
Filter, primary air	505798001			X	
Filter, safety air	505798101			X	
Filter, Yanmar engine oil	542206369	X	X		
Filter, Yanmar fuel	593175401	X	X		
Water separator filter element, Yanmar	587689801	X	X		
Wheel, front	590649801	X	X	X	
Wheel, rear	542198842	X	X		
Wheel, rear	542045090			X	



# FS 500 Series, FS 413/400 & FS 309 Accessories & Spare Parts

Accessories		FS 513	FS 520	FS 524	FS 413	FS 400	FS 309
Blade guard, 14"	579801001						X
Blade guard, 18" (1-piece only)	502082901					X	
Blade guard complete, 20"	501125901	X	X	X	X		
Blade guard, 20"	593586201					X	
Blade guard, 24"	542204187		X	X			
Guide, front cutting	504069201					X	
Water tank (7.9 gal)	599266701					X	
Water tank kit (6.6 gal)	541208286	X	X	X	X		
Water tank kit complete	543084137						X
Wrench, bladeshaft	543045904					X	X
Wrench, bladeshaft	542202292	X	X	X	X		
Wrench, 13mm	543045891						X
Spare Parts		FS 513	FS 520	FS 524	FS 413	FS 400	FS 309
Bearing, bladeshaft	543045052					X	
Belt, hydrostatic drive	505246201	X	X	X			
Belt, hydrostatic transition drive	510237201	X	X	X			
Blade collar, outer 20"	542167962	X	X	X	X		
Bladeshaft belt	542202150	X			X		
Bladeshaft belt	588768501					X	
Bladeshaft belt (prior to FS 520 s/n 2150)	542202149		X				
Bladeshaft belt (prior to FS 524 s/n 2150)	504068301			X			
Bolt for flanges	543077344					X	
Bolt for flanges	725253471						X
Drive pin	542167964	X	X	X	X		
Element, canister air cleaner	577998701		X	X			
Flange, inner	504068801					X	
Flange, inner	502498601						X
Flange, outer	504707001					X	X
Poly V-belt	588768401						X
Pulley, bladeshaft	543083268						X
Pulley, bladeshaft	543046571					X	
Water injectors, blade guard	543081271						X
Wheel, front	543045949	X	X	X	X	X	
Wheel, front	543045948						X
Wheel, rear	543045951				X	X	
Wheel, rear	586442801	X	X	X			
Wheel, rear	543045950						X



# Diamond Blades for Flat Sawing

FLAT SAWS

## 70+ HP APPLICATION CHART

CATAGORY	CURED CONCRETE			ASPHALT OVERLAY			GREEN CONCRETE			ASPHALT		
	Hard	Medium	Soft	Hard	Medium	Soft	Hard	Medium	Soft	Hard	Medium	Soft
<b>BEST</b>		F920C	F927C				F1150G	F1155G	F1165G			
<b>BETTER</b>	F910C	F720C		F7500	F7550		F955G	F965G		F770A	F780A	F785A
<b>GOOD</b>	F710C						F751G	F765G	F781G			

## 50-90 HP APPLICATION CHART

CATAGORY	CURED CONCRETE			ASPHALT OVERLAY			GREEN CONCRETE			ASPHALT		
	Hard	Medium	Soft	Hard	Medium	Soft	Hard	Medium	Soft	Hard	Medium	Soft
<b>BEST</b>	F910C	F920C	F927C	F7500		F7550	F1150G	F1155G	F1165G	F770A	F780A	F785A
<b>BETTER</b>	F710C	F720C		F6500			F955G	F965G		F680A		
<b>GOOD</b>	F610	F620C					F751G	F765G	F781G			

## 35-50 HP APPLICATION CHART

CATAGORY	CURED CONCRETE			ASPHALT OVERLAY			GREEN CONCRETE			ASPHALT		
	Hard	Medium	Soft	Hard	Medium	Soft	Hard	Medium	Soft	Hard	Medium	Soft
<b>BEST</b>	F610C	F620C	F620C	F6500			F751G			F680A		
<b>BETTER</b>	150B	200B	200B	450B			450B			500B		
<b>GOOD</b>	HIGH PRO CURED / FLX 230			HIGH PRO AOL / FLX280			FLX280			HIGH PRO AOL / FLX280		

### "LOU" Arbor Configuration

Blades 20" and above

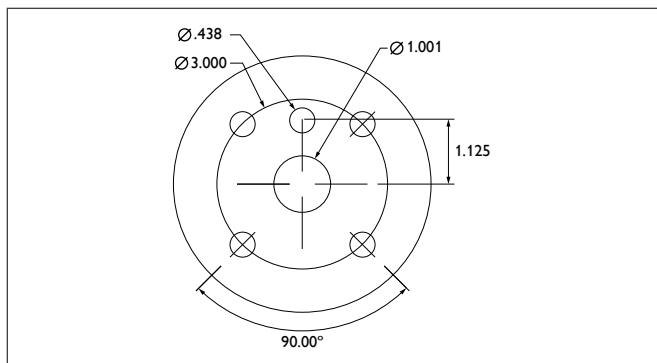

### "Roger" Arbor Configuration

Blades 54" and above

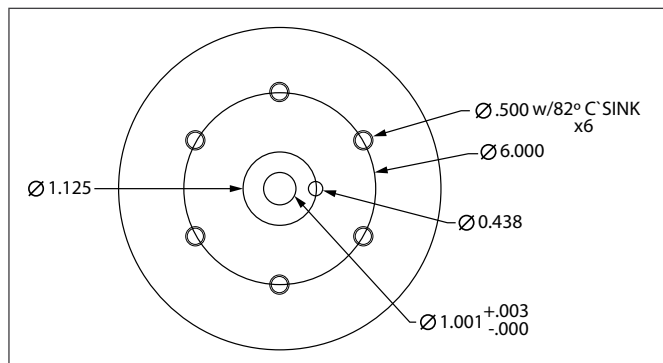



# Flat Saw Diamond Blade Stock Chart

The chart below shows which of our diamond tools are stock items for particular sizes and which are built when ordered. Note the F940C, F7550, F765G, F785A, F630C and F6500 are only built when ordered, not stock items.

	F1510Z	F1520Z	F1530C	F1150G	F1155G	F1165G	F910C	F915C	F917C	F920C	F925C	F927C	F930C	F955G	F965G	F710C	F720C	F7500	F751G	F781G	F770A	F780A	F605C	F610C	F620C	F680A	150B	200B	450B	500B	Banner Line	
14 x .110																																
14 x .125				■	■	■				■					■				■						■				■	■	■	
14 x .140				■	■								■																			
14 x .187					■							■								■												
14 x .220					■																											
14 x .250					■							■	■	■																		
16 x .125																									■				■			
16 x .140					■					■					■																	
18 x .125										■																						
18 x .140										■							■								■							
18 x .155										■		■																				
18 x .165										■																						
18 x .187										■																						
20 x .125						■	■																		■				■	■	■	■
20 x .140										■																						
20 x .155													■																			
20 x .165										■			■														■					
20 x .187										■	■																					
24 x .125																																
24 x .155										■		■																				
24 x .165										■		■												■	■	■	■	■	■	■	■	■
24 x .187										■																						
26 x .155										■		■																				
26 x .165										■		■					■	■	■					■			■	■	■	■	■	■
26 x .175										■																						
26 x .187										■		■	■											■	■							
30 x .165										■		■													■	■				■	■	
30 x .187										■		■	■					■							■					■	■	
36 x .165										■		■													■					■	■	
36 x .187										■		■						■														
36 x .220										■																						
42 x .187										■																						
42 x .220										■																						
48 x .187										■																						
48 x .220										■																						
60 x .220										■																						

■ = STOCK ITEM

# Diamond Blades for Flat Sawing

## Professional® F1500C Series CURED CONCRETE BLADES

- F1510Z: 50-84 HP saws, .630" Z-EDGE segment, fast cutting in reinforced concrete with medium to hard aggregate.
- F1520Z: 50-84 HP saws, .610" Z-EDGE/straight segment, fast cutting with extended life in reinforced concrete with medium to hard aggregate.
- F1530C: 60+ HP saws, .550" standard segment, fast cutting and extended segment life in reinforced concrete with soft to medium hard aggregate.

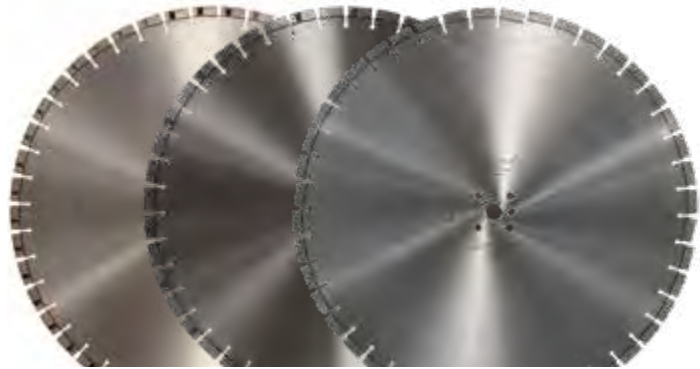

### F1500 Series

Sizes - Inches (mm)	F1510Z Part Number	F1520Z Part Number	F1530C Part Number
18 (457) x .165 x 1 DP - Narrow Notch	597147901	597479801	-
18 (457) x .187 x 1 DP - Narrow Notch	597298401	597930401	-
20 (508) x .165 x 1 DP LOU - Narrow Notch	596819601	597506901	-
20 (508) x .187 x 1 DP LOU - Narrow Notch	596827801	597338901	-
24 (600) x .165 x 1 DP LOU - Narrow Notch	597200801	597479901	-
24 (600) x .187 x 1 DP LOU - Narrow Notch	596140501	597930402	-
26 (660) x .165 x 1 DP LOU - Narrow Notch	596819602	597596601	-
26 (660) x .187 x 1 DP LOU - Narrow Notch	595869702	597212601	-
28 (711) x .165 x 1 DP LOU - Narrow Notch	597298402	597930403	-
28 (711) x .187 x 1 DP LOU - Narrow Notch	596907501	597478601	-
30 (762) x .165 x 1 DP LOU - Narrow Notch	597298403	597616501	-
30 (762) x .187 x 1 DP LOU - Narrow Notch	595952701	597338902	-
36 (914) x .165 x 1 DP LOU - Narrow Notch	597298404	597724201	-
36 (914) x .187 x 1 DP LOU - Narrow Notch	596783201	597724202	-
42 (1067) x .187 x 1 DP LOU - Narrow Notch	596999701	597930404	-
48 (1219) x .187 x 1 DP LOU/ROG - Wide Notch	597298405	597930405	-
18 (457) x .165 x 1 DP - Recess Protection	-	-	597936501
18 (457) x .187 x 1 DP - Recess Protection	-	-	597936502
20 (508) x .155 x 1 DP LOU - Recess Protection	-	-	597936519
20 (508) x .165 x 1 DP LOU - Recess Protection	-	-	597936503
20 (508) x .187 x 1 DP LOU - Recess Protection	-	-	597936504
24 (600) x .165 x 1 DP LOU - Recess Protection	-	-	597936505
24 (600) x .187 x 1 DP LOU - Recess Protection	-	-	597936506
26 (660) x .155 x 1 DP LOU - Recess Protection	-	-	597936520
26 (660) x .165 x 1 DP LOU - Recess Protection	-	-	597936507
26 (660) x .187 x 1 DP LOU - Recess Protection	-	-	597936508
28 (711) x .165 x 1 DP LOU - Recess Protection	-	-	597936509
28 (711) x .187 x 1 DP LOU - Recess Protection	-	-	597503602
30 (762) x .165 x 1 DP LOU - Recess Protection	-	-	597936510
30 (762) x .187 x 1 DP LOU - Recess Protection	-	-	597936511
36 (914) x .165 x 1 DP LOU - Recess Protection	-	-	597936512
36 (914) x .187 x 1 DP LOU - Recess Protection	-	-	597936513
42 (1067) x .187 x 1 DP LOU - Recess Protection	-	-	598476001
48 (1219) x .187 LOU/ROG - Recess Protection	-	-	598476101
26 (660) x .187 x 1 DP LOU - No Recess Protection	-	-	597936516
28 (711) x .187 x 1 DP LOU - No Recess Protection	-	-	597503601
30 (762) x .187 x 1 DP LOU - No Recess Protection	-	-	597936517
36 (914) x .187 x 1 DP LOU - No Recess Protection	-	-	597936518

# Diamond Blades for Flat Sawing

## Professional® F1100G Series GREEN CONCRETE BLADES

- F1150G: 50-74 HP, green concrete with flint or quartz aggregate
- F1155G: 50-74 HP, green concrete with granite, basalt or river gravel aggregate
- F1165G: 50-74 HP, green concrete with limestone aggregate

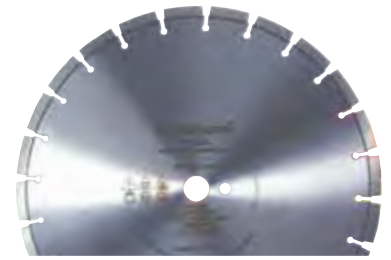

FLAT SAWS

### F1100G Series | Wet Cutting | Laser Welded

Sizes - Inches (mm)	F1150G Part Number	F1155G Part Number	F1165G Part Number
14 (350) x .125 x 1 DP - Narrow Notch	598777401	597610201	598656101
14 (350) x .140 x 1 DP - Narrow Notch	598777402	597610202	598656102
14 (350) x .155 x 1 DP - Narrow Notch	598777403	597610203	598656103
14 (350) x .187 x 1 DP - Narrow Notch	598777404	597610204	598656104
14 (350) x .220 x 1 DP - Narrow Notch	598777405	597610205	598656105
14 (350) x .250 x 1 DP - Narrow Notch	598777406	597610206	598656106
16 (400) x .125 x 1 DP - Narrow Notch	598777407	597610207	598656107
16 (400) x .140 x 1 DP - Narrow Notch	598777408	597610208	598656108
18 (457) x .125 x 1 DP - Narrow Notch	598777409	597610209	598656109
18 (457) x .140 x 1 DP - Narrow Notch	598777410	597610210	598656110

.125"- .187" width blades: total segment height is .570" (.450" diamond depth, .120" segment base) | .220" & above width blades: total segment height is .500" (.380" diamond depth, .120" segment base) | All blades have vertical insert undercut protection.



# Diamond Blades for Flat Sawing

## Professional® F900C Series CURED CONCRETE BLADES

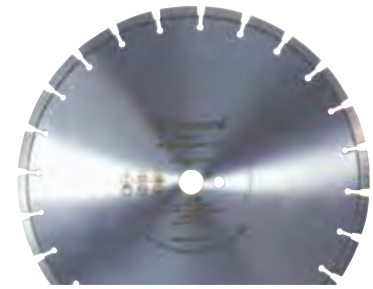

- F910C: 50-75 HP, hard river rock aggregate and bridge deck with heavy steel reinforcement
- F917C: 50-99 HP, hard river rock aggregate with medium steel reinforcement
- F920C: 50-95 HP, medium hard aggregate with medium steel reinforcement
- F925C: 50-95 HP, long life in medium to hard aggregate with medium steel reinforcement
- F927C: 50-110 HP, fast cutting speed in medium reinforced concrete with medium aggregate

### F900C Series | Wet Cutting | Laser Welded

Sizes - Inches (mm)	F910C Part No.	F917C Part No.	F920C Part No.	F925C Part No.	F927C Part No.
14 (350) x .125 x 1 DP - Narrow Notch	542758226	-	542758246	-	542750700
14 (350) x .140 x 1 DP - Narrow Notch	542758227	-	542758247	-	542750701
14 (350) x .165 x 1 DP - Narrow Notch	542758228	-	542758248	-	542750702
14 (350) x .187 x 1 DP - Narrow Notch	542758229	-	542758249	-	542750703
14 (350) x .250 x 1 DP - Narrow Notch	585699001	-	542766902	-	542766526
16 (400) x .125 x 1 DP - Narrow Notch	542758230	-	542758250	-	542750704
16 (400) x .140 x 1 DP - Narrow Notch	542758231	-	542758251	-	542750705
18 (457) x .125 x 1 DP - Narrow Notch	542758232	542751733	542758252	542758272	542750706
18 (457) x .140 x 1 DP - Narrow Notch	542758233	587094801	542758253	542758273	542750707
18 (457) x .155 x 1 DP - Narrow Notch	542758234	542751734	542758254	542758274	542750708
18 (457) x .165 x 1 DP - Narrow Notch	542758235	542751735	542758255	542758275	542750709
18 (457) x .187 x 1 DP - Narrow Notch	542766430	542767337	542766386	593071701	542766810
18 (457) x .250 x 1 DP - Narrow Notch	593071301	593071503	593071601	593071702	593071801
20 (508) x .125 x 1 DP LOU - Narrow Notch	542758236	542751736	542758256	542758276	542750710
20 (508) x .140 x 1 DP LOU - Narrow Notch	542766751	585176901	542766375	542766740	585579201
20 (508) x .155 x 1 DP LOU - Narrow Notch	586920601	542767254	587215501	542758277	591469501
20 (508) x .165 x 1 DP LOU - Narrow Notch	542758238	593000201	542758258	587276701	590057102
20 (508) x .187 x 1 DP LOU - Narrow Notch	542758239	542751737	542758259	542758279	542750713
24 (600) x .155 x 1 DP LOU - Narrow Notch	586920501	593071504	593071602	593071703	591172701
24 (600) x .165 x 1 DP LOU - Narrow Notch	542758241	542751739	542758261	542758281	591188401
24 (600) x .187 x 1 DP LOU - Narrow Notch	593071303	593071505	542766743	593071704	589817701
24 (600) x .220 x 1 DP LOU - Narrow Notch	593071302	593071506	593071603	593071705	593071803
26 (660) x .155 x 1 DP LOU - Narrow Notch	588926201	542751741	542758263	542758283	542750717
26 (660) x .165 x 1 DP LOU - Narrow Notch	542766673	542757019	542758264	542758284	542750718
26 (600) x .175 x 1 DP LOU - Narrow Notch	-	-	579778601	501665502	593071804
26 (660) x .187 x 1 DP LOU - Narrow Notch	586686402	542751742	542758265	542758285	542750719
26 (660) x .220 x 1 DP LOU - Narrow Notch	588833401	584610201	593071604	590153101	542773960
28 (711) x .165 x 1 DP LOU - Narrow Notch	585800501	587522201	542766544	542766607	542766355
28 (711) x .175 x 1 DP LOU - Narrow Notch	-	-	501669602	579680101	-
28 (711) x .187 x 1 DP LOU - Narrow Notch	542766763	542767247	542773371	542773372	585497201
30 (762) x .165 x 1 DP LOU - Narrow Notch	542773870	584994801	542773652	593071706	542750720
30 (762) x .175 x 1 DP LOU - Narrow Notch	579694701	-	501888501	501876101	501136202
30 (762) x .187 x 1 DP LOU - Narrow Notch	585259002	587047602	542776387	542773700	542773868
30 (762) x .220 x 1 DP LOU - Narrow Notch	542767113	584610301	593071605	593071707	593071805
36 (914) x .165 x 1 DP LOU - Narrow Notch	585701501	584994401	542755192	542766968	542773866
36 (914) x .175 x 1 DP LOU - Narrow Notch	593071304	592999001	593071606	593071708	593071806
36 (914) x .187 x 1 DP LOU - Narrow Notch	587047401	584477703	542766316	593071709	542773869
36 (914) x .220 x 1 DP LOU - Narrow Notch	593071305	593071508	593071607	586644201	542766845

Blade < 20": no undercut protection | Blades > 24": undercut production (recessed segment)

# Diamond Blades for Flat Sawing

## Professional® F900C Deep Saw Series CURED CONCRETE BLADES

- F920C 22": 50-110 HP, medium hard aggregate with medium steel reinforcement
- F920C 30": 50-110 HP, medium hard aggregate with medium steel reinforcement



### F900C Deep Saw Series | Wet Cutting | Laser Welded | Brazed

Sizes - Inches (mm)	F920C 22" Part Number	F920C 30" Part Number
18 (450) x .220 x 1 DP - Narrow Notch	542766315	-
18 (450) x .250 x 1 DP - Narrow Notch	-	593071601
26 (660) x .187 x 1 DP LOU - Narrow Notch	542758265	-
26 (660) x .220 x 1 DP LOU - Narrow Notch	-	598693202
30 (762) x .187 x 1 DP LOU - Narrow Notch	542776387	-
30 (762) x .220 x 1 DP LOU - Narrow Notch	-	598831403
36 (914) x .187 x 1 DP LOU - Narrow Notch	542766316	-
36 (914) x .220 x 1 DP LOU - Narrow Notch	-	593071607
42 (1067) x .187 x 1 DP LOU - Wide Notch	593071608	-
42 (1067) x .220 x 1 DP LOU - Wide Notch	-	593071609
48 (1219) x .187 x 1 DP LOU/ROG - Wide Notch	593071610	-
48 (1219) x .220 x 1 DP LOU/ROG - Wide Notch	-	593071611
54 (1271) x .187 x 1 DP LOU/ROG - Wide Notch	593071617	-
54 (1271) x .220 x 1 DP LOU/ROG - Wide Notch	-	593071612
60 (1523) x .220 x 1 DP LOU/ROG - Wide Notch	-	593071613
72 (1828) x .220 x 1 DP LOU/ROG - Wide Notch	-	598831405

125"-187" width blades: total segment height is .570" (.450" diamond depth, .120" segment base) | 220" & above width blades: total segment height is .500" (.380" diamond depth, .120" segment base) | Blades 54" and larger are brazed.

## Professional® F900G Series GREEN CONCRETE BLADES

- F955G: 50-74 HP, green concrete with granite or flint aggregate
- F965G: 50-74 HP, green concrete with limestone aggregate
- All blades have vertical inserts.



### F900G Series | Wet Cutting | Laser Welded

Sizes - Inches (mm)	F955G Part Number	F965G Part Number
14 (350) x .125 x 1 DP - Narrow Notch	598812701	598812901
14 (350) x .140 x 1 DP - Narrow Notch	598812702	598812902
14 (350) x .155 x 1 DP - Narrow Notch	598812703	598812903
14 (350) x .187 x 1 DP - Narrow Notch	598812704	598812904
14 (350) x .220 x 1 DP - Narrow Notch	598812705	598812905
14 (350) x .250 x 1 DP - Narrow Notch	598812706	598812906
16 (400) x .125 x 1 DP - Narrow Notch	598812707	598812907
16 (400) x .140 x 1 DP - Narrow Notch	598812708	598812908
18 (450) x .125 x 1 DP - Narrow Notch	598812709	598812909
18 (450) x .140 x 1 DP - Narrow Notch	598812710	598812910

125"-187" width blades: total segment height is .570" (.450" diamond depth, .120" segment base) | 220" & above width blades: total segment height is .500" (.380" diamond depth, .120" segment base) | Blades 54" and larger are brazed.

# Diamond Blades for Flat Sawing

## Professional® F700C Series CURED CONCRETE BLADES

- F710C: 50-70 HP, hard river rock aggregate with heavy steel reinforcement
- F720C: 50-70 HP, medium to soft granite and limestone aggregate with medium steel reinforcement



### F700C Series | Wet Cutting | Laser Welded

Sizes - Inches (mm)	F710C Part Number	F720C Part Number
14 (350) x .125 x 1 DP - Narrow Notch	592879501	592879601
14 (350) x .140 x 1 DP - Narrow Notch	592879502	592879602
14 (350) x .165 x 1 DP - Narrow Notch	592879503	592879603
14 (350) x .187 x 1 DP - Narrow Notch	592879504	592879604
14 (350) x .250 x 1 DP - Narrow Notch	592879505	592879605
16 (400) x .125 x 1 DP - Narrow Notch	592879506	592879606
16 (400) x .140 x 1 DP - Narrow Notch	592879507	592879607
18 (457) x .125 x 1 DP - Narrow Notch	592879508	592879608
18 (457) x .140 x 1 DP - Narrow Notch	592879509	592879609
18 (457) x .165 x 1 DP - Narrow Notch	592879511	592879611
18 (457) x .187 x 1 DP - Narrow Notch	592879512	592879612
18 (457) x .250 x 1 DP - Narrow Notch	592879513	592879613
20 (508) x .125 x 1 DP LOU - Narrow Notch	592879514	592879614
20 (508) x .140 x 1 DP LOU - Narrow Notch	592879515	592879615
20 (508) x .165 x 1 DP LOU - Narrow Notch	592879516	592879616
24 (600) x .165 x 1 DP LOU - Narrow Notch	592879518	592879618
24 (600) x .187 x 1 DP LOU - Narrow Notch	592879519	592879619
24 (600) x .220 x 1 DP LOU - Narrow Notch	592879520	592879620
26 (660) x .165 x 1 DP LOU - Narrow Notch	592879522	592879622
26 (660) x .187 x 1 DP LOU - Narrow Notch	592879523	592879623
26 (660) x .220 x 1 DP LOU - Narrow Notch	592879524	592879624
30 (762) x .165 x 1 DP LOU - Narrow Notch	592879525	592879625
30 (762) x .187 x 1 DP LOU - Narrow Notch	592879526	592879626
30 (762) x .220 x 1 DP LOU - Narrow Notch	592879527	592879627
36 (914) x .165 x 1 DP LOU - Narrow Notch	592879528	592879628
36 (914) x .187 x 1 DP LOU - Narrow Notch	592879529	592879629
36 (914) x .220 x 1 DP LOU - Narrow Notch	592879530	592879630

Blade < 20": no undercut protection | Blades > 24": undercut production (recessed segment)



# Diamond Blades for Flat Sawing

## Professional® F700G Series GREEN CONCRETE BLADES

- F751G: 35-74 HP, green concrete with flint or quartz aggregate
- F765G: 35-74 HP, green concrete with granite, basalt or river gravel aggregate
- F781G: 35-74 HP, green concrete with limestone aggregate
- All blades have deep square segments



FLAT SAWS

### F700G Series | Wet Cutting | Laser Welded | Brazed

Sizes - Inches (mm)	F751G Part Number	F765G Part Number	F781G (Brazed) Part Number
14 (350) x .125 x 1 DP	596751801	597152501	597152401
14 (350) x .140 x 1 DP	596751802	597152502	597152402
14 (350) x .155 x 1 DP	596751803	597152503	597152403
14 (350) x .187 x 1 DP	596751804	597152504	597152404
14 (350) x .220 x 1 DP	596751805	597152505	597152405
14 (350) x .250 x 1 DP	596751806	597152506	597152406
16 (400) x .125 x 1 DP	596751807	597152507	597152407
16 (400) x .140 x 1 DP	596751808	597152508	597152408
18 (457) x .125 x 1 DP	596751809	597152509	597152409
18 (457) x .140 x 1 DP	596751810	597152510	597152410

125"-.187" width blades: total segment height is .570" (.450" diamond depth, .120" segment base) | .220" & above width blades: total segment height is .500" (.380" diamond depth, .120" segment base)

# Diamond Blades for Flat Sawing

## Professional® F7000 Series ASPHALT OVERLAY BLADES

- F7500: 50-110 HP, asphalt over medium to hard concrete with river gravel aggregate
- F7550: 50-110 HP, asphalt over medium to soft concrete with granite or limestone aggregate
- All blades have recessed segments



### F7000 Series | Wet Cutting | Laser Welded

Sizes - Inches (mm)	F7500 Part Number	F7550 Part Number
14 (350) x .125 x 1 DP - Narrow Notch	597157701	597158501
14 (350) x .187 x 1 DP - Narrow Notch	597157702	597158502
14 (350) x .250 x 1 DP - Narrow Notch	597157703	597158503
18 (457) x .125 x 1 DP - Narrow Notch	597157704	597158504
18 (457) x .165 x 1 DP - Narrow Notch	597157706	597158505
18 (457) x .187 x 1 DP - Narrow Notch	597157707	597158506
18 (457) x .250 x 1 DP - Narrow Notch	597157708	597158507
24 (600) x .165 x 1 DP LOU - Narrow Notch	542758853	542759526
24 (600) x .187 x 1 DP LOU - Narrow Notch	542758854	542759527
26 (660) x .165 x 1 DP LOU - Narrow Notch	590925401	542759530
26 (660) x .187 x 1 DP LOU - Narrow Notch	587204301	542759531
26 (660) x .250 x 1 DP LOU - Narrow Notch	542759563	542759533
30 (762) x .165 x 1 DP LOU - Narrow Notch	542758861	542759535
30 (762) x .187 x 1 DP LOU - Narrow Notch	542758862	542759536
30 (762) x .250 x 1 DP LOU - Narrow Notch	542759564	542759538
36 (914) x .165 x 1 DP LOU - Narrow Notch	590571901	542759539
36 (914) x .187 x 1 DP LOU - Narrow Notch	542758865	542759540
36 (914) x .250 x 1 DP LOU - Narrow Notch	542759542	542759542
26 (660) x .165 x 1 DP LOU - Wide Notch	542758867	586027502
26 (660) x .187 x 1 DP LOU - Wide Notch	542758868	542759544
30 (762) x .165 x 1 DP LOU - Wide Notch	542758869	542759546
30 (762) x .187 x 1 DP LOU - Wide Notch	542758870	542759547
30 (762) x .250 x 1 DP LOU - Wide Notch	542759567	542759548
36 (914) x .187 x 1 DP LOU - Wide Notch	542758871	542759549
36 (914) x .250 x 1 DP LOU - Wide Notch	542759550	542759550

125"-187" width blades: total segment height is .570" (.450" diamond depth; .120" segment base) | 220" & above width blades: total segment height is .500" (.380" diamond depth; .120" segment base)

# Diamond Blades for Flat Sawing

## Professional® F700A Series ASPHALT BLADES

- F770A: 50-110 HP, asphalt with non-abrasive aggregates or non-abrasive sand
- F780A: 50-110 HP, general purpose asphalt cutting
- F785A: 50-110 HP, asphalt with soft aggregates or very abrasive sand
- All blades have recessed segments



### F700A Series | Wet Cutting | Laser Welded

Sizes - Inches (mm)	F770A Part Number	F780A Part Number	F785A Part Number
14 (350) x .125 x 1 DP - Narrow Notch	597158601	597158701	542759385
14 (350) x .140 x 1 DP - Narrow Notch	597158602	597158702	597158802
14 (350) x .187 x 1 DP - Narrow Notch	597158603	597158703	597158803
14 (350) x .250 x 1 DP - Narrow Notch	597158604	597158704	597158804
18 (457) x .125 x 1 DP - Narrow Notch	597158605	597158705	597158805
18 (457) x .140 x 1 DP - Narrow Notch	597158606	597158706	-
18 (457) x .165 x 1 DP - Narrow Notch	597158607	597158707	597158807
18 (457) x .187 x 1 DP - Narrow Notch	597158608	597158708	597158808
20 (508) x .140 x 1 DP LOU - Narrow Notch	542759328	591396901	-
20 (508) x .165 x 1 DP LOU - Narrow Notch	542759569	591469601	542759571
24 (600) x .165 x 1 DP LOU - Narrow Notch	501165002	591188301	542759397
24 (600) x .187 x 1 DP LOU - Narrow Notch	542759330	542759364	542759398
26 (660) x .165 x 1 DP LOU - Narrow Notch	590925601	542759365	542759399
26 (660) x .187 x 1 DP LOU - Narrow Notch	542759332	542759366	542759400
14 (350) x .125 x 1 DP - Wide Notch	542759336	542759370	-
14 (350) x .140 x 1 DP - Wide Notch	542759337	542759371	-
16 (400) x .125 x 1 DP - Wide Notch	542759338	542759372	-
16 (400) x .140 x 1 DP - Wide Notch	542759339	542759373	-
18 (457) x .125 x 1 DP - Wide Notch	542759340	542759374	-
18 (457) x .140 x 1 DP - Wide Notch	542759341	542759375	-
18 (457) x .165 x 1 DP - Wide Notch	542759342	-	-
18 (457) x .187 x 1 DP - Wide Notch	542759343	542759377	-
24 (600) x .165 x 1 DP LOU - Wide Notch	542759344	-	-
24 (600) x .187 x 1 DP LOU - Wide Notch	542759345	542759379	-
26 (660) x .165 x 1 DP LOU - Wide Notch	586027501	542759380	-
26 (660) x .187 x 1 DP LOU - Wide Notch	542759347	542759381	-
30 (762) x .165 x 1 DP LOU - Wide Notch	542759348	-	-
30 (762) x .187 x 1 DP LOU - Wide Notch	542759349	542759383	-
36 (914) x .187 x 1 DP LOU - Wide Notch	542759350	542776600	-

125"-187" width blades: total segment height is .570" (.450" diamond depth, .120" segment base) | 220" & above width blades: total segment height is .500" (.380" diamond depth, .120" segment base)



# Diamond Blades for Flat Sawing

## Professional® F600C Series CURED CONCRETE BLADES

- F605C: 35-50 HP, hard river rock aggregate with heavy reinforcement
- F610C: 35-50 HP, hard river rock aggregate and bridge deck with heavy steel reinforcement
- F620C: 35-50 HP, medium hard aggregate with medium steel reinforcement



### F600C Series | Wet Cutting | Laser Welded | Brazed

Sizes - Inches (mm)	F605C* Part Number	F610C Part Number	F620C Part Number
14 (350) x .125 x 1 DP - Narrow Notch	591498701	542758878	542758924
14 (350) x .140 x 1 DP - Narrow Notch	593072001	542758879	542758925
14 (350) x .165 x 1 DP - Narrow Notch	593072002	542758880	542758926
14 (350) x .187 x 1 DP - Narrow Notch	593072003	542758881	542758927
14 (350) x .250 x 1 DP - Narrow Notch	593072004	542758882	542758928
16 (400) x .125 x 1 DP - Narrow Notch	591110601	542758883	542758929
16 (400) x .140 x 1 DP - Narrow Notch	591102201	542758884	542758930
18 (457) x .125 x 1 DP - Narrow Notch	591498702	542758885	542758931
18 (457) x .140 x 1 DP - Narrow Notch	590885801	542758886	542758932
18 (457) x .155 x 1 DP - Narrow Notch	592830401	542758887	542758933
18 (457) x .165 x 1 DP - Narrow Notch	593072005	542758888	542758934
18 (457) x .187 x 1 DP - Narrow Notch	593072006	542758889	542758935
18 (457) x .250 x 1 DP - Narrow Notch	593072007	542758891	542758937
20 (508) x .125 x 1 DP LOU - Narrow Notch	593072008	582832902	591396601
20 (508) x .140 x 1 DP LOU - Narrow Notch	590505101	542758893	591396701
20 (508) x .165 x 1 DP LOU - Narrow Notch	590783801	590732702	582486202
24 (600) x .155 x 1 DP LOU - Narrow Notch	593072009	542758898	591172501
24 (600) x .165 x 1 DP LOU - Narrow Notch	590197401	542758899	591188201
24 (600) x .187 x 1 DP LOU - Narrow Notch	593072010	542758900	542758946
24 (600) x .220 x 1 DP LOU - Narrow Notch	593072011	542758901	542758947
26 (660) x .155 x 1 DP LOU - Narrow Notch	591193101	542758902	590878401
26 (660) x .165 x 1 DP LOU - Narrow Notch	590594801	590914401	590921701
26 (660) x .187 x 1 DP LOU - Narrow Notch	593072012	542758904	542758950
26 (660) x .220 x 1 DP LOU - Narrow Notch	593072013	542758905	542758951
30 (762) x .165 x 1 DP LOU - Narrow Notch	590517901	586846002	590723501
30 (762) x .187 x 1 DP LOU - Narrow Notch	593072014	542758908	593001001
30 (762) x .220 x 1 DP LOU - Narrow Notch	593072015	542758909	542758955
36 (914) x .165 x 1 DP LOU - Narrow Notch	591092601	542758910	590571701
36 (914) x .187 x 1 DP LOU - Narrow Notch	593072016	542758911	590572401
36 (914) x .220 x 1 DP LOU - Narrow Notch	593072017	542758912	542758958
42 (1,067) x .187 x 1 DP LOU - Wide Notch	-	542758918	-
42 (1,067) x .220 x 1 DP LOU - Wide Notch	-	542758919	-
48 (1,219) x .187 x 1 DP LOU - Wide Notch	-	542758920	-
48 (1,219) x .220 x 1 DP LOU - Wide Notch	-	542758921	-

125"-187" width blades: total segment height is .570" (.450" diamond depth; .120" segment base) | 220" & above width blades: total segment height is .500" (.380" diamond depth; .120" segment base) | Blades <20": no undercut protection. Blades > 24": undercut protection (recessed segments) | \*No undercut protection

# Diamond Blades for Flat Sawing

## Professional® F6000 Series ASPHALT OVERLAY BLADES

- F6500: 35-50 HP, general purpose asphalt over concrete with medium hard aggregate
- All blades have recessed segments

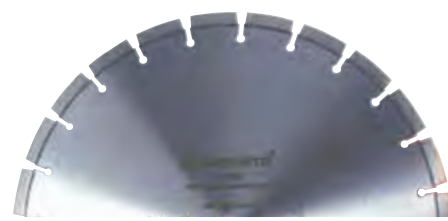

### F600C Series | Wet Cutting | Laser Welded

Sizes - Inches (mm)	F6500 Part Number
14 (350) x .125 x 1 DP - Narrow Notch	597157401
14 (350) x .187 x 1 DP - Narrow Notch	597157402
14 (350) x .250 x 1 DP - Narrow Notch	597157403
18 (457) x .125 x 1 DP - Narrow Notch	597157404
18 (457) x .165 x 1 DP - Narrow Notch	597157405
18 (457) x .187 x 1 DP - Narrow Notch	597157406
18 (457) x .250 x 1 DP - Narrow Notch	597157407
24 (600) x .165 x 1 DP LOU - Narrow Notch	582214601
24 (600) x .187 x 1 DP LOU - Narrow Notch	582214901
26 (660) x .165 x 1 DP LOU - Narrow Notch	582215001
26 (660) x .187 x 1 DP LOU - Narrow Notch	582215101
26 (660) x .250 x 1 DP LOU - Narrow Notch	582215201
30 (762) x .165 x 1 DP LOU - Narrow Notch	582215301
30 (762) x .187 x 1 DP LOU - Narrow Notch	582215701
30 (762) x .250 x 1 DP LOU - Narrow Notch	582215801
36 (914) x .165 x 1 DP LOU - Narrow Notch	582215901
36 (914) x .187 x 1 DP LOU - Narrow Notch	582216001
36 (914) x .250 x 1 DP LOU - Narrow Notch	582216101

## Professional® F600A Series ASPHALT BLADES

- F680A: 35-50 HP, general purpose asphalt with medium hard aggregate
- All blades have recessed segments

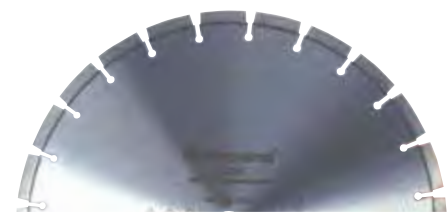

### F600A Series | Wet Cutting | Laser Welded

Sizes - Inches (mm)	F680A Part Number
14 (350) x .125 x 1 DP - Narrow Notch	597157601
14 (350) x .140 x 1 DP - Narrow Notch	597157602
14 (350) x .187 x 1 DP - Narrow Notch	597157603
14 (350) x .250 x 1 DP - Narrow Notch	597157604
18 (457) x .125 x 1 DP - Narrow Notch	597157605
18 (457) x .140 x 1 DP - Narrow Notch	597157606
18 (457) x .165 x 1 DP - Narrow Notch	597157607
18 (457) x .187 x 1 DP - Narrow Notch	597157608
20 (508) x .140 x 1 DP LOU - Narrow Notch	582223101
20 (508) x .165 x 1 DP LOU - Narrow Notch	582223201
24 (600) x .165 x 1 DP LOU - Narrow Notch	582223301
24 (600) x .187 x 1 DP LOU - Narrow Notch	582223401
26 (660) x .165 x 1 DP LOU - Narrow Notch	582223601
26 (660) x .187 x 1 DP LOU - Narrow Notch	582223701

125"-187" width blades: total segment height is .570" (.450" diamond depth; .120" segment base) | 220" & above width blades: total segment height is .500" (.380" diamond depth; .120" segment base)

# Diamond Blades for Flat Sawing

## Banner Line®

**HARD CONCRETE, GENERAL PURPOSE, GREEN CONCRETE, ASPHALT**

- Gold 150B: 20-50 HP, hard to critically hard aggregate with light to medium steel reinforcing.
- Blue 200B: 20-50 HP, general purpose soft to medium-hard aggregate with light steel reinforcing.
- Red 450B-R: 20-50 HP, green concrete, asphalt over concrete, asphalt with hard aggregate. Undercut protection is standard on this blade.
- Black 500B-R: 20-50 HP, abrasive asphalt. Undercut protection is standard on this blade.

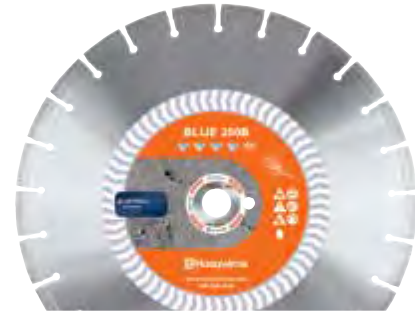

### Banner Line | Wet Cutting | Laser Welded

Sizes - Inches (mm)	Gold 150B Part No.	Blue 200B Part No.	Red 450B-R Part No.	Black 500B-R Part No.
14 (350) x .110 x 1 DP - Narrow Notch	542751019	542751031	542751062	542751074
14 (350) x .125 x 1 DP - Narrow Notch	542751020	542751032	542751063	542751075
14 (350) x .250 x 1 DP - Narrow Notch	542751021	542751033	542751064	542751076
16 (400) x .125 x 1 DP - Narrow Notch	542766418	542751034	542751367	542751077
18 (457) x .125 x 1 DP - Narrow Notch	542751022	542751036	542751065	542751078
20 (508) x .125 x 1 DP - Narrow Notch	542751023	542751037	542751066	542751079
24 (600) x .165 x 1 DP - Narrow Notch	542751025	542751039	542751068	542751081
26 (660) x .165 x 1 DP - Wide Notch	542751026	542751040	542751069	542751082
26 (660) x .187 x 1 DP - Wide Notch	542751449	542751450	542751452	542751453
30 (762) x .165 x 1 DP - Wide Notch	542751027	542751041	542751070	542751083
30 (762) x .187 x 1 DP - Wide Notch	-	542751455	542751457	542751458
36 (914) x .165 x 1 DP - Wide Notch	542766419	542751042	542751071	542751084

Total segment height is .390" (.315" diamond depth, .075" segment base).

## Vari-Cut™ Plus

**GENERAL PURPOSE, ABRASIVE MATERIAL BLADES**

- Vari-Cut™ Plus: <20 HP, general purpose, cured concrete, abrasive material and light asphalt overlay with undercutting protection.



### Vari-Cut Plus | Wet Cutting | Laser Welded

Sizes - Inches (mm)	Part Number
14 (350) x .125 x 1 DP - 20 mm B	585580801
16 (400) x .125 x 1 DP - 20 mm B	585580802
18 (457) x .140 x 1 DP	585580803
20 (450) x .140 x 1 DP	585580804

Total segment height is .400" (.300" diamond depth, .100" segment base).



# Specialty Diamond Blades for Flat Sawing

## Professional® Traffic Loop

TRAFFIC LOOP BLADES, 35-85 HP

- Sandwich segment maintains consistent joint width.
- Blades greater than .375" thick are brazed.
- L13 blades through .375" thick have vertical insert undercut protection.



### Traffic Loop | Wet Cutting | Laser Welded | Brazed

Sizes - Inches (mm)	L3 Concrete Part Number	L13 Asphalt Part Number
12 (305) x .250 x 1 DP - Narrow Notch	542751000	593043102
12 (305) x .312 x 1 DP - Narrow Notch	542751001	593043103
12 (305) x .375 x 1 DP - Narrow Notch	542751002	542751010
12 (305) x .500 x 1 DP - Narrow Notch	542751003	542751011
14 (350) x .250 x 1 DP - Narrow Notch	542751004	542751012
14 (350) x .312 x 1 DP - Narrow Notch	542751005	542751013
14 (350) x .375 x 1 DP - Narrow Notch	542751006	542751014
14 (350) x .500 x 1 DP - Narrow Notch	542751007	542751015

125"-187" width blades: total segment height is .570" (.450" diamond depth, .120" segment base) | .220" & above width blades: total segment height is .500" (.380" diamond depth, .120" segment base)

## Professional® JW Series

JOINT WIDENING BLADES, 20-85 HP

- JW30: hard concrete, river gravel and flint aggregate.
- JW40: medium to soft concrete with limestone aggregate.
- Joint widening blades do not have undercut protection.

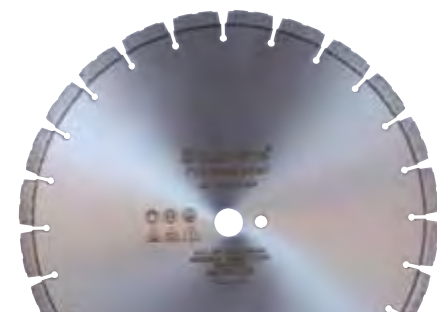

### JW Series | Wet Cutting | Laser Welded

Sizes - Inches (mm)	JW30 Part Number	JW40 Part Number
12 (305) x .187 x 1 DP - Narrow Notch	542759573	542759579
12 (305) x .220 x 1 DP - Narrow Notch	542759574	542759580
12 (305) x .250 x 1 DP - Narrow Notch	542759575	542759581
14 (350) x .187 x 1 DP - Narrow Notch	542759576	542759582
14 (350) x .220 x 1 DP - Narrow Notch	542759577	542759583
14 (350) x .250 x 1 DP - Narrow Notch	542759578	542759584

125"-187" width blades: total segment height is .570" (.450" diamond depth, .120" segment base) | .220" & above width blades: total segment height is .500" (.380" diamond depth, .120" segment base)

### Spacers for Joint Widening Blades

Spacer Sizes - Inches (mm)	Blade Segment Width, Inches (mm)	Part Number
8 (203) x .032 x 1 DP	.125-.187	541202367
8 (203) x .064 x 1 DP	.220-.250	541202368
8 (203) x .105 x 1 DP	-	541202369
8 (203) x .135 x 1 DP	-	541202370

.375" wide cut. Use two 187" blades with spacer 541202367 | .500" wide cut. Use two .250" blades with spacer 541202368

# Specialty Diamond Blades for Flat Sawing

## Professional® Slinger SPECIALTY BLADE, 20-85 HP

- Removes joint material on joint resealing projects.



### Slinger

Sizes - Inches (mm)	Part Number
14 (350) x .250 x 1 DP	541006326

## Professional® Joint Beveling JOINT BECELING BLADES, 20-85 HP

- Features long life, low cutting cost per foot and high production efficiencies on large jobs.
- Bevel blades are typically used as a set of two blades.
- Pricing indicates list price of a single blade.



### Joint Beveling | Wet Cutting | Brazed

Sizes - Inches (mm)	Part Number
8 (203) x .250 x 1 DP - Narrow Notch	542774286
8 (203) x .375 x 1 DP - Narrow Notch	542774287
12 (305) x .250 x 1 DP - Narrow Notch	542774288
12 (305) x .375 x 1 DP - Narrow Notch	542774289
12 (305) x .500 x 1 DP - Narrow Notch	542774290

125"-187" width blades: total segment height is .570" (.450" diamond depth, .120" segment base) | 220" & above width blades: total segment height is .500" (.380" diamond depth, .120" segment base)

## Husqvarna SD5+ GREEN CONCRETE BLADES, 1.5-8 HP

- SD5+: green concrete



### SD5+ | Dry or Wet Cutting | Laser Welded

Sizes - Inches (mm)	Part Number
7 (178) x .095 x 5/8	542751135
8 (203) x .095 x 5/8	542751139
8 (203) x .125 x 5/8	542751141
9 (230) x .095 x 5/8	542751143
10 (254) x .125 x 5/8	542774717
10 (254) x .125 x 1DP	542777040

Total segment height is .450" (.375" diamond depth, .075" segment base)

# Specialty Diamond Blades for Flat Sawing

## Banner Line® Crack Saws

HARD CONCRETE, 5-20 HP

- Blue 200B: shallow pavement cracks.



**Crack Saws | Dry or Wet Cutting | Laser Welded | Brazed**

Sizes - Inches (mm)	Part Number
8 (203) x .250 x 1 DP	542751043
8 (203) x .375 x 1 DP	542751044
8 (203) x .500 x 1 DP	542751045

Total segment height is .335" (.260" diamond depth, .07" segment base)

## Wire Joint Brush, 2 pack

HARD CONCRETE, ASPHALT BRUSHES, 5-20 HP

- Wire Joint Brush: joint or crack cleaning in concrete or asphalt.
- Oil tempered steel wire with a 3/8" face width. Some machine models may require modification to accept a wire joint brush.
- Requires 5/8" minimum blade clamping thickness. Packaged 2 per box.



**Wire Joint Brush | Dry Cutting**

Sizes - Inches (mm)	Part Number
12 (305) X 3/8 X 1 DP	574233201

## GC Concrete Abrasive

GREEN CONCRETE, ASPHALT, 18-65 HP

- Green concrete with soft to medium aggregates, highly abrasive asphalt, green concrete aggregate.
- Metal arbor hole insert molded into the blade for extra strength and protection of the driveshaft.
- List price is for one blade, must order in packaged quantities of 10/box (item no. 542751460 - 542751462) or 5/box (item no. 542751463 - 542751466).



**GC Concrete Abrasive | Dry Cutting**

Sizes - Inches (mm)	Part Number
14 (350) x 3/16 x 1 DP	542751460
14 (350) x 1/4 x 1 DP	542751462
14 (350) x 3/8 x 1 DP	542751463
18 (457) x 1/4 x 1 DP	542751465
18 (457) x 3/8 x 1 DP	542751466

# IMAGINE YOUR FAVORITE POWER CUTTER - AND THEN IMAGINE IT GETS BETTER

No matter how good our power cutters and diamond tools get, we never stop improving. We strive to get better because we focus on you, the user - how you work now and how we can help improve it. That is why our machines continue to be perfectly balanced, easy to use and lightweight. In addition, our outstanding reliability, power and ergonomics mean you can stay focused on getting the job completed with great results every time. To put it simply, you can always expect more from a Husqvarna.



## Husqvarna DEX Dust Suppression System

Husqvarna's dust suppression system, DEX, helps to minimize dust and water usage. DEX features a progressive water valve that is fitted with distinct end positions, making it easy to set the exact water flow for any application, which minimizes water consumption and slurry.

## Range Overview

Husqvarna has the widest range of handheld power cutters on the market, containing no less than 21 different models, with cutting depths up to 17 in (432 mm). Regardless of your preferred power source – gas, electric, battery, hydraulic or pneumatic – you will find the power cutter for your job here. The chart below shows a compressed view of our wide range of power cutter options.

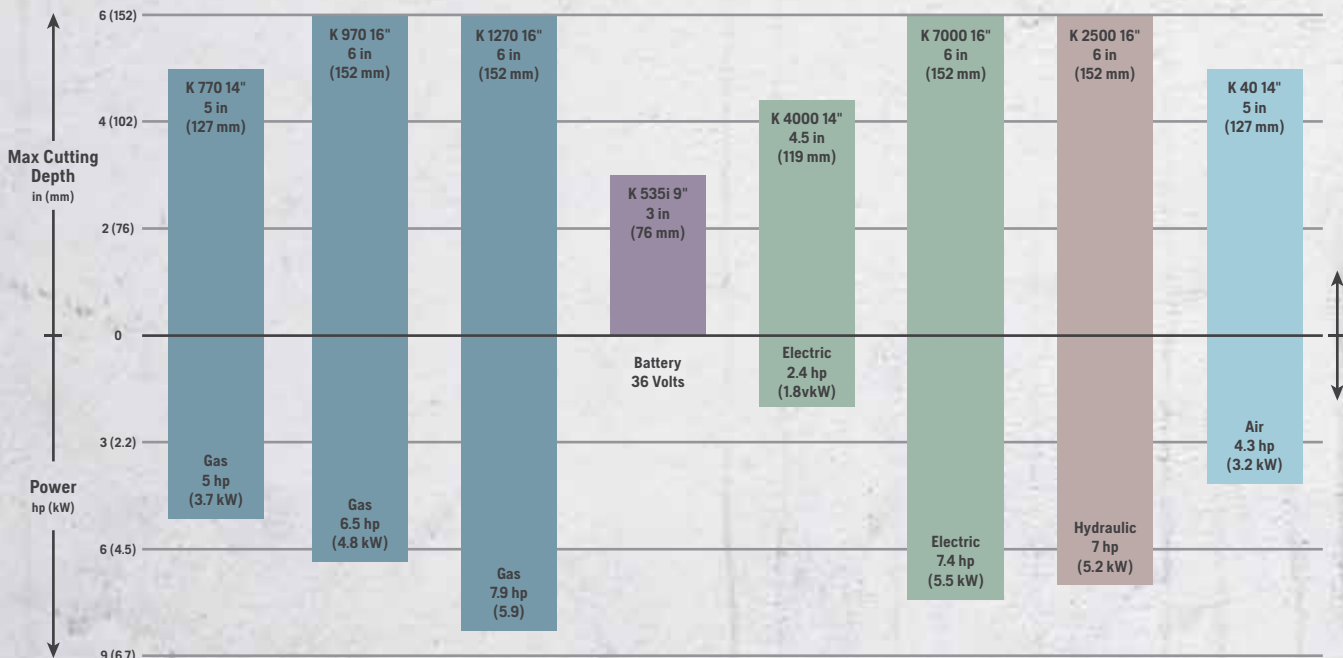





Whether you're an experienced concrete cutter or a newcomer to the game, you'll appreciate the reliable power and versatility provided by the all-new PRIME™ equipment from Husqvarna. In fact, we believe that the more experience you have from various cutting jobs and equipment setups, the more you will appreciate this new generation of PRIME™ equipment.

Why? Because it combines the simplicity, user-friendliness and low weight of electrical systems with the advantages of hydraulic systems. But without the heavy hoses or the risk of oil spills. All of which adds up to you getting more done in a day at work.

Since the PRIME™ product range was introduced in 2013, it has been expanded and refined throughout. Now it's time to introduce a new generation, built around the all-new, intelligent and extremely sturdy Husqvarna PP 70 power pack. A new generation of PRIME™ equipment, with all of Husqvarna's knowledge and experience built in.

Husqvarna K 7000 is the new version of Husqvarna's 16-inch PRIME™ power cutter. A machine that is continuously gathering new fans attracted by the high power and easy handling, useful in many applications both indoors and outdoors. Delivering 6 in (155 mm) cutting depth, this model is very useful for pre-cutting.

Husqvarna K 7000 Ring is the new version of Husqvarna's game-changing handheld ring power cutter in the PRIME™ equipment range. Available in both 14- and 17-inch versions, offering up to 13 in (325 mm) cutting depth. Powerful, well-balanced and low-weight, these machines are the ideal choices no matter what kind of handheld deep cutting job you're up to, indoors as well as outdoors.

Husqvarna K 7000 Chain is the new version of Husqvarna's versatile PRIME™ chain power cutter. This machine is very useful in all handheld applications where you demand high precision without over-cutting, such as narrow plunge cuts and corner-cutting of openings for doors and windows.

# Gas Power Cutters

## Applications

- Can be used for a variety of cutting applications including curbstones and pavers in landscaping, metal/pipes in installation work, concrete in buildings as well as roadwork applications.

1 YEAR  
WARRANTY

## Benefits

- SmartTension, semi-automatic belt tensioning
- Optimized engine performance and 5% fuel savings through new efficient cylinder design, digital ignition system and X-Torq® engine technology.
- DEX, dust suppression system, makes it easy to ensure dust is reduced while minimizing water consumption and slurry.



Power Cutter Models	K 770	K 770 Oilguard
12" - Part No. (blade not included)	967808501	-
14" - Part No. (blade not included)	967682101	967691101

## Technical Specifications

Blade, in (mm)	12/14 (300/350)	14 (350)
Cutting depth, in (mm)	4/5 (100/127)	5 (127)
Power, hp (kW)	5 (3.7)	5 (3.7)
Displacement, cu in (cc)	4.48 (74)	4.48 (74)
Power/weight ratio, hp/lbs (kW/kgs)	.24/.23 (.39/.38)	.23 (.38)
Weight, without fuel and cutting equipment, lbs (kgs)	21.2/21.6 (9.6/9.8)	21.6 (9.8)
Fuel capacity, qt (L)	.95 (.09)	.95 (.09)
Sound power level lwa, db(a)	115	115
Sound pressure level, db(a)	101	101
Vibrations front handle equivalent, m/s <sup>2</sup>	2.1	2.1
Vibrations rear handle equivalent, m/s <sup>2</sup>	2.3	2.3

## Features

X-torq®, air-cooled 2-stroke engine	Yes	Yes
Active air filtration™	Yes	Yes
Smartcarb™	Yes	Yes
Durastarter™	Yes	Yes
Easystart™	Yes	Yes
Reversible cutting arm	Yes	Yes
Fuel indicator in the tank	Yes	Yes
Easy-adjust blade guard	Yes	Yes
Wet kit	Yes	Yes
Replaceable arbor bushing	Yes	Yes

# Gas Power Cutters

## Applications

- Can be used for a variety of dry cutting applications including curbstones and pavers in landscaping, metal/pipes in installation work, concrete in buildings as well as roadwork applications.

## Benefits

- SmartTension, semi-automatic belt tensioning
- Optimized engine performance and 5% fuel savings through new efficient cylinder design, digital ignition system and X-Torq® engine technology.
- The double, foldable protections on the blade guard enable better dust handling and fold into the blade guard during operation.

1 YEAR  
WARRANTY

Power Cutter Models	K 770 Vac	K 770 Drycut
12" - Part No. (blade not included)	967860701	967942001

## Technical Specifications

Blade, in (mm)	12 (300)	12 (300)
Cutting depth, in (mm)	5 (127)	5 (127)
Power, hp (kW)	5 (3.7)	5 (3.7)
Displacement, cu in (cc)	4.48 (74)	4.48 (74)
Power/weight ratio, hp/lbs (kW/kgs)	.21 (.34)	.21 (.34)
Weight, without fuel and cutting equipment, lbs (kgs)	24.2 (11)	24.2 (11)
Fuel capacity, qt (L)	.95 (.09)	.95 (.09)
Sound power level lwa, db(a)	115	115
Sound pressure level, db(a)	112	112
Vibrations front handle equivalent, m/s <sup>2</sup>	4.0	3.3
Vibrations rear handle equivalent, m/s <sup>2</sup>	2.8	4.4

## Features

X-torq®, air-cooled 2-stroke engine	Yes	Yes
Active air filtration™	Yes	Yes
Smartcarb™	Yes	Yes
Durastarter™	Yes	Yes
Easystart™	Yes	Yes
Reversible cutting arm	No	No
Fuel indicator in the tank	Yes	Yes
Easy-adjust blade guard	Yes	Yes
Wet kit	Yes	Yes
Replaceable arbor bushing	Yes	Yes



# Gas Power Cutters

## Applications

- Can be used for a variety of cutting applications including curbstones and pavers in landscaping, metal/pipes in installation work, concrete in buildings as well as roadwork applications.

1 YEAR  
WARRANTY

## Benefits

- SmartTension, semi-automatic belt tensioning.
- Optimized engine performance and 5% fuel savings through new efficient cylinder design, digital ignition system and X-Torq® engine technology.
- Extended blade guard reduces the likelihood of accidents and circumstances when a kickback may occur as it emphasizes correct cutting technique and cutting zone.



Power Cutter Models	K 770 SmartGuard	K 970 SmartGuard
14" - Part No. (blade not included)	970460001	970460101

## Technical Specifications

Blade, in (mm)	14 (350)	14 (350)
Cutting depth, in (mm)	5 (127)	5 (127)
Power, hp (kW)	5 (3.7)	6.4 (4.8)
Displacement, cu in (cc)	4.48 (74)	5.71 (74)
Power/weight ratio, hp/lbs (kW/kgs)	.23 (.38)	.27 (.44)
Weight, without fuel and cutting equipment, lbs (kgs)	24.5 (11.1)	26.3 (11.9)
Fuel capacity, qt (L)	.95 (.09)	1.1 (1)
Sound power level lwa, db(a)	115	115
Sound pressure level, db(a)	101	104
Vibrations front handle equivalent, m/s <sup>2</sup>	2.1	4.2
Vibrations rear handle equivalent, m/s <sup>2</sup>	2.0	3.7

## Features

X-torq®, air-cooled 2-stroke engine	Yes	Yes
Active air filtration™	Yes	Yes
Smartcarb™	Yes	Yes
Durastarter™	Yes	Yes
Easystart™	Yes	Yes
Reversible cutting arm	Yes	Yes
Fuel indicator in the tank	Yes	Yes
Easy-adjust blade guard	Yes	Yes
Wet kit	Yes	Yes
Replaceable arbor bushing	Yes	Yes

[CLICK HERE TO SEE IT IN ACTION!](#)



# Gas Power Cutters

## Applications

- Can be used for a variety of cutting applications including curbstones and pavers in landscaping, metal/pipes in installation work, concrete in buildings as well as roadwork applications.

1 YEAR  
WARRANTY

## Benefits

- SmartTension, semi-automatic belt tensioning.
- Optimized engine performance and 5% fuel savings through new efficient cylinder design, digital ignition system and X-Torq® engine technology.
- DEX, dust suppression system, makes it easy to ensure dust is reduced while minimizing water consumption and slurry.



Power Cutter Models	K 970	K 1270
14" - Part No. (blade not included)	967348001	967978701
16" - Part No. (blade not included)	967348101	967978801

## Technical Specifications

Blade, in (mm)	14/16 (350/400)	14/16 (350/400)
Cutting depth, in (mm)	5/6 (127/152)	5/6 (127/152)
Power, hp (kW)	6.5 (4.8)	7.9 (4.8)
Displacement, cu in (cc)	5.71 (93.6)	7.25 (119)
Power/weight ratio, hp/lbs (kW/kgs)	.27/.26 (.44/.43)	.26/.24 (.42/.40)
Weight, without fuel and cutting equipment, lbs (kgs)	24.3/25.6 (11/11.6)	30.2/32.1 (13.6/14.4)
Fuel capacity, qt (L)	1.1 (1)	1.3 (1.2)
Sound power level lwa, db(a)	115	118
Sound pressure level, db(a)	102	102
Vibrations front handle equivalent, m/s <sup>2</sup>	3.0/2.7	3.3/3.6
Vibrations rear handle equivalent, m/s <sup>2</sup>	3.8/4.0	3.5/4.1

Features	K 970	K 1270
X-torq®, air-cooled 2-stroke engine	Yes	Yes
Active air filtration™	Yes	Yes
Smartcarb™	Yes	Yes
Durastarter™	Yes	No
Easystart™	Yes	Yes
Reversible cutting arm	Yes	Yes
Fuel indicator in the tank	Yes	No
Easy-adjust blade guard	Yes	Yes
Wet kit	Yes	Yes
Replaceable arbor bushing	Yes	Yes

# Deep Cutting Gas Power Cutters

## Applications

- Designed to cut deep, using a step-cut method, when you need to make/adjust openings.

## Benefits

- Optimized engine performance and 5% fuel savings through new efficient cylinder design, digital ignition system and X-Torq® engine technology.
- The unique cut-n-break method enables operators to work through the material step-by-step at a low tool cost.
- The adjustable water valve makes it easy to ensure dust is reduced while minimizing water consumption and slurry.



Power Cutter Models	K 760 Cut-N-Break
Part No. (set of blades and breaker bar included)	967195701

## Technical Specifications

Blade, in (mm)	9 (228)
Cutting depth, in (mm)	16 (400)
Power, hp (kw)	5 (3.7)
Displacement, cu in (cc)	4.48 (74)
Power/weight ratio, hp/lbs (kw/kg)	.24 (.39)
Weight, without fuel and cutting equipment, lbs (kg)	20.7 (9.4)
Fuel capacity, qt (l)	.95 (0.9)
Sound power level lwa, db(a)	113
Sound pressure level, db(a)	101
Vibrations front handle equivalent, m/s <sup>2</sup>	1.9
Vibrations rear handle equivalent, m/s <sup>2</sup>	2.8

Features	
Air-cooled 2-stroke engine	Yes
Active Air Filtration™	Yes
X-torq®	Yes
Smartcarb™	Yes
Durastarter™	Yes
Easystart™	Yes
Fuel indicator in the tank	Yes
Wet kit	Yes

[CLICK HERE TO SEE IT IN ACTION!](#)

# Deep Cutting Gas Power Cutters

## Applications

- Deep cutting irregular openings in concrete, stone & masonry.

1 YEAR  
WARRANTY

## Benefits

- Optimized engine performance and 5% fuel savings through new efficient cylinder design, digital ignition system and X-Torq® engine technology.
- The Poly V-belt provides better power transmission, less extensioning and increased product life.
- The adjustable water valve makes it easy to ensure dust is reduced while minimizing water consumption and slurry.
- New two-bolt guide bar solution on the K 970 Chain makes tensioning easy.



Power Cutter Models	K 970 Ring	K 970 Chain
Part No. (blade/bar & chain not included)	967272301	967660501

## Technical Specifications

Blade, in (mm)	14 (350)	N/a
Cutting depth, in (mm)	10 (254)	13/15/17 (330/380/432)
Power, hp (kW)	6.5 (4.8)	6.5 (4.8)
Displacement, cu in (cc)	5.71 (93.6)	5.71 (93.6)
Power/weight ratio, hp/lbs (kW/kgs)	.21 (.34)	.30 (.48)
Weight, without fuel and cutting equipment, lbs (kgs)	29.8 (13.5)	21.4 (9.7)
Fuel capacity, qt (L)	1.1 (1)	1.1 (1)
Sound power level lwa, db(a)	116	116
Sound pressure level, db(a)	103	103
Vibrations front handle equivalent, m/s <sup>2</sup>	3.8	3.6
Vibrations rear handle equivalent, m/s <sup>2</sup>	5.1	2.3

## Features

Air-cooled 2-stroke engine	Yes	Yes
Active Air Filtration™	Yes	Yes
X-torq®	Yes	Yes
Smartcarb™	Yes	Yes
Durastarter™	Yes	Yes
Easystart™	Yes	Yes
Fuel indicator in the tank	Yes	Yes
Easy-adjust blade guard	Yes	Yes
Wet kit	Yes	Yes
Replaceable arbor bushing	Yes	NA

# Battery Power Cutters

## Applications

- Perfect for cutting rebar, landscape pavers, brick, block and 3" deep in concrete.

## Benefits

- Reliable quick starts and creates a cutting option when gas or electric aren't as available.
- Easy-to-maneuver and control, due to the blade's placement closer to the center of the machine.



Power Cutter Models	K 535i
Part No. (includes Tacti-Cut blade, battery not included)	967795902
Part No. (includes Tacti-Cut blade, BLi 200 battery & QC 330 charger)	967795903

## Technical Specifications

Blade, in (mm)	9 (229)
Cutting depth, in (mm)	3 (76)
Battery type	Li-ion
Voltage, V	36
Motor type	BLDC (brushless)
Sound power level Lwa, dB(A)	111
Sound pressure level, dB(A)	110
Vibration front handle equivalent, m/s <sup>2</sup>	2.1
Vibration rear handle equivalent, m/s <sup>2</sup>	2.5
Weight without cutting equipment, lbs (kgs)	7.7 (3.5)

Features	
Controlled blade speed	Yes
Wet kit	Integrated
SavE	Yes

Battery Models	BLi 100	BLi 200	BLi 300	BLi 550X	BLi 950X
Part No.	967963902	967964102	967964302	967964502	967964602
Battery capacity, Ah	4.0	5.2	9.4	15.6	31.1
Battery output power, Wh	144	187	337	561	1120
Battery type	Li-Ion	Li-Ion	Li-Ion	Li-Ion	Li-Ion
Battery voltage, V	36	36	36	36	36
Cells per battery	20	20	30	60	90
Battery weight, lbs (kg)	2.7 (1.2)	2.9 (1.3)	4.2 (1.9)	17.5 (99.5)	20.7 (94)
Connectivity, Bluetooth	No	No	No	Yes	Yes

[FOR ADDITIONAL BATTERY PRODUCTS CLICK HERE!](#)



# Electric Power Cutters

## Applications

- Perfect to use when cutting indoors.

## Benefits

- Elgard™, the advanced electronic overload protection system, varies the rotation speed to warn of an approaching overload.
- Pop-up carbon brushes increase motor life.
- Lightweight, quiet-running, 2.4 hp
- DEX, dust suppression system, makes it easy to ensure dust is reduced while minimizing water consumption and slurry.

1 YEAR  
WARRANTY

POWER CUTTERS

Power Cutter Models	K 4000 Wet	K 4000 Cut-N-Break
Part No. (includes wet kit w/GFCI. blade not included)	967084001	-
Part No. (breaker bar & set of blades included)	-	967083301

## Technical Specifications

Blade, in (mm)	14 (350)	9 (228)
Cutting depth with vac unit, in (mm)	4.5 (119)	n/a
Cutting depth without vac unit, in (mm)	5 (127)	n/a
Cutting depth, in (mm)	n/a	16 (400)
Electric motor, volts	120	120
Rated output, hp (watts)	2.4 (1,800)	2.4 (1,800)
Rated current, amps	15	15
Weight including cable, not including cutting equipment or vac unit, lbs (kg)	17.4 (7.9)	18 (8.2)
Sound power level Lwa, dB(A)	105	109
Sound pressure level, dB(A)	95	95
Vibration handle equivalent, m/s <sup>2</sup>	3.5	3.4
Recommended minimum size generator, kW*	5	5
Wire/Cable/Extension cord size	12AWG / 50 feet	12AWG / 50 feet
Wire/Cable/Extension cord size	10AWG /100 feet	10AWG /100 feet

## Features

Elgard™, overload protection	Yes	Yes
"Pulling" rotation (downcutting)	Yes	Yes
Simple blade change	Yes	Yes
Replaceable arbor bushing	Yes	No
Wet kit	Yes	Yes

**NOTICE!** Good motor performance depends on proper voltage. Extension cables that are too long and/or which have a gauge that is too small, reduce power to the motor under load, resulting in reduced output or malfunctions. \*Always read generator OM and follow national and local electrical codes

# NEW Prime High Frequency Power Cutters



## Applications

- Perfect for wet cutting of concrete, stone and masonry in buildings as well as pipe cutting in pipe trenches.

## Benefits

- A powerful saw that operates on both 3/1 phase power.
- Low vibration levels mean less operator fatigue.
- Built-in intelligence ensures optimal power and RPMs for each cutting job (LED meter).
- DEX, dust suppression system, makes it easy to ensure dust is reduced while minimizing water consumption & slurry.



POWER CUTTERS

Power Cutter Models	K 7000 16"
Part No. (blade & power pack not included)	970449601

## Technical Specifications

Blade, in (mm)	16 (400)
Cutting depth, in (mm)	6 (155)
High frequency electric motor, volts	120-240/200-480
Power 3-phase/1-phase, hp (kw)	2-4/7.4 (1.5-3/5.5)
Rated current, amp	10/16
Weight without blade, lbs (kg)	21.6 (9.8)
Sound power level lwa, db(a)	111
Sound pressure level, db(a)	93
Vibrations front handle equivalent, m/s <sup>2</sup>	< 1.8
Vibrations rear handle equivalent, m/s <sup>2</sup>	< 1.8

## Features

Overload protection	Yes
"Pulling" rotation (downcutting)	Yes
Simple blade change	Yes
Replaceable arbor bushing	Yes
Wet kit	Yes
Cooling	Water
DEX	Yes

**NOTICE!** Good motor performance depends on proper voltage. Extension cables that are too long and/or which have a gauge that is too small, reduce power to the motor under load, resulting in reduced output or malfunctions. \*Always read generator OM and follow national and local electrical codes

[FOR ADDITIONAL PRIME PRODUCTS CLICK HERE!](#)

# NEW Prime High Frequency Power Cutters



## Applications

- Perfect for wet cutting of concrete, stone and masonry in buildings as well as pipe cutting in pipe trenches.

## Benefits

- A powerful saw that operates on both 3/1 phase power.
- Low vibration levels mean less operator fatigue.
- Built-in intelligence ensures optimal power and RPMs for each cutting job (LED meter).



1 YEAR WARRANTY

POWER CUTTERS

Power Cutter Models	14" K 7000 Ring	17" K 7000 Ring	K 7000 Chain
Part No. (blade/bar & chain not included)	970449801	970449901	970449701

## Technical Specifications

Blade, in (mm)	14 (350)	17 (432)	NA
Bar, in (mm)	NA	NA	16 (400)
Cutting depth, in (mm)	10.5 (270)	13 (324)	16 (400)
High frequency electric motor, volts	120-240/200-480	120-240/200-480	120-240/200-480
Power 3-phase/1-phase, hp (kW)	2-4/7.4 (1.5-3/5.5)	2-4/7.4 (1.5-3/5.5)	2-4/7.4 (1.5-3/5.5)
Rated current, amp	10/16	10/16	10/16
Weight without blade, lbs (kg)	27 (12.4)	27 (12.4)	20 (9.1)
Sound power level lwa, db(a)	111	111	112
Sound pressure level lwa, db(a)	99	99	99
Vibrations front handle equivalent, m/s <sup>2</sup>	< 2.7	< 2.7	< 2.4
Vibrations rear handle equivalent, m/s <sup>2</sup>	< 1.9	< 1.9	< 2.1

## Features

Overload protection	Yes	Yes	Yes
"Pulling" rotation (downcutting)	Yes	Yes	Yes
Simple blade change	Yes	Yes	Yes
Replaceable arbor bushing	No	No	NA
Wet kit	Yes	Yes	Yes
Cooling	Water	Water	Water

**NOTICE!** Good motor performance depends on proper voltage. Extension cables that are too long and/or which have a gauge that is too small, reduce power to the motor under load, resulting in reduced output or malfunctions. \*Always read generator OM and follow national and local electrical codes

[FOR ADDITIONAL PRIME PRODUCTS CLICK HERE!](#)

DIAMOND BLADE SECTION

PAGE 74

# Prime High Frequency Power Packs



## Applications

- Electric power pack for Husqvarna's K 7000, K 7000 Ring, K 7000 Chain and DM 700 high frequency products. (PP 70)
- Water-cooled electric high frequency power pack for the WS 220 wall saw, DM 700 drill motor, K 7000, K 7000 Ring and K 7000 Chain power cutters. (PP 220)

## Benefits

- Connects to both 3- and 1-phase power. (PP 70)
- Air-cooled – the water connection is needed only for wet cutting. (PP 70)
- A powerful, high frequency power pack providing fast and accurate adjustment for each operating condition. (PP 220)
- There is only one cable and one hose from converter to machine, which simplifies setup and transport. (PP 220)



Power Pack Models	PP 70	PP 220
Part No. (includes pigtails)	967828303	966563803

## Technical Specifications

Power 3-phase/1-phase, hp (kW)	2-4 (1.5-3) 1-phase/ 8.7 (6.5) 3-phase	8.7/4.7 (6.5/3.5)
Rated current, amp	15	16/10
Voltage 3-phase/1-phase, V	120-240/200-480	200-480/226-240
Cooling	Water	Water
Weight, lbs (kg)	40 (18)	24 (10.8)
Dimensions (W x H x L) in, mm	7 x 16 x 22.4 (183 x 410 x 570)	7.2 x 13.8 x 16.5 (183 x 350 x 567)
Recommended minimum size generator, kW	10	10

## Husqvarna WA 20 Wall Attachment

### Applications

- Enables the K 3600 and now the K 7000 Ring to easily attach to a wall to make cuts.

Wall Attachment Models	WA 20
WA 20 wall kit (two 1-meter rails and carriage)	506319302
WA 20 extra rail	506338703
WA 20 carriage mount adapter, K 6500 Ring	590708801
WA 20 carriage mount adapter, K 3600	506323301
WA 20 carriage mount Adapter, K 2500	506323501





# P16kVA Prime Generator



## Applications

- Generator designed to support PRIME range of equipment: PP 70, PP 220, K 7000, K 7000 Ring, K 7000 Chain and DM 700 high frequency products.

## Benefits

- Runs 480V 3-phase and 110V simultaneously.
- Durable galvanized frame and lifting point for transportation.
- Multi-cushion isolators reduce vibrations and the compact design facilitates transporting and storage.
- RFL permanent magnet alternator.



Generator Models	P16kVA
Part No.	967836201

## Technical Specifications

Generator	
Max output, HP (kW)	21 (16)
Frequency, Hz	60
Voltage, V	120/480 3-phase
Sockets	20A 125V GFCI UG Receptable, L 16-30R 30A 3-phase 480V Receptable
Dry weight, lbs (kg)	342 (155)
Noise level, dB	No Load - 72, 50% Load - 76, 100% Load - 78
Rated power factor	0.8
Engine	
Type, model	Twin cylinder air cooled petrol, Honda GX690
Starting system	Key Start
Displacement, cc	688
Fuel economy, gal/hr. (L/h)	.92 @ 50% load (3.5 @ 50% load)
Run time, hrs	10 @ 50% load
Fuel tank, gal (l)	8.98 (3.4)

# Hydraulic Power Cutters

## Applications

- Ideal for indoor and outdoor cutting of everything from brick to reinforced concrete.
- Designed for wet cutting only.

## Benefits

- The K 3600 MK II machine has a unique power-to-weight ratio and hydraulic drive that makes for a highly efficient and maneuverable handheld power cutter.
- The K 2500's high power output with hydraulic operation enables a 16" blade to cut smoothly through tough materials.



POWER CUTTERS

Power Cutter Models	K 3600 MK II	K 2500
Part No. (blades not included)	968424101	968365401

## Technical Specifications

Blade, in (mm)	14 (350)	16 (400)
Cutting depth, in (mm)	10 (254)	6 (152)
Power, hp (kW)	6 (4.4)	7 (5.2)
Maximum pressure, psi (bar)	2,200 (150)	2,200 (150)
Maximum flow rate, g/min (l/min)	10 (40)	10 (40)
Sound power level L <sub>wa</sub> , dB(A)	111	107
Sound pressure level, dB(A)	99	85
Vibrations front handle equivalent, m/s <sup>2</sup>	4.3	7.5
Vibrations rear handle equivalent, m/s <sup>2</sup>	6	5.2
Weight without blade, lbs (kg)	18.3 (8.3)	18.3 (8.3)

Features		
Hydraulic gear motor	Yes	Yes
Peripheral drive	Yes	NA
Adjustable front handle	Yes	NA
Automatic start for water flow	Yes	NA
Servo for rpm control	NA	Yes
Reversible cutting arm	NA	Yes
Wet kit	NA	Yes
Replaceable arbor bushing	NA	Yes

# Air Power Cutters

## Applications

- Perfect for cutting jobs such as pipe trenches, deep building foundations, shipyard docks and other construction, engineering and shipbuilding applications.

## Benefits

- Powerful and reliable air-powered industrial power cutter, ideal for use indoors or outdoors with access to compressed air.
- Ideal for use indoors and in dust-sensitive areas as there is no emission from oil or exhaust.
- The power cutter has a long, slim body with good weight.



Power Cutter Models	K 40
Part No. (blade not included)	968372401

## Technical Specifications

Blade, in (mm)	14 (350)
Cutting depth, in (mm)	5 (127)
Power, hp (kW)	4.3 (3.2)
Sound power level Lwa, dB(A)	107
Sound pressure level, dB(A)	92
Vibrations front handle equivalent, m/s <sup>2</sup>	9.5
Vibrations rear handle equivalent, m/s <sup>2</sup>	5.2
Air requirement, cfm (m <sup>3</sup> /min)	100-125 (2.8-3.5)
Maximum air pressure, psi (bar)	100 (7)
Weight without hose, mist lubricator and blade, lbs (kg)	21.6 (9.8)

## Features

Reversible cutting arm	Yes
Wet kit	Yes
Replaceable arbor bushing	Yes
Air motor	Yes
Automatic mist lubrication	Yes

# Rescue Power Cutters

## Applications

- The rescue saws create openings in buildings, trains and airplanes for search and rescue jobs.

1 YEAR  
WARRANTY

## Benefits

- Active Air Filtration™ efficiently cleans air.
- Semi-automatic SmartTension minimized the risk of under- or over-tensioning
- Magnesium blade guard with reflective tape, is visible in smoke and water spray, which enhances control of the cutter.



Power Cutter Models	K 770 Rescue	K 970 Rescue
Part No. (blade not included)	967809101	967635601

## Technical Specifications

Blade, in (mm)	12 (300)	14 (350)
Cutting depth, in (mm)	4 (100)	5 (127)
Power, hp (kw)	5 (3.7)	6.5 (4.8)
Displacement, cu in (cc)	4.48 (74)	5.71 (93.6)
Power/weight ratio, hp/lbs (kw/kg)	.24 (.39)	.26 (.44)
Fuel capacity, qt (l)	.95 (0.9)	1.1 (1)
Sound power level lwa, db(a)	115	115
Sound pressure level, db(a)	101	102
Vibrations front handle equivalent, m/s <sup>2</sup>	2.1	3.9 / 3.3
Vibrations rear handle equivalent, m/s <sup>2</sup>	2.3	4.2 / 4.3
Weight, without fuel and cutting equipment, lbs (kg)	22 (10)	24.2 (11)

Features		
X-torq®, air-cooled 2-stroke engine	Yes	Yes
Active air filtration™	Yes	Yes
Smartcarb™	Yes	Yes
Durastarter™	Yes	Yes
Easystart™	Yes	Yes
Reversible cutting arm	Yes	Yes
Fuel indicator in the tank	Yes	Yes
Easy-adjust blade guard	Yes	Yes
Replaceable arbor bushing	Yes	Yes



# Rail Power Cutters

## Applications

- Cuts rails in maintenance work on train, tram and underground rail systems.

## Benefits

- Equipped with double attachment mountings to allow cutting from both directions.
- Fast, stable mounting of the attachment onto the track also helps ensure straight cuts.



1 YEAR  
WARRANTY

POWER CUTTERS

Power Cutter Models	K 1270 Rail
Part No. (blade not included)	967982501

## Technical Specifications

Blade, in (mm)	16 (400)
Cutting depth, in (mm)	6 (152)
Power, hp (kw)	7.9 (4.8)
Displacement, cu in (cc)	7.25 (119)
Power/weight ratio, hp/lbs (kw/kg)	.17 (.27)
Fuel capacity, qt (l)	1.3 (1.2)
Sound power level lwa, db(a)	118
Sound pressure level, db(a)	102
Vibrations front handle equivalent, m/s <sup>2</sup>	5.1
Vibrations rear handle equivalent, m/s <sup>2</sup>	5.2
Weight, without fuel and cutting equipment, lbs (kg)	47 (21.2)

## Features

X-torq®, air-cooled 2-stroke engine	Yes
Active air filtration™	Yes
Smartcarb™	Yes
Easystart™	Yes
Easy-adjust blade guard	Yes
Replaceable arbor bushing	Yes

# Power Packs for Power Cutters

## Applications

- PP 518 (gas-powered) and PP 325 E (electric-powered) are capable of running hydraulic products like our DM 406 H drill motor, K 3600 MK II and K 2500 power cutters.

## Benefits

- PP 518 features a fuel-saving automatic power-on-demand, which is adjustable for different equipment and hose lengths. It can be switched off when constant power is desired.
- PP 325 E is mounted on a cart for easy mobility and its compact size makes it perfect for tight spaces.
- SoftStart™ provides easy startups, even at low temperatures when the oil is thick. (PP 325 E)



Power Pack Models	PP 518	PP 325 E
Part No.	967153602	965156406

## Technical Specifications

Engine	Gas twin cylinder OHV, aircooled, electric start	NA
Power, hp (kW)/engine manufacturer	18 (13.5) Briggs & Stratton	NA
Pressure, psi (bar)	2,000 (140)	2,000 (140)
Flow, gpm (lpm)	5, 8, 10 (20, 30, 40)	10 (40)
Weight (with oil), lbs (kg)	298 (135)	205 (93)
Hose set weight (with oil), lbs (kg)	22 (10)	NA
Hose set (2 hoses included as standard)	½"(13cm) x 25'(7.5m)	NA
Hydraulic connections	Flat faced couplers	Flat faced couplers
Hydraulic oil capacity, gal (l)	4 (15)	NA
Fuel capacity, gal (l)	3 (11.4)	NA
Dimensions (L x W x H), in (mm)	35 x 21 x 29 (89 x 53 x 74)	NA
Motor	NA	Electric
Specifications	NA	480v, 16amp, 60Hz, 3PH
Output, hp (kW)	NA	12.5 (9)
Hose set (3 hoses included as standard)	NA	0.5" (13cm) x 26' (8m)
Maximum input, gpm (lpm)	NA	NA
Maximum input pressure, psi (bar)	NA	NA
Flow rates, gpm (lpm)	NA	NA
Maximum output pressure, psi (bar)	NA	NA

# How to Control Dust while Cutting



POWER CUTTERS

Wet Applications	W-Line	Water Supply
<b>Wet Power Cutting</b>		
K 535i	+	WT 15 / PWT 15 / WT2GO
K 770	+	WT 15 / PWT 15 / WT2GO / KV K 770+
K 970	+	WT 15 / PWT 15 / KV K 970 / WT2GO / KV 1270+
K 1270	+	WT 15 / PWT 15 / KV K 970 / WT2GO / KV 1270+
K 4000	+	WT 15 / PWT 15 / WT2GO
K 7000	+	WT 15 / PWT 15 / WT2GO

+ Attached to machine

Dry Applications	S-Line	A-Line	
<b>Dry Power Cutting</b>	S 26	A 2000	A 600
K 770 Vac	+		
K 3000/K 4000	VA+		

+ Attached to machine VA-Vac Attachment

# Power Cutter Oil & Fuel

## OilGuard - Premium 2-Stroke Engine Oil

### Applications

OilGuard is a synthetic blend designed for power cutters and any other 2-cycle equipment used in tough, dirty conditions. OilGuard oil lowers engine operating temperatures and reduces smoke. It eliminates piston and cylinder failures caused by lack of lubrication.



Description	Part Number
1 case of 48, 2.6 oz bottles - 1 gal. mix (126/pallet)	504067201
1 case of 48, 6.4 oz bottles - 2-½ gal mix (78/pallet)	504067301 (US Customer Only)
1 case of 24, 12.8 oz bottles - 5 gal mix (90/pallet)	504067401 (US Customer Only)
1 case of 4, 1 gal bottles - 50 gal mix (60/pallet)	504067501 (US Customer Only)

1-9 cases - standard discount applies. | 10-49 cases - receive an additional 5% off. | 50+ cases - receive an additional 10% off. | Pallet quantities - receive freight prepaid.

## Pre-Mixed Fuel 2-Stroke Engine

### Applications

High Octane (95) fuel mixed with Husqvarna's best synthetic oil blend. There is no need for mixing or measuring. The fuel protects fuel systems, saves carburetors and extends equipment life because it does not contain ethanol. Extremely stable and a long shelf life.

Available in bulk sizes of 1/5/55 gallons! Ask your Husqvarna representative for more details.



Description	Part Number
1 case of 6, 1 quart cans	581158701*

\*Minimum purchase 2 cases. | Pallet quantities of 132 cases receive freight prepaid.

## Power Cutter Service Kits

Service Kits		K 770	K 970	K 1270	K 760 CNB
K 770 12"/14"	599156501	X			
K 970 14"	599156504		X		
K 970 16"	599156505		X		
K 1270 14"/16"	599156503			X	
K 760 Cut-N-Break	599156502				X



K 770 12"



K 770 14"



K 970 14"



K 970 16"



K 760 Cut-N-Break



# Water Tanks

## Features & Benefits

- The WT 15 is a battery-powered pressurized water tank that provides 45 minutes of cutting time. Works with all Husqvarna wet cutting equipment.
- A compact and easy-to-use 4 gallon water tank that helps you work efficiently. It has an electric pump, so there's no manual pumping required. The WT 15 is battery-powered with an 18.5 V Gardena Li-Ion accumulator system.



Water Tank Model	WT 15	PWT 15
Part No.	966708302	506326302
Water tank capacity, gal (L)	3.96 (15)	4 (15)
Battery type, Lithium-Ion	18 V/1.6 AH	-
Battery capacity	2 hrs.	-
Charger	18 V/600 mA	-
External power source	12/24 V, min 1.5A	-

Accessories	WT 15	PWT 15
WT 15 Lithium-Ion battery	505143101	X

## Features & Benefits

- No pump which means greater reliability.
- Lightweight and easy to carry around.
- Two carrying positions for easy transportation.
- No batteries or complicated electronics to maintain.
- Continuous water supply: 3.65 gal (13.8 L) tank can continuously supply water for 10-25 mins (depending on water value settings).



Water Tank Model	WT2G0
Part No.	598742401
Water tank capacity, gal (L)	3.65 (13.8)
Weight (dry), lbs (kgs)	12.6 (5.7)
Weight (full), lbs (kgs)	43 (19.5)
Continuous output pressure, PSI	7-10
Continuous output run time, mins	10-25

# Gas Power Cutter Accessories & Spare Parts

POWER CUTTERS

Accessories		K 770	K 970	K 1270
KV 7 two-wheel cart with water tank	587768401	X		
KV 9/12 two-wheel cart with water tank	587768402		X	X
Transport box	506310802	X	X	X
Water hose, 30'	531031529	X	X	X
Water tank, WT 15	966708302	X	X	X
Water tank, PWT 15	506326302	X	X	X
Water tank, WT2G0	598742401	X	X	X
Wheel Kit	589334301	X	X	X
Spare Parts		K 770	K 970	K 1270
Arbor bushing, replaceable 7/8"	506379622	X	X	X
Arbor bushing, reversible 20mm/1"	578398201	X	X	X
Belt (Poly-V) 12", 14" K 770	544908406	X		
Belt (Poly-V) 14", K 970/K 960	544908403		X	
Belt (Poly-V) 16", K 970/K 960	544908404		X	
Belt (Poly-V) 14", 16" K 1270/K 1260/K 1250	544976301			X
Belt (4PK 870) 14", K 970 II	544976304		X	
Belt (4PK 907) 16", K 970 II	544976305		X	
Complete starter assembly, K 770 & K 770 CnB	584886804	X		
Complete starter assembly, K 970	574507313		X	
Coupler, water hose	503266003	X	X	X
Filter, air K 970, K1270/K 1260	510244103		X	X
Filter, air with spill (cage) K 770/760/750	574362302	X		
Filter, fuel, with weight	506264111	X	X	X
Filter, metal cutting air K 970, K1270/K 1260 / Rail	510244105		X	X
Fuel tank cap assembly	506255906	X	X	X
Starter cord	506335615	X	X	X
Starter cord, bulk reel (165')	506335650	X	X	X
Starter assembly, complete K1270/K 1260/K 1250	506275509			X
Spark plug	503235109	X	X	X
Wet kit, magnesium guard	581476212	X		
Wrench, combination (Torx)	506382601	X	X	X

# Deep Cutting Gas Power Cutter Accessories & Spare Parts

Accessories		K 760 Cut-N-Break	K 970 Ring	K 970 Chain
Cut-n-Break tool	544178003	X		
Pro45 Kit, K 970 Chain*	588679701			X
Rim sprocket 3/8 pitch	506334201			X
Rim sprocket .444 pitch / Pro45	588147901			X
Transport box, K 970/K 960/K 3600	575422801		X	
Transport box, K 970/K 960 Chain	575465101			X
Water hose, 30'	531031529	X	X	X
14" bar	506346214			X
12" bar Pro45 .444 pitch	587781401			X
16" bar Pro45 .444 pitch	587781402			X
Spare Parts		K 760 Cut-N-Break	K 970 Ring	K 970 Chain
Belt, K 760 CnB	506372702	X		
Belt (Poly-V)	544908401		X	
Blade bolt kit	501008806	X		
Complete starter assembly, K 770 & K 770 CnB	584886804	X		
Complete starter assembly, K 970	574507313		X	X
Coupler, water hose	503266003	X	X	X
Drive disc (blade)	506178304		X	
Filter, air with spill (cage) K 770/760/750	574362302	X		
Filter, fuel, with weight	506264111	X	X	X
Filter, polyester air (K 970 Chain & Ring)	510244106		X	X
Fuel tank cap assembly	506255906	X	X	X
Hose kit/valve handle	505095501		X	
Knob with seal	506382202		X	
Nose bearing cage kit	504142501	X		
Nose bearing tool	544178101	X		
Roller, guide	506352005		X	
Roller, support	506352103		X	
Spark plug	503235109	X	X	X
Starter cord	506335615	X	X	X
Starter cord, bulk reel (165')	506335650	X	X	X
Wrench, combination (Torx)	506382601	X	X	X

# Battery Power Cutter Accessories & Spare Parts

POWER CUTTERS

Accessories		K 535i
Dust reducer unit, K535i XP	594077801	X
Batteries & Spare Parts		K 535i
BLi 100	967963902	•
BLi 200	967964102	X
BLi 300	967964302	X
BLi 550X	967964502	X
BLi 950X	967964602	X
Battery bag	585371801	X
Battery, box	585428801	X
Battery, insulated bag	585371801	X
QC80	967964702	•
QC330	967964903	X
QC500	967965003	X
QC80F 12V	967964802	X

X = Accessories/Spare Parts • = Works but not recommended X\* = Standard Accessory



BLi 100



BLi 200



BLi 300



BLi 550X/BLi 950X



QC 330



QC 500

# Electric Power Cutter Accessories & Spare Parts

Accessories		K 4000 Wet	K 4000 CnB
Cut-n-Break tool	544178003		X
S 26	967663901	X	
Dust reducer unit, K 4000 Vac	523095001	X	
Transport box, K 4000	505399523	X	
Water tank, WT 15	966708302	X	
Water tank, PWT 15	506326302	X	
Water tank, WT2GO	598742401	X	
Spare Parts		K 4000 Wet	K 4000 CnB
Belt, K 4000 CnB	506372720		X
Blade bolt kit	501008806		X
Brush, carbon	589911202	X	
Brush, pop-up kit (2 brushes)	581086804	X	
Cord assembly with plug, GFI, wet	594005603	X	X
Cord protection at handle	575811001	X	X
Elgard circuit protection, 110/120, wet	577010105	X	
Spray guard	577935301	X	X
Trigger switch	531031883		X
Wrench, combination	501691702	X	X



## Prime Power Cutter Accessories & Spare Parts

Accessories		K 7000	K 7000 Ring	K 7000 Chain
12" bar Pro45 .444 pitch	587781401			X
16" bar Pro45 .444 pitch	587781402			X
Rim sprocket .444 pitch/Pro45	588147901			X
Wheel Kit	589334301	X		
Spare Parts		K 7000	K 7000 Ring	K 7000 Chain
Belt	544908405		X	
Belt	544976306	X		
Knob with seal	506382202		X	
Roller, support	506352103		X	
Roller, guide	506352005		X	
Tool Kit (combo, 19mm, 6 mm, 5 mm, 4 mm)	506363802		X	

## Hydraulic Power Cutter Accessories & Spare Parts

Accessories		K 3600 MK II	K 2500
Transport box, K 970/K 960/K 3600	575422801	X	X
Water hose, 30'	531031529	X	X
Spare Parts		K 3600 MK II	K 2500
Drive disc (blade)	506178304	X	
Knob with seal	506382202	X	
Roller, guide	506352005	X	
Roller, support	506352103	X	
Tool kit (Combo, 19mm, 6mm, 5mm, 4mm)	506363802	X	

## Specialty Power Cutter Accessories & Spare Parts

Accessories		K 770 Rescue	K 970 Rescue	K 1270 Rail
Transport box	506310802	X	X	
Transport box, K 1270 Rail	575465301			X
RA 10	506226611			X
RA 10 S (Wide Rail)	506226612			X
Spare Parts		K 770 Rescue	K 970 Rescue	K 1270 Rail
For K 770 spare parts	See Pg. 67			
For K 970 spare parts	See Pg. 67			
For K 1270 spare parts	See Pg. 67			
Belt Rail (Poly-V) 16" K 1270 R/K 1260 R/K 1250 R	544976302			X
Filter, metal cutting air K 970, K1270/K 1260 / Rail	510244105			X
Starter grip, rescue	506297502	X		
Strap bracket, rear handle K 760	506302504	X		
Strap bracket rear handle, K 970	588731402		X	
Shoulder strap	586456001	X	X	

## Power Pack Accessories & Spare Parts

Accessories		PP 518	PP 325 E
Hydraulic hose ½" x 26' (8m), 2 hose set & fitted water hose	531115170		X
Hydraulic hose ½" x 25' (7.6m), 2 hose set	510202306	X	
Hydraulic hose 5/8" x 25' (7.6m), 2 hose set	510202308	X	
Hydraulic hose 5/8" x 50' (15.2m), 2 hose set	510202310	X	

# Power Cutter Diamond Blades

POWER CUTTERS



MATERIAL	H10	H18	H15	H13
GRANITE	-	-	● ●	● ● ●
MARBLE	-	-	-	● ●
CURED CONCRETE	-	● ● ●	● ● ●	● ● ●
REINFORCED CONCRETE	-	● ●	● ● ●	● ● ●
BRICK	-	● ● ●	● ● ●	● ●
ROOF TILE, CLAY	-	● ● ●	● ● ●	● ●
ABRASIVE MATERIAL/BLOCK	● ● ●	● ● ●	●	-
GREEN CONCRETE	● ● ●	● ●	-	-
ASPHALT	● ● ●	● ●	-	-
STEEL BAR	-	-	●	●

●●●= Optimal ●●= Good ●= Acceptable - = Not recommended

GOLD

SILVER

BRONZE

MATERIAL	NXS	VARI-CUT™ PLUS	VARI-CUT™	VARI-CUT™ TURBO	FR3	DI5	QH5	VH5	VH10
CERAMIC TILE	●	-	●	●	-	●	●	●	-
GRANITE	●●	-	●●	●●●	-	●	●●	●●	-
MARBLE	-	-	●●	●●●	-	-	●●●	●	-
CURED CONCRETE	●●	●●●	●●●	●●●	-	●●	●●●	●●●	-
REINFORCED CONCRETE	●●	●●	●●●	●●●	-	●	●●●	●●	-
BRICK	●●	●●●	●●●	●●●	-	●●	●●●	●●●	-
ROOF TILE, CLAY	●●	●●●	●●●	●●●	-	●●	●●●	●●●	-
ABRASIVE MATERIAL/BLOCK	●	●●●	●●	●	-	●	●●●	●	●●●
GREEN CONCRETE	-	●●●	●	●	-	-	-	-	●●●
ASPHALT	-	●●	●	-	-	-	-	-	●●●
STEEL BAR	●●●	-	-	-	●●●	●●●	-	-	-
DUCTILE IRON	●●●	-	-	-	●●●	●●●	-	-	-

●●●= Optimal ●●= Good ●= Acceptable - = Not recommended

### Cut-N-Break Application Chart

MATERIAL	EL10CNB	EL35CNB	EL70CNB
STONE	●●	●●	-
CONCRETE, HARD	●●●	●●●	-
CONCRETE, MEDIUM	●●●	●●●	●
CONCRETE, SOFT	●●	●●●	●●
BUILDING BRICK	●●●	●●●	-
ABRASIVE BUILDING BRICK	●	●	●●●

●●●= Optimal ●●= Good ●= Acceptable - = Not recommended

### Ringsaw Application Chart

MATERIAL	R1410/R1420	VARI-RING R10	VARI-RING R20	TACTI-RING R10	DI RING
STONE	●●●	●●●	●	●	-
CONCRETE, HARD	●●●	●●●	●●	●●	-
CONCRETE, MEDIUM	●●●	●●	●●●	●●●	-
CONCRETE, SOFT	●●	●	●●	●●	-
BUILDING BRICK	●	●	●	●	-
ABRASIVE BUILDING BRICK	-	-	●	-	-
DUCTILE IRON	-	-	-	-	●●●

●●●= Optimal ●●= Good ●= Acceptable - = Not recommended

### Diamond Chain Application Chart

MATERIAL	PR045	PXC45	ELC45	SLC45
STONE	●●	●●	●●	●
CONCRETE, HARD	●●●	●●●	●●	●●
CONCRETE, MEDIUM	●●●	●●●	●●●	●●●
CONCRETE, SOFT	●●●	●●●	●●●	●●
BRICK	●●●	●●●	●●●	●
ABRASIVE BLOCK	-	-	-	●

●●●= Optimal ●●= Good ●= Acceptable - = Not recommended

### Abrasive Application Chart

MATERIAL	EHS
CONCRETE	●●●
GREEN CONCRETE	●●●
MASONRY	●●●
METAL/STEEL	●●●
DUCTILE/CAST IRON	●●●

●●●= Optimal ●●= Good ●= Acceptable - = Not recommended

# Power Cutter Diamond Blades

## Elite-Cut HI Series

GENERAL PURPOSE, ABRASIVE MATERIAL BLADES, 2-15 HP

POWER CUTTERS

- HI3: highly reinforced concrete
- HI5: reinforced concrete, brick

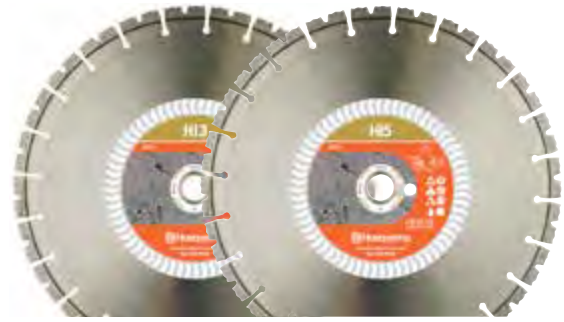

### Elite-Cut HI Series | Dry or Wet Cutting | Laser Welded

Sizes - Inches (mm)	HI3 Part Number	HI5 Part Number
12 (305) x .125 x 1 DP - 20 mm B	587081801	542774540
14 (350) x .125 x 1 DP - 20 mm B	587081901	542774541
16 (400) x .125 x 1 DP - 20 mm B	582393501	-
16 (400) x .140 x 1 DP - 20 mm B	587082001	542774542
16 (400) x .165 x 1 DP - 20 mm B	582669101	-
16 (400) x .235 x 1 DP - 20 mm B	582663801	-

Total segment height HI3, HI5, HI8: .475" (.375" diamond depth, .100" segment base). Total segment height HI10: .400" (.300" diamond depth, .100" segment base).

## Elite-Cut HI Series

GENERAL PURPOSE, ABRASIVE MATERIAL BLADES, 2-15 HP

- HI8: block, soft brick, concrete pavers
- HI10: asphalt, green concrete



### Elite-Cut HI Series | Dry or Wet Cutting | Laser Welded

Sizes - Inches (mm)	HI8 Part Number	HI10 Part Number
12 (305) x .125 x 1 DP - 20 mm B	542776503	542776406
14 (350) x .125 x 1 DP - 20 mm B	542776504	542776404
16 (400) x .125 x 1 DP - 20 mm B	-	-
16 (400) x .140 x 1 DP - 20 mm B	542776505	542776409

Total segment height HI3, HI5, HI8: .475" (.375" diamond depth, .100" segment base). Total segment height HI10: .400" (.300" diamond depth, .100" segment base).



## Power Cutter Diamond Blades

### Vari-Cut™ Series

GENERAL PURPOSE, ABRASIVE MATERIAL  
BLADES, 2-15 HP

- Vari-Cut: reinforced concrete, brick, block.
- Vari-Cut Plus: reinforced concrete, brick, block, green concrete & asphalt.
- Vari-Cut Turbo: highly reinforced concrete, brick.

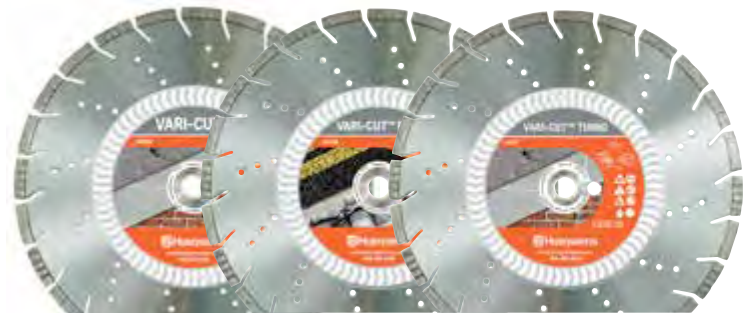

Vari-Cut Series | Dry or Wet Cutting | Laser Welded

Sizes - Inches (mm)	Vari-Cut Part No.	Vari-Cut Plus Part No.	Vari-Cut Turbo Part No.
12 (305) x .125 x 1 DP - 20 mm B	542751358	-	-
14 (350) x .125 x 1 DP - 20 mm B	542751359	585580801	586107801
16 (400) x .125 x 1 DP - 20 mm B	542751360	585580802	587905905

Total segment height: .400" (.300" diamond depth, .100" segment base).

## Premium Cutting Package



# Power Cutter Diamond Blades

## QH5

### GENERAL PURPOSE BLADES, 2-15 HP

- QH5: reinforced concrete, brick & block.



#### QH5 | Dry or Wet Cutting | Diffusion Bond

Sizes - Inches (mm)	Part Number
12 (305) x .118 x 1 DP - 20 mm B	542773661
14 (350) x .118 x 1 DP - 20 mm B	542773481
16 (400) x .118 x 1 DP - 20 mm B	501635601
14 (350) x .118 x 1 DP - 20 mm B (5 pack)	542773811
14 (350) x .118 x 1 DP - 20 mm B (10 pack)	542773670

Total segment height is .500" (.400" diamond depth, .100" segment base).

## Tacti-Cut VH Series

### GENERAL PURPOSE BLADES, 2-15 HP

- VH3: highly reinforced concrete.
- VH5: reinforced concrete, brick.
- VH10: block, soft brick, concrete pavers, green concrete.



#### Tacti-Cut Series | Dry or Wet Cutting | Diffusion Bond

Sizes - Inches (mm)	VH3 Part No.	VH5 Part No.	VH10 Part No.
12 (305) x .118 x 1 DP - 20 mm B	-	542774462	-
14 (350) x .118 x 1 DP - 20 mm B	589487901	542774463	-
14 (350) x .125 x 1 DP - 20 mm B	-	-	542777195
14 (350) x .125 x 1 DP - 20 mm B (5 pack)	-	-	542773482
14 (350) x .118 x 1 DP - 20 mm B (5 pack)	-	542777987	-
12 (305) x .118 x 1 DP - 20 mm B (10 pac)	-	542773240	-
14 (350) x .118 x 1 DP - 20 mm B (10 pack)	-	542773241	-

Total segment height: .450" (.350" diamond depth, .100" segment base).

# Power Cutter Diamond Blades

## NXS

### METAL CUTTING, FIRE RESCUE BLADES

- Thicker, electroplated core with cooling holes for protection during deep cutting.
- NXS: metal, concrete, stone, rebar, brick, block.



#### NXS | Dry or Wet Cutting | Laser Welded

Sizes - Inches (mm)	Part Number
12 (305) x .125 x 1 DP - 20 mm B	542751722
14 (350) x .125 x 1 DP - 20 mm B	542751723
16 (400) x .140 x 1 DP - 20 mm B	542751724

Total segment height is .200"

## FR3

### METAL CUTTING, FIRE RESCUE BLADES

- Recommended when free cutting of any material is a critical requirement including steel.
- FR3: metal, concrete, stone, rebar, brick, block.



#### FR3 | Dry or Wet Cutting | Laser Welded

Sizes - Inches (mm)	Part Number
12 (305) x .140 x 1 DP - 20 mm B	542777197
14 (350) x .140 x 1 DP - 20 mm B	542777184
16 (400) x .140 x 1 DP - 20 mm B	542773051

## DI5

### DUCTILE IRON BLADES

- Lasts as long as 75 husqvarna abrasive blades.
- Electroplating core.



#### DI5 | Dry or Wet Cutting | Laser Welded

Sizes - Inches (mm)	Part Number
12 (305) x .125 x 1 DP - 20 mm B	542776407
14 (350) x .125 x 1 DP - 20 mm B	542776408
<b>Steel brushing for high-speed diamond &amp; abrasive blades</b>	
1-20 mm B	542751283
1- 7/8" B	542751284

Total segment height is .200"

# Power Cutter Diamond Blades

## Vari-Cut FR3 Battery Blade

### METAL CUTTING BLADE

- FR3: free cutting in hard metals, PVC, tile backer boards, steel & roofing tiles.



FR3 | Wet Cutting | Laser Welded

Sizes - Inches (mm)

9 (229)

Total segment height is .200"

Part Number

574853801

## Tacti-Cut S35S Battery Blade

### GENERAL PURPOSE BLADE

- S35S: fast, smooth cutting in stone, tile, brick, concrete & masonry materials. (silent core)



S35S | Dry or Wet Cutting | Diffusion Bond

Sizes - Inches (mm)

9 (229) Abrasive

Total segment height is .200"

Part Number

596520301

## Tacti-Cut Metal Battery Blade

### METAL ABRASIVE BLADE

- Tacti-Cut Metal: general purpose metal cutting.



Tacti-Cut Metal | Dry Cutting

Sizes - Inches (mm)

9 (229)

Total segment height is .200"

Part Number

596826701



# Power Cutter Diamond Blades

## Elite-Ring Series Blades

HARD CONCRETE, GENERAL PURPOSE, ABRASIVE MATERIAL BLADES

- R1410: reinforced concrete.
- R1420: stone, cured concrete, green concrete, brick.



### Elite-Ring | Wet Cutting | Laser Welded

Sizes - Inches (mm)	R1410 Part Number	R1420 Part Number
14 (350) x .165	589648101	587344701
14 (350) x .235	589648001	-
17 (432) x .165	593727701	593727901
17 (432) x .235	593727702	-

Total segment height is .450" (.350" diamond depth, .100" segment base.)

## Vari-Ring Series Blades

HARD CONCRETE, GENERAL PURPOSE, ABRASIVE MATERIAL BLADES

- R10: available as .220" wide ring saw blade for chainsaw pre-cut.
- R20: general concrete, reinforced concrete. Available in .235" wide for chainsaw pre-cut.
- DI Ring: ductile iron, one layer of vacuum brazed diamonds.



### Vari-Ring | Wet Cutting | Laser Welded

Sizes - Inches (mm)	R10 Part Number	R20 Part Number	DI Ring Part Number
14 (350) x .165	531108058	531108059	574478702
14 (350) x .235	542767375	-	-
17 (432) x .165	-	-	593727601

Total segment height is .450" (.350" diamond depth, .100" segment base.)

## Tacti-Ring Series Blades

HARD CONCRETE, GENERAL PURPOSE, ABRASIVE MATERIAL BLADES

- R10: general concrete.



### Tacti-Ring | Wet Cutting | Laser Welded

Sizes - Inches (mm)	Part Number
14 (350) x .165	542767358

Total segment height is .200"

# Power Cutter Diamond Blades

## Diamond Chains

GENERAL PURPOSE, ABRASIVE MATERIAL



- PXC45: general purpose, granite, hard brick.
- ELC45: general purpose, lightly reinforced concrete, concrete pipes, other precast concrete.
- SLC45: general purpose, lightly reinforced concrete, concrete pipes, other precast concrete.
- PRO45: reinforced concrete, concrete pipe and precast. Designed for PRIME K 6500 Chainsaw.
- 16" chains cut 17" deep and 12" chains cut 13" deep.

### Diamond Chains | Wet Cutting | Laser Welded

Description - Size - Segment Width	Part Number
PXC45 14" (.220" wide)	590329801
ELC45 14" (.220" wide)	590329901
SLC45 14" (.220" wide)	590330101
PRO45 12" (.220" wide)	588150401
12" PRO45 bar	587781401
14" bar	506346214
PRO45 16" (.220" wide)	588150402
16" PRO45 bar	587781402

## Cut-N-Break Diamond Blade Sets

HARD CONCRETE, GENERAL PURPOSE, ABRASIVE MATERIAL



- EL10CnB: cured concrete with hard to medium-hard aggregate.
- EL35CnB: general purpose, river rock, granite, heavily reinforced concrete, mica, precast panels, marble, quartz, trap rock and flint rock.
- EL70CnB: concrete block, green concrete, limestone, lava rock, slate, shale, sandstone, very abrasive softer material.
- All Cut-N-Break blade sets have a depth of 16", for wet cutting only.

### Cut-N-Break Blade Sets | Wet Cutting | Laser Welded

Description	Part Number
EL10	597807901
EL35	597808001
EL70	597808301

Total segment height is .295"

## EHS High-Speed Abrasive

CONCRETE, MASONRY, METAL BLADES



- Red EHS: concrete, masonry.
- Blue EHS: metals.
- Green EHS: cast iron, ductile iron.
- Yellow EHS: XX
- List price is for one blade, must purchase in packaged quantities (10/box).

### Abrasive Blades | Wet Cutting | Laser Welded

Sizes - Inches (mm)	Red EHS Part No.	Blue EHS Part No.	Green EHS Part No.	Yellow EHS Part No.
12 (305) x 1/8 x 1	542751490	542751494	542751498	-
12 (305) x 1/8 x 20 mm	542751491	542751495	542751499	-
14 (350) x 1/8 x 1	542751492	542751496	542751500	542751520
14 (350) x 1/8 x 20 mm	542751493	542751497	598694101	-
16 (400) x 1/8 x 1	-	-	-	542751521





# BRING COMPACTION TO A WHOLE NEW LEVEL WITH HUSQVARNA'S PREMIER LINE UP

COMPACTION

Husqvarna's compaction equipment is developed for maximum productivity, performance and durability. Every little detail in your machine - from the ergonomic, vibration-damped handles to the hard, wear-resistant steel surface beating the ground - is designed to get the job done with maximum uptime and minimum service required. By designing the products for easy handling and reduced vibrations we help you stay concentrated and sharp the whole working day.



## Husqvarna LP 9505 Trench Compactor

Radio remote control technology enables the operator to choose the standing position that will produce the best end result. This provides better ergonomics and safer working conditions. The wide drums and low center of gravity deliver excellent stability to increase safety even further. Servicing is quick and easy with all service points clearly marked and easily accessible under the protective hoods.

## Range Overview

Husqvarna offers a complete range of compaction equipment for all soils and pavements, including tamping rammers, forward plate compactors for soil, forward plate compactors for soil & asphalt, reversible plate compactors, duplex roller and trench roller.

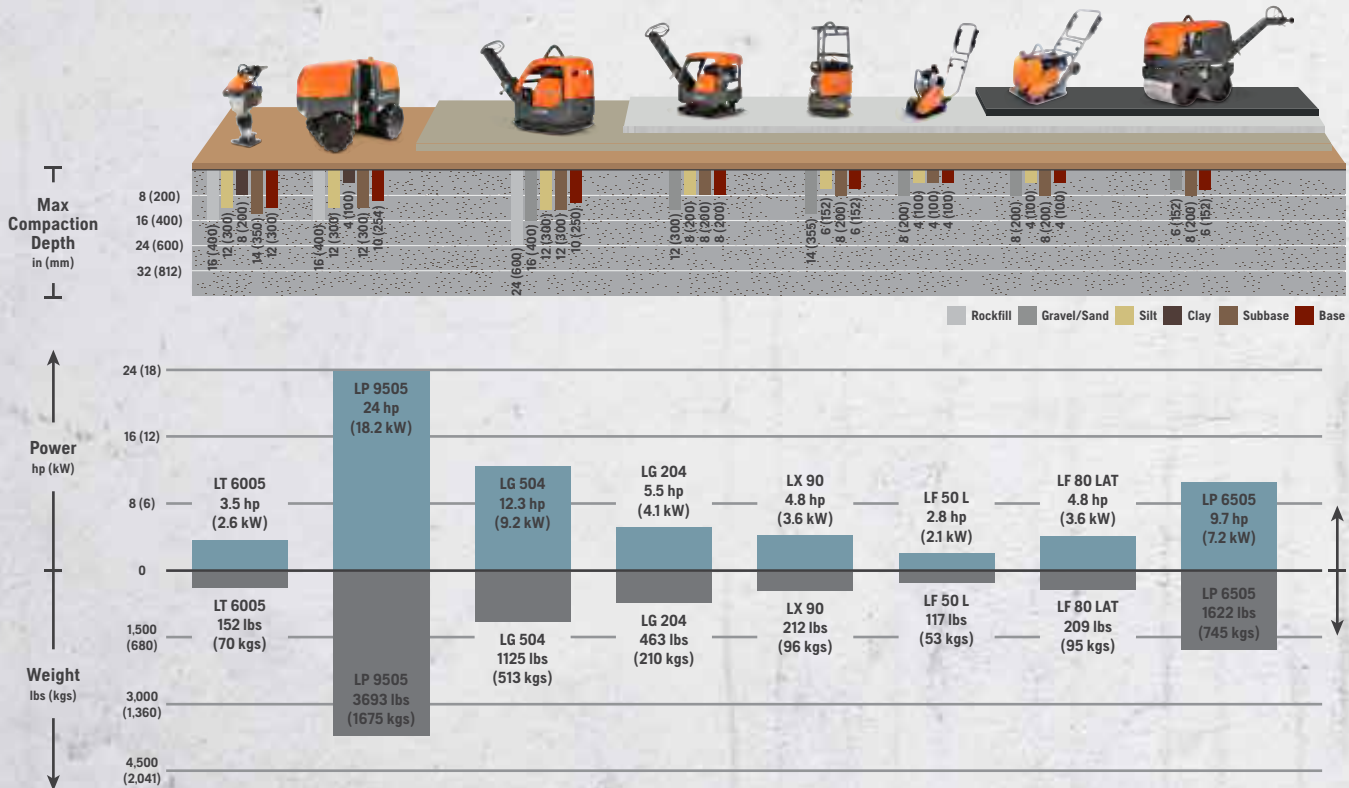





Our mid-size forward and reversible plate compactor family provides impressive traction, particularly on wet soil, due to high frequency, high centrifugal force and high amplitude. These models have an ergonomic design and easy access for service and maintenance. The compaction indicator helps you get it right the first time.

This range of compactors can handle both deep and medium-deep compaction of granular soils, and like all our forward and reversible plate compactors, they are an effective alternative and complement to rollers when compacting soil in confined areas.

High speed, machine balance and a vibration-damped handle contribute to easy handling, even on rough surfaces. These features combined with overall ergonomics, enable the user to work for longer periods more effectively, staying concentrated on the task at hand.

This range of forward and reversible plate compactors with lower operating mass are developed for smaller jobs and lighter materials, such as driveways and pathways, private house projects and narrow trenches. These machines are ideal when macadam beds are thinner and you need a compactor that can move around corners fast. The lower operating mass and narrower bottom plates mean these models are nimble and responsive. Low vibration levels in the handles make you effective.

Husqvarna LG 300 is equipped with a diesel engine that only creates hand/arm vibrations of 1.7 m/s<sup>2</sup>. This means you will be more efficient as you can work longer without being exposed to harmful vibration levels. Both petrol and diesel engines have low fuel consumption and low emissions. The heavy-duty steel frame helps protect engine and transmission.



# KNOWING YOUR SOIL AND SURFACE WILL HELP YOU CHOOSE THE BEST COMPACTION EQUIPMENT

Soil has been around for millions of years and is created by the force of nature. Here's how you'll manage to tame Mother Nature's upper crust.

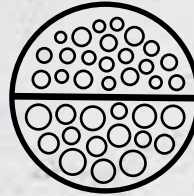

## GRAVEL - PUT ON THE PRESSURE

Cobbles and boulders need high compaction energy to achieve the necessary density and stability. It is especially important if the material is embedded in clay or silt that may liquefy when wet. Layer thickness should be at least three times thicker than maximum particle size.

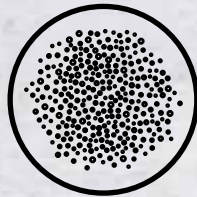

## SILT - NEEDS FORCE

Silt is not as cohesive as clay, but still needs proper water content for good compacting. The cohesive soils have the smallest particles of all soils. Silt particles are larger than in clay but they are still small enough to require high energy for deep compacting. A tamping rammer is the best choice for compacting silt.

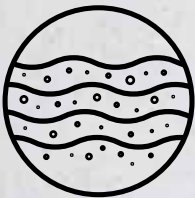

## CLAY - STICKS TOGETHER

Clay particles stick together and you need high impact force to get the air out. Proper moisture is important when compacting. Wet clay can be molded while dry clay becomes very hard and may crack under pressure. Husqvarna LT rammers are able to transmit the high pressures and shear forces necessary to compact clay at or below optimum water content.



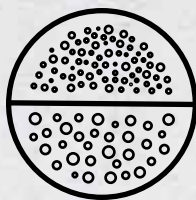

### SAND & GRAVEL - TAKE IT EASY

For sand and gravel you can achieve high-density compaction in either a dry or saturated state. The level of compaction depends more on grading than moisture. Too much compaction of sand and gravel is like beating a concrete wall with a sledgehammer. It can crush the material and reduce the load-bearing capacity. Depending on the thickness of the layer, a lighter forward plate or heavier reversible plate compactor is recommended.

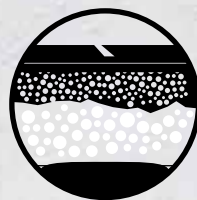

### ASPHALT - LEAVE NO MARKS

Compaction has a profound influence on asphalt performance. Compaction transforms the asphalt mix from a loose state to a compact surface that carries heavy loads. Efficiency of compaction depends heavily on the internal resistance of asphalt. Machines must be able to compact without leaving marks and water helps to create a smooth surface. Here, an asphalt plate compactor or a duplex roller is a safe choice.



# Tamping Rammers

## Applications

- Ideal for compacting clay and silt type soils.
- Perfect for trench and sewage systems, gardening and landscaping, compaction on backfill, foundations, patching and repair applications.

## Benefits

- Equipped with the purpose-built Honda GXR120 gas engine, designed specifically for rammers.
- Three fixed positions for the throttle control, stop (gas line fully closed), idle and full speed.
- Balanced design allows excellent traction and maneuverability.
- Easy access to all service points.



Compaction Model	LT 6005	LT 5005
Part No. (9" Plate)	967854501	967854601
Part No. (11" Plate)	967854502	-

## Technical Specifications

Operating weight, lbs (kgs)	149 (68)/152 (69)	136 (62)
Engine	Honda GXR120	Honda GXR120
Rated power, hp (kW)	3.5 (2.7)	3.5 (2.7)
Frequency, Hz	12	12
Speed, ft/min (m/min)	49-60 (15-18)	49-60 (15-18)
H/A vibration, standard handle, ft/s <sup>2</sup> (m/s <sup>2</sup> )	21 (6.4)	21 (6.4)
Sound power, guaranteed, dB(A)	92	92
Sound pressure at operators ears, dB(A)	106	106
Plate width, in (mm)	9 (230)/11 (280)	9 (230)
Plate length, in (mm)	13 (332)	13 (332)
Dimensions (L x W x H), in (mm)	28.5 x 13.5 x 42.7 (726 x 345 x 1,084)	28.5 x 13.5 x 40.4 (726 x 345 x 1,025)

COMPACTION APPLICATION

SOILS



# Forward Plate Compactors

## Applications

- Plate compactors specialize in compacting thin to medium layers of granular soil.

## Benefits

- Factory prepared for mounting a block paving kit to protect paving blocks from cracking.
- Patented, exclusive low vibration handle lowers vibration levels below 6.5 ft/s<sup>2</sup> (2 m/s<sup>2</sup>).



Compaction Model	LF 50 L	LX 90
Part No.	967854702	967897101

## Technical Specifications

Operating weight, lbs (kgs)	116 (53)	212 (96)
Engine	Honda GX120	Honda GX160
Rated power, hp (kW)	2.8 (2.1)	4.8 (3.6)
Frequency, Hz	95	-
Centrifugal force, lbf (kN)	1,888 (8.4)	3,597 (16)
Speed, ft/min (m/min)	79 (2.4)	72 (22)
H/A vibration, standard handle, ft/s <sup>2</sup> (m/s <sup>2</sup> )	6 (1.8)	20 (6.1)
Sound power, guaranteed, dB(A)	100	104
Sound pressure at operators ears, dB(A)	89	92
Plate width, in (mm)	12.6 (320)	17.7 (450)
Plate length, in (mm)	19.9 (505)	-
Dimensions (L x W x H), in (mm)	37 x 12.6 x 38 (940 x 320 x 965)	17.7 x 17.7 x 36.2 (450 x 450 x 920)

COMPACTION APPLICATION

SOILS



# Forward Plate Compactors

## Applications

- "LAT" plate compactors are designed for compacting asphalt and soil.

## Benefits

- Factory prepared for mounting a block paving kit to protect paving blocks from cracking.
- Patented, exclusive low vibration handle lowers vibration levels below 6.5 ft/s<sup>2</sup> (2 m/s<sup>2</sup>).
- LAT's feature a removable water tank with an oversized, secure cap to make refills fast, easy and less frequent.



Compaction Model	LF 100 LAT	LF 80 LAT
Part No.	967855102	967855002

## Technical Specifications

Operating weight, lbs (kgs)	236 (107)	181 (82)
Engine	Honda GX160	Honda GX160
Rated power, hp (kW)	4.8 (3.6)	4.8 (3.6)
Frequency, Hz	95	95
Centrifugal force, lbf (kN)	3,754 (16.7)	4,361 (19.4)
Speed, ft/min (m/min)	82 (25)	108 (33)
H/A vibration, standard handle, ft/s <sup>2</sup> (m/s <sup>2</sup> )	4.2 (1.3)	4.1 (1.2)
Sound power, guaranteed, dB(A)	104	103
Sound pressure at operators ears, dB(A)	93	91
Plate width, in (mm)	19.7 (500)	16.5 (420)
Plate length, in (mm)	23.4 (595)	22.4 (570)
Dimensions (L x W x H), in (mm)	37.8 x 19.7 x 39.2 (960 x 500 x 995)	37.8 x 16.5 x 39.2 (960 x 420 x 995)

# Forward Plate Compactors

## Applications

- "LAT" plate compactors are designed for compacting asphalt and soil.

## Benefits

- Factory prepared for mounting a block paving kit to protect paving blocks from cracking.
- Patented, exclusive low vibration handle lowers vibration levels below  $6.5 \text{ ft/s}^2$  ( $2 \text{ m/s}^2$ ).
- LAT's feature a removable water tank with an oversized, secure cap to make refills fast, easy and less frequent.



Compaction Model	LF 75 LAT - 20"	LF 75 LAT - 17"	LF 60 LAT
Part No.	967854902	967854901	967854802

## Technical Specifications

Operating weight, lbs (kgs)	209 (95)	203 (92)	147 (67)
Engine	Honda GX160	Honda GX160	Honda GX120
Rated power, hp (kW)	4.8 (3.6)	4.8 (3.6)	2.8 (2.1)
Frequency, Hz	95	95	95
Centrifugal force, lbf (kN)	3,282 (14.6)	3,282 (14.6)	2,338 (10.4)
Speed, ft/min (m/min)	79 (24)	89 (27)	82 (25)
H/A vibration, standard handle, $\text{ft/s}^2$ ( $\text{m/s}^2$ )	4 (1.2)	4 (1.2)	6.5 (1.9)
Sound power, guaranteed, dB(A)	104	104	100
Sound pressure at operators ears, dB(A)	91	91	88
Plate width, in (mm)	19.7 (500)	16.5 (420)	13.8 (350)
Plate length, in (mm)	22.4 (570)	22.4 (570)	21.5 (545)
Dimensions (L x W x H), in (mm)	37.8 x 19.7 x 39.2 (960 x 500 x 995)	37.8 x 16.5 x 39.2 (960 x 420 x 995)	38.8 x 13.8 x 38.1 (986 x 350 x 968)

COMPACTION APPLICATION

SOIL | ASPHALT

# Reversible Plate Compactors - Large

## Applications

- Designed for both deep and medium-deep compaction of granular soils.
- Effective alternative and complement to rollers when compacting in tight areas.

## Benefits

- Forward/reverse lever and fixed handle grip makes handling easy on all surfaces.
- The bottom plates are made from Hardox 400, an extremely robust & wear-resistant steel.
- An optional compaction indicator tells you when the ground is ideally compacted.



Compaction Model	LG 504 - 34"	LG 504 - 28"	LG 504 - 22"	LG 400 - DIESEL	LG 400 - GAS
Part No.	967855503	967855502	967855501	967855402	967855401
Part No. (Compaction indicator)	967855515	967855514	967855513	967896402	-

## Technical Specifications

Operating weight, lbs (kgs)	1,124 (510)	1,100 (499)	1,036 (470)	961 (43)	877 (398)
Starter type	Electric start	Electric start	Electric start	Electric start	Manual start
Engine	Hatz 1D81Z	Hatz 1D81Z	Hatz 1D81Z	Kohler 15LD440	Honda GX390
Fuel	Diesel EPA	Diesel EPA	Diesel EPA	Diesel EPA	Gasoline
Rated power, hp (kW)	12.3 (9.1)	12.3 (9.1)	12.3 (9.1)	8.4 (6.2)	11.3 (8.3)
Frequency, Hz	69	69	69	60	60
Amplitude, in (mm)	0.094 (2.4)	0.094 (2.4)	0.094 (2.4)	0.071 (1.8)	0.071 (1.8)
Centrifugal force, lbf (kN)	14,612 (65)	14,612 (65)	14,612 (65)	11,670 (52)	11,670 (52)
Speed, ft/min (m/min)	98 (30)	98 (30)	98 (30)	82 (25)	82 (25)
H/A vibration, standard handle, ft/s <sup>2</sup> (m/s <sup>2</sup> )	8.2 (2.5)	8.2 (2.5)	8.2 (2.5)	7 (2.1)	8.2 (2.5)
Sound power, guaranteed, dB(A)	109	109	109	108	108
Sound pressure at operators ears, dB(A)	96	96	96	93	95
Plate width, in (mm)	33.5 (850)	27.6 (700)	21.7 (550)	25.6 (650)	25.6 (650)
Plate length, in (mm)	35.4 (900)	35.4 (900)	35.4 (900)	38.1 (967)	38.1 (967)
Dimensions (L x W x H), in (mm)	65.7 x 33.5 x 46.9 (1,670 x 850 x 1,190)	65.7 x 33.5 x 46.9 (1,670 x 850 x 1,190)	65.7 x 33.5 x 46.9 (1,670 x 850 x 1,190)	66.5 x 25.6 x 45.3 (1,690 x 650 x 1,150)	66.5 x 25.6 x 45.3 (1,690 x 650 x 1,150)

COMPACTION APPLICATION

GRAVEL | ROCKS

# Reversible Plate Compactors - Small

## Applications

- Lower operating mass for smaller jobs and lighter materials.
- Perfect for driveway and pathway applications, residential projects and narrow trenches.

## Benefits

- Forward/reverse lever and fixed handle grip makes handling easy on all surfaces.
- The bottom plates are made from Hardox 400, an extremely robust & wear-resistant steel.



Compaction Model	LG 300 - DIESEL	LG 300 - 24"	LG 300 - 20"	LG 204	LG 164
Part No.	967855303	967855302	967855301	967855201	967855601

## Technical Specifications

Operating weight, lbs (kgs)	676 (307)	595 (270)	584 (265)	465 (211)	346 (157)
Starter type	Electric start	Manual start	Manual start	Manual start	Manual start
Engine	Hatz 1B30	Honda GX270	Honda GX270	Honda GX200	Honda GX160
Fuel	Diesel EPA	Gasoline	Gasoline	Gasoline	Gasoline
Rated power, hp (kW)	6.4 (4.7)	7.2 (5.3)	7.2 (5.3)	5.5 (4.1)	4.8 (3.6)
Frequency, Hz	68	68	68	65	80
Amplitude, in (mm)	0.067 (1.7)	0.067 (1.7)	0.067 (1.7)	0.074 (1.9)	0.055 (1.4)
Centrifugal force, lbf (kN)	8,992 (40)	8,992 (40)	8,992 (40)	8,093 (36)	6,294 (28)
Speed, ft/min (m/min)	82 (25)	82 (25)	82 (25)	75 (23)	72 (22)
H/A vibration, standard handle, ft/s <sup>2</sup> (m/s <sup>2</sup> )	5.6 (1.7)	7.9 (2.4)	7.9 (2.4)	11.5 (3.5)	7.5 (2.3)
Sound power, guaranteed, dB(A)	108	108	108	106	108
Sound pressure at operators ears, dB(A)	95	92	92	84	82
Plate width, in (mm)	23.6 (600)	23.6 (600)	19.7 (500)	19.7 (500)	17.7 (450)
Plate length, in (mm)	30.2 (768)	30.2 (768)	30.2 (768)	27.7 (703)	25.7 (654)
Dimensions (L x W x H), in (mm)	54.5 x 23.6 x 44.1 (1,385 x 600 x1,120)	54.5 x 23.6 x 44.1 (1,385 x 600 x1,120)	54.5 x 23.6 x 44.1 (1,385 x 600 x1,120)	52.5 x 19.7 x 44.3 (1,334 x 500 x1,126)	44.1 x 17.7 x 42.6 (1,119 x 450 x1,069)

COMPACTION APPLICATION

GRAVEL | ROCKS



# Duplex Roller

## Applications

- Ideal for compacting thin layers of granular soils and asphalt.
- Compact form factor allows access to job sites where space is a challenge.

## Benefits

- High centrifugal force and speed of the machine let you get more done in less time.
- Equipped with scrapers to keep the drum clean.
- Vibration-damping handle enables a more comfortable work experience for the operator.



<b>Compaction Model</b>	<b>LP 6505</b>
Part No.	967855701

## Technical Specifications

Operating weight, lbs (kgs)	1,687 (765)
Starter type	Electric start
Engine	Hatz 1D42S
Fuel	Diesel EPA
Rated power, hp (kW)	9.6 (7.2)
Frequency, Hz	58
Centrifugal force, lbf (kN)	4,900 (22)
Speed, mph (kmph)	0-2.24 (0.36)
H/A vibration, standard handle, ft/s <sup>2</sup> (m/s <sup>2</sup> )	(4.1)
Sound power, guaranteed, dB(A)	107
Sound pressure at operators ears, dB(A)	88
Drum diameter, in (mm)	15.7 (400)
Drum width, in (mm)	25.6 (650)
Dimensions (L x W x H), in (mm)	43.7/98.4 x 28.3 x 47.8 (1,110/2,500 x 720 x 1,215)

**COMPACTION APPLICATION**

**ASPHALT | SAND | GRAVEL**

# Trench Compactor

## Applications

- Articulated trench compactor delivers a smooth compaction surface that doesn't dig up soil when turning.
- Suitable for all kinds of soil, but especially for cohesive material like clay and silt.
- Highly productive machine in wet or dry conditions.

## Benefits

- Great static compaction capability thanks to the heavy weight of the trench compactor.
- High & wide drum pads increase traction on slopes and steep gradients as well as wet soils.
- Powerful Kubota D1105 engine with low fuel consumption combined with large fuel tank enables a full day's work.



COMPACTION

<b>Compaction Model</b>	<b>LP 9505</b>
Part No.	967950801

## Technical Specifications

Operating weight, lbs (kgs)	3,693 (1,675)
Engine	Kubota D1105
Rated power, hp (kW)	24.3 (18.1)
RPM/min	2,800
Frequency, Hz	42
Amplitude (high/low), in (mm)	.04/.02(1.1/.055)
Centrifugal force (high/low), lbf (kN)	16,186/8,093 (72/36)
Speed - operation, mph (kmph)	0.84 (1.35)
Speed - transport, mph (kmph)	1.7 (2.7)
Drum width, in (mm)	33.5 (850)
Drum diameter, in (mm)	20.6 (523)
Pad height on drums, in (mm)	1.0 (25)
Fuel tank capacity, gal (L)	7.9 (30)
Running time with full tank, hours	8.6
Battery, 2 pieces (exchangable)	one in remote, one in on-board charger
Battery charger	on-board charger in machine

**COMPACTION APPLICATION**

**CLAY | SILT**

# Compaction Accessories

COMPACTION

Accessories		LT 6005	LT 5005
Transport wheel kit	596023801	X	X

Accessories		LF 50 L	LX 90
Block paving kit	594757201	X	
Transport wheel kit	595120701	X	

Accessories		LF 100 LAT	LF 80 LAT	LF 75 LAT - 20"	LF 75 LAT - 17"	LF 60 LAT
Block paving kit	594868201	X		X		
Block paving kit	594868101		X		X	
Block paving kit	595367501					X
Fork lift device	595503101	X	X	X	X	
Transport wheel kit	594204901	X	X	X	X	
Transport wheel kit	595120701					X
Water tank	594961101	X	X	X	X	
Water tank	596327401					X

Accessories		LG 504 - 22"	LG 504 - 28"	LG 504 - 34"	LG 400
Block paving kit	595128901		X		
Block paving kit	594447902				X
Extension plate kit 2x75 mm	594758701	X	X	X	
Extension plate kit 2x150 mm	594758801	X	X	X	

Accessories		LG 300 - 20"	LG 300 - 24"	LG 300 D	LG 204	LG 164
Block paving kit	594830201	X				
Block paving kit	594830301		X	X		
Block paving kit	594852801				X	
Block paving kit	594830101					X
Transport device	594830501	X	X	X		
Transport device	594830501				X	X

Accessories		LP 6505
Safety crank handle kit	594170901	X





# MANAGE YOUR CONCRETE JOBS FROM START TO FINISHED SLAB

Every construction project starts with a solid foundation. We provide you with the tools and solutions to create just that in concrete, delivering maximum productivity, performance and reliability. Our wide range of equipment for concrete placement and finishing covers vibrating, leveling and surfacing.



## How to succeed with your applications

**Vibration:** vibration helps remove the air voids from freshly poured concrete to increase the density of the concrete, making it stronger.

**Leveling:** leveling creates an even surface. This is performed by screeds.

**Surfacing:** power trowels are used for floating and troweling to remove irregularities from the screeded surface. The concrete surface is compacted and sealed, creating a more durable, smooth floor.

## Range Overview

Husqvarna's range of concrete placement equipment includes a wide range of equipment. Gas, electric & external vibrators.

Single, double and modular truss screeds. Three premier walk-behind trowels and four professional ride-on trowels. Our largest line up to date.

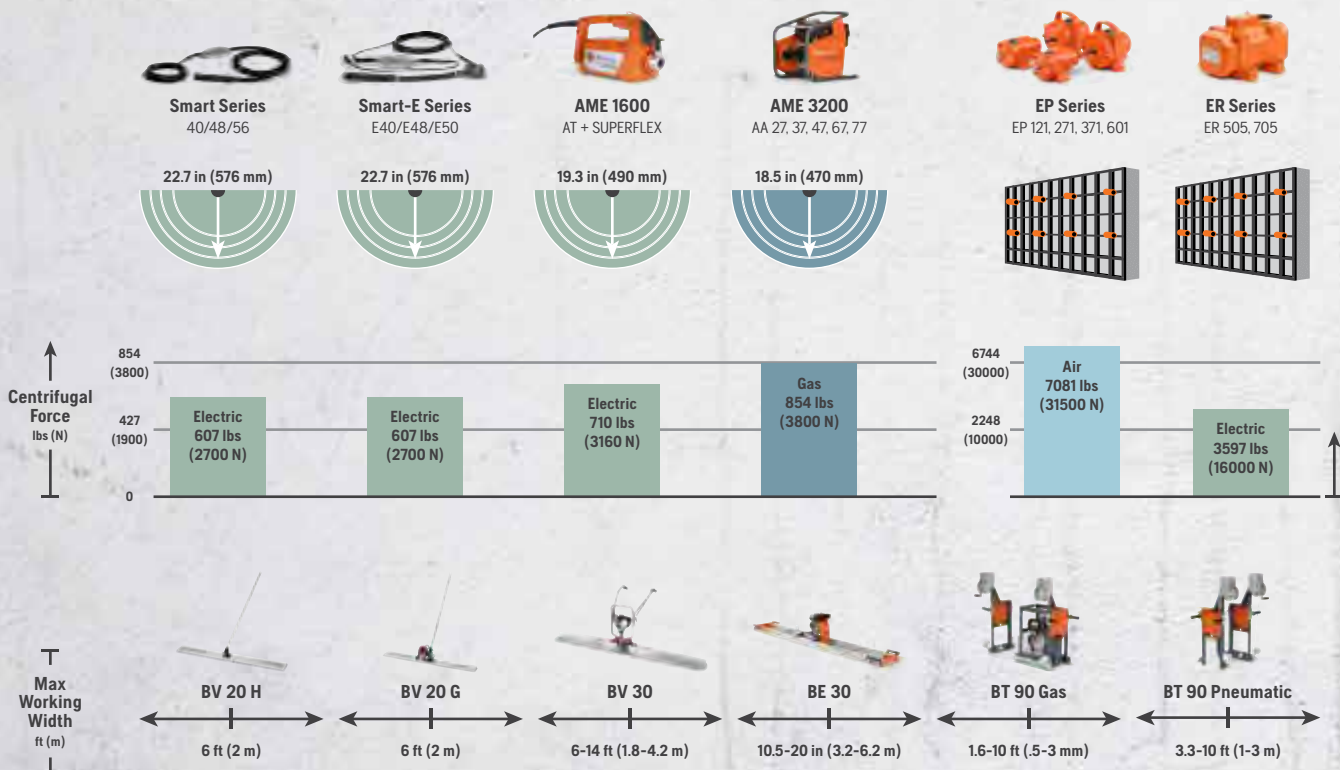





## A Better Way of Working

Every concrete construction starts with a solid foundation. We provide you with the tools and solutions to create just that. We rely on three basic principles: high-performing and well-designed quality equipment, a clear focus on the operator's efficiency, and a service and support network to back you up in any event. That is how we enable you to achieve a better way of working.

Husqvarna's concrete equipment is developed for maximum productivity, performance and reliability. Every little detail within – from the hard-wearing vibrator heads to the reliable trowel motors – is designed to get the job done with maximum uptime and minimum service required.

The operator's efficiency is the key to high production rates and a high-quality job result. By designing the products for easy handling, reliable operation and best possible safety, we enable the operator to stay productive the whole working day.

[Husqvarna Catalog](#)

## Efficient Trowels for Any Size Slab

When finishing concrete slabs, challenges can be many. Worrying about equipment should not be one of them. Our complete range of ride-on trowels will enable you to achieve great results on any job site, no matter the size. The ride-on trowels offer the torque, speed and smart features to finish the job at hand with confidence, while delivering exceptional floor flatness (FF).

The range of ride-on trowels consists of 6-foot, 8-foot and 10-foot machines. All machines have an excellent power-to-weight ratio, providing adequate power to the rotors and ensuring high driving speed.

Ride-on trowels can also be used to polish large concrete surfaces with our HIPERTROWEL method.

[CLICK HERE TO WATCH IT IN ACTION!](#)

# Smart Series High Frequency Electric Vibrators

## Applications

- High Frequency electric vibrator with high centrifugal force, stable speed and high amplitude contribute to efficient concrete vibration with fewer dips, 49 ft (15 m) + 16 ft (5 m) of hose enable exceptional reach around the job.

## Benefits

- Motor-in-head design keeps vibrations in the concrete rather than operator's hands/arm.
- A built-in frequency converter enables the machine to be plugged into a regular, single-phase wall socket.
- Radius of action is 12x the diameter.



Vibrator Model	Smart 56 - 10 M	Smart 56 - 5 M	Smart 48 - 10 M	Smart 48 - 5 M	Smart 40
Part No.	967856008	967856006	967855907	967940205	967855806

## Technical Specifications

Tube diameter, in. (mm)	2.2 (56)	2.20 (56)	1.90 (58)	1.90 (48)	1.58 (40)
Tube length, in. (mm)	15.0 (380)	15.0 (380)	13.8 (350)	13.8 (350)	12.6 (320)
Total weight, lbs (kgs)	35.1 (14.7)	35.1 (14.7)	32.4 (14.7)	32.4 (14.7)	28.9 (13.1)
Hose length, ft (m)	32.8 (10)	16.4 (5)	32.8 (10)	16.4 (5)	16.4 (5)
Cable length, ft (m)	49.2 (15)	49.2 (15)	42.9 (15)	49.2 (15)	49.2 (15)
Voltage, V-p-Hz	110V-1-50/60Hz	110V-1-50/60Hz	110V-1-50/60Hz	115V-1-50/60Hz	115V-1-50/60Hz
Amperage @ 115V-1-50/60Hz, A	12.8	12.8	9	9	5
Frequency, vpm	12,000	12,000	12,000	12,000	12,000
Weighted effective acceleration, ft/s <sup>2</sup> (m/s <sup>2</sup> )	8.1 (2.47)	8.1 (2.47)	19.2 (5.87)	19.2 (5.87)	15 (4.62)
Sound power Lpa dB(A)	94	83	91	80	75

# Smart-E Series High Frequency Electric Vibrators

## Applications

- High Frequency electric vibrator with high centrifugal force, stable speed and high amplitude contribute to efficient concrete vibration with fewer dips, 49 ft (15 m) + 16 ft (5 m) of hose enable exceptional reach around the job.

## Benefits

- Motor-in-head design keeps vibrations in the concrete rather than operator's hands/arm.
- A built-in frequency converter enables the machine to be plugged into a regular, single-phase wall socket.
- Radius of action is 12x the diameter.
- Ergonomic pistol grip reduces vibrations in hands & arms.



CONCRETE PLACEMENT

Vibrator Model	Smart-E 56	Smart-E 48	Smart-E 40
Part No.	967940304	967940206	967855809

## Technical Specifications

Tube diameter, in (mm)	2.2 (56)	1.9 (48)	1.6 (40)
Tube length, in (mm)	15 (380)	13.8 (350)	12.6 (320)
Total weight, lbs (kgs)	35.1 (14.7)	32.4 (14.7)	28.9 (13.1)
Hose length, ft (m)	1.64 (.5)	1.64 (.5)	1.64 (.5)
Cable length, ft (m)	49.2 (15)	49.2 (15)	49.2 (15)
Voltage, V-p-Hz	115V-1-50/60Hz	115V-1-50/60Hz	115V-1-50/60Hz
Amperage @ 115V-1-50/60Hz, A	(12.8)	(9)	(5)
Frequency, vpm	12,000	12,000	12,000
Weighted effective acceleration, ft/s <sup>2</sup> (m/s <sup>2</sup> )	81 (2.47)	19.2 (5.87)	15 (4.62)
Sound power Lpa dB(A)	83	80	75



# AME Series Modular Flex-Shaft Vibrators

## Applications

- Designed for occasional concrete pouring applications.

## Benefits

- Plugs into a regular 115V wall socket and then let the combination of high frequency electric power and mechanic force work for you.
- All shafts and vibrators in this system are equipped with quick couplings for ease of assembly. Instant speed and power from the drive unit provides rapid acceleration contributing to the outstanding performance.
- Radius of action is 10x the diameter.



Vibrator Model	AME 1600
Part No.	967857801

## Technical Specifications

Voltage, V-p-Hz	115V-1-50/60Hz
Power, hp (kW)	2.25 (1,600)
Amperage, (A)	14
Speed, rpm	12 000
Cable length, ft (m)	16 (5)
Weight, lbs (kgs)	13.5 (6.1)
Weighted effective acceleration, ft/s <sup>2</sup> (m/s <sup>2</sup> )	4.16
Sound power Lpa dB(A)	77

Vibrator Heads	AT 59	AT 49	AT 39	AT 29
Part No.	967859604	967859603	967859602	967859601
Tube diameter, in. (mm)	2.37 (59)	2.0 (49)	1.5 (39)	1.125 (29)
Tube length, in. (mm)	12 (306)	12.25 (311)	12.37 (315)	13 (332)
Tube weight, lbs (kgs)	8.62 (3.9)	6 (2.7)	4.62 (2.1)	2.87 (1.3)
Speed (rpm)	12,000	12,000	12,000	12,000
Weighted effective acceleration, ft/s <sup>2</sup> (m/s <sup>2</sup> )	33.8 (10.29)	32 (9.74)	29 (8.86)	40 (12.09)

Flexible Shafts	SUPERFLEX 40	SUPERFLEX 30	SUPERFLEX 20	SUPERFLEX 10
Part No.	967859505	967859504	967859503	967859501
Length, ft (m)	13 (4)	10 (3)	6.5 (2)	3.25 (1)
Weight, lbs (kgs)	16 (7.3)	12.37 (5.6)	8.37 (3.8)	5.0 (2.4)



AT 49



AT 39



SUPERFLEX 40



SUPERFLEX 30



SUPERFLEX 20

# AMG Series Mechanical Vibrators

## Applications

- Classic mechanical pendulum vibrator used for concrete pouring applications.

## Benefits

- Constant high vibration and simple design make them reliable, effective and offer great economical value.
- The conical shape of the pendulum raceway increases the friction area within the vibrator head to keep speed up and prevent rpm losses.
- Induction-hardened magnesium steel alloy is used in the major wearing parts and steel reinforcement in the rubber hose contribute to a long service life.
- Radius of action is 10x the diameter.



<b>Vibrator Model</b>	<b>AMG 3200</b>
Part No.	967857201

## Technical Specifications

Engine model	Honda GX160 UT1 SXS4 SD, 4-strokes
Engine speed, rpm	3000
Power @ 3000 rpm, hp (kW)	4.8 (3.6)
Fuel tank capacity, qts (L)	0.82 (3.1)
Total weight, lbs (kg)	33.06 (15)
Oil "alert"	Yes
Sound power lpa dB(A)	75.7

Vibrator Heads	AA 77	AA 67	AA 47	AA 37	AA 27
Part No.	967857701	967857601	967857501	967857401	967857301
Tube diameter, in (mm)	2.95 (75)	2.48 (63)	1.97 (50)	1.53 (39)	1 (25)
Tube length, in (mm)	20.0 (510)	19.7 (500)	16.5 (420)	14.4 (366)	13.1 (334)
Total weight, lbs (kgs)	64 (29)	55.1 (25)	50.7 (23)	41.9 (19)	22 (10)
Hose length, ft (m)	19.7 (6)	19.7 (6)	19.7 (6)	19.7 (6)	19.7 (6)
Frequency, vpm	9,200	10,500	11,200	12,000	12,000
Weighted effective acceleration, ft/s <sup>2</sup> (m/s <sup>2</sup> )	10.4 (3.16)	8.7 (2.66)	11.5 (3.52)	5.1 (1.56)	8 (2.46)
Sound power Lpa dB(A)	75.7	75.8	73	68	69



AA 77



AA 67



AA 47



AA 37



AA 27

# ER (Electric) Series External Vibrators

## Applications

- External vibrators suitable for all concrete mixes on civil engineering sites and in precast factories.

## Benefits

- High-quality components and materials help keep life cycle and maintenance costs down.
- All external vibrators are mounted on quick-release brackets. This makes them easier to move, so fewer units are required.



Vibrator Model	ER 705	ER 505
Part No.	967969602	967973002
Part No. (bracket)	-	597267501

## Technical Specifications

Speed, rpm	3,000	9,000
Max. centrifugal force, N	7,400	8,100
Intensity at 230 V/400 V, A	2.3/1.33	1,200
Weight, lbs (kgs)	48.5 (22)	21 (9.5)



# EP (Pneumatic) Series External Vibrators

## Applications

- External vibrators suitable for all concrete mixes on civil engineering sites and in precast factories.

## Benefits

- High-quality components and materials help keep life cycle and maintenance costs down.
- All external vibrators are mounted on quick-release brackets. This makes them easier to move, so fewer units are required.



Vibrator Model	EP 601 B	EP 371 B	EP 271 B	EP 121 B
Part No.	967970001	967969901	967969801	967969701
Part No. (bracket)	597157101	597157101	597157201	597157201

## Technical Specifications

Speed, rpm	8,800	9,350	9,350	9,000
Max. centrifugal force, N	31,500	26,800	10,350	8,100
Air consumption, l/min	1,400	1,400	1,200	1,200
Weight, lbs (kgs)	40 (18)	36.4 (16.5)	22 (10)	21 (9.5)
Bracket attachment	VT4	VT4	VT2	VT2



# BV 20 Series Walk-Behind Screeds

## Applications

- Manual and gas-powered options depending on your job site needs.
- BV 20 G can be used directly on thin slabs up to 6 in (150 mm) with only vibrating the edges beforehand.

## Benefits

- Non-corrosive, lightweight aluminum/magnesium profiles allow for easy handling and maintenance.
- Adjustable speeds on the motorized options.
- In-depth action - 2 in (50 mm) for BV 20, 6 in (200 mm) for BV 20 G



Screed Model	BV 20 H	BV 20 G
Part No.	967856101	967856201

## Technical Specifications

Working width, ft (m)	6 (2)	6 (2)
Operating weight, lbs (kgs)	15 (7)	43 (20)
Engine type	-	Honda GX25 N S3, 4-strokes
Power at 7,000 rpm, hp (kW)	-	1 (0.72)
Fuel tank capacity, qts (L)	-	0.15 (0.58)
Transmission	-	direct
Speed, rpm	-	4,000-7,000
Max bullfloat pitch	15°	15°
Centrifugal force, Lbf (N)	-	247 (1,100)
Weighted effective acceleration, ft/s <sup>2</sup> (m/s <sup>2</sup> )	-	10.5 (3.2)
Sound power Lpa dB(A)	0	91

Noise level, in dB (A), measured in the air at 1 m from the beam in accordance with standard ISO 11201. Uncertainty: ± 3 dB. Weighted rms acceleration measured at the wrist (m/s<sup>2</sup>), in accordance with standard ISO 5349.

# BV 30 Walk-Behind Screed

## Applications

- Use directly on thin slabs up to 4 in (100 mm) with only vibrating the edges beforehand.

## Benefits

- Non-corrosive, lightweight aluminum/magnesium profiles allow for easy handling and maintenance.
- Adjustable speeds on the motorized options.
- BV 30 features a rigid bottom plate in a V-shape profile that drives excess concrete backwards, refilling operator foot marks.
- In-depth action - 4 in (100 mm) BV 30.



CONCRETE PLACEMENT

Screed Model	BV 30
Part No.	967856301

## Technical Specifications

Working width, ft (m)	6-14 (1.8-4.3)
Operating weight, lbs (kgs)	30 (14)
Engine type	Honda GX35 OHC, 4-strokes
Power at 7,000 rpm, hp (kW)	1.6 (1)
Fuel tank capacity, qts (L)	0.17 (0.65)
Transmission	Centrifugal clutch
Speed, rpm	2,000-7,400
Max bullfloat pitch	-
Centrifugal force, Lbf (N)	777 (3,460)
Weighted effective acceleration, ft/s <sup>2</sup> (m/s <sup>2</sup> )	10.5 (3.25)
Sound power Lpa dB(A)	108

Noise level, in dB (A), measured in the air at 1 m from the beam in accordance with standard ISO 11201. Uncertainty: ± 3 dB. Weighted rms acceleration measured at the wrist (m/s<sup>2</sup>), in accordance with standard ISO 5349.

Screed Blades	6ft Blade	8ft Blade	10ft Blade	12ft Blade	14ft Blade
Part No.	967858701	967858801	967858901	967859001	967859101
Length, ft (m)	6 (1.8)	8 (2.4)	10 (3)	12 (3.6)	14 (4.2)
Weight, lbs (kgs)	14.3 (6.5)	17.6 (8)	21.2 (9.6)	24.7 (11.2)	28.2 (12.8)



6ft Blade



8ft Blade



10ft Blade



12ft Blade



14ft Blade

# BE/BD Double Beam System Screed

## Applications

- With BD double beam lengths from 10.5 ft (3.2 m) to 20 ft (6.2 m) you can work on any medium to large flooring construction sites.
- Use for both surface vibration and leveling by rotating the drive unit 90 degrees.

## Benefits

- Sturdy, yet lightweight aluminum design allows for easy handling and excellent balance to achieve even concrete floors.
- Areas exposed to wet concrete have smooth, easy-clean surfaces.
- Lightweight, non-corrosive aluminum alloy makes for easy handling and transportation.
- In-depth action - 6 in (150 mm)



Screed Model	BE 30
Part No.	9967941202

## Technical Specifications

Drive model	Honda GX120 UT1 SXS4 SD - 4-stroke
Power, hp (kW)	3.5 (2.6)
Speed, RPM	3,600
Direction of rotation	Counterclockwise
Tank capacity, gal (L)	0.5 (2)
Starter	Recoil starter
Sound pressure, Lpa dB(A)	75.7
Sound power, Lw dB(A)	103.8
Total weight, lbs (kgs)	70.5 (32)

BD Blades	BD 32	BD 42	BD 52	BD 62
Part No.	967956001	967956101	967956201	967956301
Height, in (mm)	4 (100)	4 (100)	4 (100)	4 (100)
Length, ft (m)	10.5 (3.2)	13.8 (4.2)	17 (5.2)	20 (6.2)
Width, in (mm)	15.7 (400)	15.7 (400)	15.7 (400)	15.7 (400)
Total weight, lbs (kgs)	70 (32)	90 (41)	103 (47)	125.6 (57)



BD 32



BD 42



BD 52



BD 62

# BT 90 Modular Truss Screeds

## Applications

- BT 90 is engineered to handle concrete surfaces with a width up to 82 ft (25m).

## Benefits

- Modular truss screed systems are engineered to be easy to assemble, adjust camber and go to work.
- Built-in winches
- The BT 90's triangular frames and square tubes provide better rigidity and oscillating bearings with grease nipples extend the product's life-time and serviceability.



CONCRETE PLACEMENT

Screed Model	BT 90 Gas	BT 90 Pneumatic
Part No.	967941103	967941108

## Technical Specifications

Powered by, bars	-	3-6
Input, hp (kW)	6.7 (5)	-
Minimum air flow, CFM (m <sup>3</sup> /m)	-	9 (0.26)
Frequency, RPM	2,900	-
Working length, in (mm)	22 (560)	14 (355)
Width x Height, in (mm)	23 x 39 (585 x 1,000)	24 x 38 (610 x 970)
Weight, lbs (kgs)	205 (93)	88 (40)

BT Gas Screeds	1.6 FT	2.5 FT	3.3 FT	6.6 FT	10 FT
Part No.	967941104	967941116	967941105	967941106	967941107
Height, in (mm)	14.8 (376)	14.8 (376)	14.8 (376)	14.8 (376)	14.8 (376)
Working length, ft (m)	19.6 (500)	29.5 (750)	39.4 (1,000)	78.7 (2,000)	118 (3,000)
Total width, in (mm)	16.5 (420)	16.5 (420)	16.5 (420)	16.5 (420)	16.5 (420)
Weight, lbs (kgs)	53 (24)	61.7 (28)	70.5 (32)	125.6 (57)	180 (82)

BT Pneumatic Screeds	3.3 FT	6.6 FT	10 FT
Part No.	967941109	967941110	967941111
Height, in (mm)	14.8 (376)	14.8 (376)	14.8 (376)
Working length, ft (m)	39.4 (1,000)	78.7 (2,000)	118 (3,000)
Total width, in (mm)	16.5 (420)	16.5 (420)	16.5 (420)
Weight, lbs (kgs)	70.5 (32)	127 (58)	183 (83)



BT Gas 3.3 ft



BT Gas 6.6 ft



BT Gas 10 ft



BT Pneumatic 3.3 ft



BT Pneumatic 6.6 ft



BT Pneumatic 10 ft

CONCRETE PLACEMENT

CONCRETE SCREEDS



# CT 48 Series Walk-Behind Trowels

## Applications

- Ideal for finishing or burnishing medium and large areas.

## Benefits

- Patented dynamically balanced trowels (when blades are turning) offer nearly effortless operation and maximum control at all speeds with all types of blades, including floats.
- Transmission brake, electronic safety switch and engine speed sensor offer additional triple protection for the user.
- Variable speeds: low for floating, high for burnishing.



Trowel Model	CT 48-8A	CT 48-11A	CT 48-13A-V
Part No. (twist pitch handle)	970465601	-	-
Part No. (adjustable twist pitch handle)	970465602	-	970465605
Part No. (adjustable pro shift handle)	970465603	970465604	970465606

## Technical Specifications

Troweling diameter, in (mm)	48 (1,129)	48 (1,129)	48 (1,129)
Operating weight, lbs (kgs)	234 (106)	250 (113)	268 (122)
Operating performance (SAE J1349), hp (kW)	7.1 (5.3)	10.7 (8)	11.7 (9)
Pitch range	0-30	0-30	0-30
Rotor speed (min/max), RPM	60/125	60/125	25/200
Quantity of blades	4	4	4
Engine	Honda, air-cooled single-cylinder	Honda, air-cooled single-cylinder	Honda, air-cooled single-cylinder
Motor	4-cycle gasoline	4-cycle gasoline	4-cycle gasoline
Engine type	GX240	GX340	GX390
RPM's	3,600	3,600	3,600
Fuel consumption, gal/h (L/h)	0.71 (2.6)	0.71 (2.6)	0.71 (2.6)
Tank capacity, gals (L)	1.6 (6)	1.6 (6)	1.6 (6)
Dimensions (L x W x H), in (mm)	85 x 48 x 41 (2,159 x 1,219 x 1,041)	85 x 48 x 41 (2,159 x 1,219 x 1,041)	85 x 48 x 41 (2,159 x 1,219 x 1,041)

# CT 36 Series Walk-Behind Trowels

## Applications

- Perfect for finishing medium-sized areas.

## Benefits

- Patented dynamically balanced trowels (when blades are turning) offer nearly effortless operation and maximum control at all speeds with all types of blades, including floats.



CONCRETE  
PLACEMENT

Trowel Model	CT 36-5A	CT 36-8A	CT 36-8-V
Part No. (twist pitch handle)	970465501	-	
Part No. (adjustable twist pitch handle)	970465502	970465504	970465506
Part No. (adjustable pro shift handle)	970465503	970465505	970465507

## Technical Specifications

Troweling diameter, in (mm)	36 (914)	36 (914)	36 (914)
Operating weight, lbs (kgs)	183 (83)	208 (94)	208 (84)
Operating performance (SAE J1349), hp (kW)	4.8 (3.6)	7.1 (5.3)	7.1 (5.3)
Pitch range	0-30	0-30	0-30
Rotor speed (min/max), RPM	60/125	60/125	25/200
Quantity of blades	4	4	4
Engine	Honda, air-cooled single-cylinder	Honda, air-cooled single-cylinder	Honda, air-cooled single-cylinder
Motor	4-cycle gasoline	4-cycle gasoline	4-cycle gasoline
Engine type	GX160	GX240	GX240
RPM's	3,600	3,600	3,600
Fuel consumption, gal/h (L/h)	0.48 (1.82)	0.48 (1.82)	0.48 (1.82)
Tank capacity, gals (L)	1.6 (6)	2 (7.3)	2 (7.3)
Dimensions (L x W x H), in (mm)	60.9 x 24 x 41 (1,547 x 610 x 1,041)	79 x 36 x 41 (2,006 x 914 x 1,041)	79 x 36 x 41 (2,006 x 914 x 1,041)

# BG 245 Walk-Behind Trowel

## Applications

- Perfect for finishing small areas.

## Benefits

- Quick stop immediately halts the machine when you let go of the handle.



<b>Trowel Model</b>	<b>BG 245</b>
Part No. (twist pitch handle)	967928801

## Technical Specifications

Troweling diameter, in (mm)	24 (600)
Operating weight, lbs (kgs)	132 (60)
Operating performance (SAE J1349), hp (kW)	3.5 (2.6)
Pitch range	0-18
Rotor speed (min/max), RPM	40/115
Quantity of blades	4
Engine	Honda, air-cooled single-cylinder
Motor	4-cycle gasoline
Engine type	GX120
RPM's	3,600
Fuel consumption, gal/h (L/h)	1.06 (3.8)
Tank capacity, gals (L)	0.7 (2.5)
Dimensions (L x W x H), in (mm)	58.5 x 24 x 38 (1,485 x 610 x 962)





# CRT 60X Ride-On Trowel

## Applications

- Smoothing large concrete areas.

## Benefits

- Patented computer constantly monitors the engine speed and adjust the hydraulic load at the same time.
- Power steering, via joysticks, enables accurate maneuvering and virtually fatigue-free working.



Trowel Model	CRT 60X
Part No.	970461801

## Technical Specifications

Troweling diameter, in (mm)	59 (1,499)
Operating weight, lbs (kgs)	2,720 (1,234)
Operating performance (SAE J1995), hp (kW)	74 (55)
Quantity of blades	12
Blade combination, in (mm)	23 x 8 (584 x 203)
Blade finish, in (mm)	23 x 6 (584 x 152)
Blade float pan, in (mm)	60 (1,524)
Pitch range	0-25
Rotor speed (min/max) RPM	25/132
Engine	Kohler
Motor	Liquid-cooled 4-cylinder turbo charged diesel
Displacement, in <sup>3</sup> (cc)	151.4 (2,481)
RPM	2,600
Engine oil, gals (L)	2.25 (8.5)
Fuel type	Diesel
Fuel consumption, gal/h (L/h)	3.3 (12.5)
Tank capacity (fuel), gal (L)	12 (45)
Tank capacity (water), gal (L)	12 (45)
Runtime, hours	3.6
Dimensions (L x W x H), in (mm)	127 x 65 x 57 (3,225 x 1,575 x 1,448)

# CRT 48PS Series Ride-On Trowel

## Applications

- Ideal for large pours and elevated deck applications where lighter weight machines are preferred.

## Benefits

- Electro-hydraulic joystick controls enables accurate maneuvering and virtually fatigue-free operation.
- Two control modes to accommodate operator preference in varying site conditions.



CONCRETE PLACEMENT

Trowel Model	CRT 48-37V-PS	CRT 48-57K-PS
Part No.	970461606	970461611

## Technical Specifications

Troweling diameter, in (mm)	48 (1,219)	48 (1,219)
Operating weight, lbs (kgs)	1,300 (590)	1,456 (660)
Operating performance (SAE J1349), hp (kW)	37 (28)	-
Operating performance (SAE J1995), hp (kW)	-	57 (42.8)
Quantity of blades	10	10
Blade combination, in (mm)	18 x 8 (457 x 203)	18 x 8 (457 x 203)
Blade finish, in (mm)	18 x 6 (457 x 152)	18 x 6 (457 x 152)
Blade float pan, in (mm)	18 x 10 (457 x 254)	18 x 10 (457 x 254)
Pitch range	0-25	0-25
Rotor speed (min/max) RPM	25/170	25/150
Engine	Briggs & Stratton	Kubota
Motor	Air-cooled, V-twin gasoline	Liquid-cooled, 4-cylinder gasoline
Displacement, in <sup>3</sup> (cc)	61 (1,000)	93.8 (1,537)
RPM	4,000	3,600
Fuel type	Unleaded gasoline	Unleaded gasoline
Fuel consumption, gal/h (L/h)	2.8 (10.6)	2.5 (9.5)
Tank capacity (fuel), gal (L)	6.5 (24.6)	6.5 (24.6)
Tank capacity (water), gal (L)	2.4 (9)	2.4 (9)
Runtime, hours	2.5	2.6
Dimensions (L x W x H), in (mm)	101 x 51 x 58 (2,565 x 1,295 x 1,473)	101 x 51 x 59 (2,565 x 1,295 x 1,498)

# CRT 48 Series Ride-On Trowel

## Applications

- Ideal for large pours and elevated deck applications where lighter weight machines are preferred.

## Benefits

- Electro-hydraulic joystick controls enables accurate maneuvering and virtually fatigue-free operation.
- Two control modes to accommodate operator preference in varying site conditions.



Trowel Model	CRT 48-37K	CRT 48-33K-DF	CRT 48-37V	CRT 48-57K
Part No.	970461607	970461608	970461604	970461603

## Technical Specifications

Troweling diameter, in (mm)	48 (1,219)	48 (1,219)	48 (1,219)	48 (1,219)
Operating weight, lbs (kgs)	1,280 (581)	1,205 (546.6)	1,205 (546.6)	1,428 (648)
Operating performance (SAE J1349), hp (kW)	32.4 (24)	37 (28)	37 (28)	-
Operating performance (SAE J1995), hp (kW)	-	-	-	57 (42.5)
Quantity of blades	10	10	10	10
Blade combination, in (mm)	18 x 8 (457 x 203)	18 x 8 (457 x 203)	18 x 8 (457 x 203)	18 x 8 (457 x 203)
Blade finish, in (mm)	18 x 6 (457 x 152)	18 x 6 (457 x 152)	18 x 6 (457 x 152)	18 x 6 (457 x 152)
Blade float pan, in (mm)	18 x 10 (457 x 254)	18 x 10 (457 x 254)	18 x 10 (457 x 254)	18 x 10 (457 x 254)
Pitch range	0-25	0-25	0-25	0-25
Rotor speed (min/max) RPM	25/160	25/170	25/170	25/150
Engine	Kubota	Kubota	Briggs & Stratton	Kubota
Motor	Liquid-cooled 3-cylinder 4-cycle gasoline	Air-cooled, V-twin gasoline	Air-cooled, V-twin gasoline	Liquid-cooled 4-cylinder 4-cycle gasoline
Displacement, in <sup>3</sup> (cc)	58.7 (962)	61 (1,000)	61 (1,000)	93.8 (1,537)
RPM	3,600	4,000	4,000	3,600
Fuel type	Unleaded gasoline	Unleaded gasoline/LP	Unleaded gasoline	Unleaded gasoline
Fuel consumption, gal/h (L/h)	3 (11)	2.8 (10.6)	2.8 (10.6)	2.5 (9.5)
Tank capacity (fuel), gal (L)	6.5 (24.6)	6.5 (24.6)	6.5 (24.6)	6.5 (24.6)
Tank capacity (water), gal (L)	3.6 (13.6)	2.4 (9)	2.4 (9)	1.6 (6)
Runtime, hours	2.5	2.5	2.5	2.5
Dimensions (L x W x H), in (mm)	101 x 51 x 58 (2,565 x 1,295 x 1,473)	101 x 51 x 58 (2,565 x 1,295 x 1,473)	101 x 51 x 58 (2,565 x 1,295 x 1,473)	101 x 51 x 59 (2,565 x 1,295 x 1,498)

# CRT 36 Ride-On Trowel

## Applications

- Ideal for smoothing large concrete areas.

## Benefits

- Optimum maneuverability due to its balanced power-to-weight ratio.
- Unique variable clutch offers proper torque and speed range to match concrete conditions without mechanical adjustments.



CONCRETE PLACEMENT

Trowel Model	CRT 36-26A
Part No.	970461401
Part No. (wheel kit)	970461402

## Technical Specifications

Troweling diameter, in (mm)	36 (914)
Operating weight, lbs (kgs)	817 (371)
Operating performance (SAE J1349), hp (kW)	22.2 (16.6)
Quantity of blades	8
Blade combination, in (mm)	14 x 8 (356 x 203)
Blade finish, in (mm)	14 x 6 (356 x 152)
Blade float pan, in (mm)	14 x 10 (356 x 254)
Pitch range	0-25
Rotor speed (min/max) RPM	25/160 or 50/140
Engine	Honda
Motor	Air-cooled 2-cylinder, 4-cycle gasonline engine
Displacement, in <sup>3</sup> (cc)	42 (688)
RPM	3,600
Fuel type	Unleaded gasoline
Fuel consumption, gal/h (L/h)	2.4 (9)
Tank capacity (fuel), gal (L)	6.5 (24.6)
Tank capacity (water), gal (L)	2.1 (8)
Runtime, hours	3.3
Dimensions (L x W x H), in (mm)	80 x 41 x 54 (2,032 x 1,041 x 1,372)



# Concrete Placement Accessories

Accessories		Smart 56	Smart 48	Smart 40	SmartE 56	SmartE 48	SmartE40
Elastomer end cap (40)	595156701	X	X	X	X	X	X
Elastomer end cap (48)	595156801	X	X	X	X	X	X
Elastomer end cap (56)	595029601	X	X	X	X	X	X

Accessories		CT 48	CT 36	BG 245
Blade Set Combo Blades   Set of 4   24"	594709901			X
Blade Set Finish Blades   Set of 4   36"	598929501		X	
Blade Set Combo Blades   Set of 4   36"	598929502		X	
Blade Set Finish Blades   Set of 4   48"	598929801	X		
Blade Set Combo Blades   Set of 4   48"	598929802	X		
Bottle Holder Bracket Kit	598928901	X	X	
Floating disc, 24"	594244001			X
Lifting Bracket 36"	598927301		X	
Lifting Bracket 48"	598927302	X		
Lift Kit, 36" (for use with a 2x4)	598928801		X	
Lift Kit, 48" (for use with a 2x4)	598928802	X		
Pan Pak 2 PC   Super Flat   4-Blade   48"	598930202	X		
Pan Pallet 10 PC   Super Flat   4-Blade   48"	598930302	X		
Trowel Blade, bolt on (4 piece pack)	594709901			X
Transportation wheels (2 piece pack)	596192301			X
Weight Kit set of 2 (10 lbs each)	598929101	X	X	

Accessories		CRT 60X	CRT 48-PS	CRT 48	CRT 36
Blade Set Finish Blades   Set of 4   36"	598929501				X
Blade Set Combo Blades   Set of 4"   36"	598929502				X
Blade Set Finish Blades   Set of 4   48"	598929801		X	X	
Blade Set Combo Blades   Set of 4"   48"	598929802		X	X	
Blade Set Finish Blades   Set of 4   60"	598930701	X			
Blade Set Combo Blades   Set of 4"   60"	598930702	X			
Float Pan 60"	598930801	X			
Pan Pak 2 PC   36"	598930201				X
Pan Pallet 10 PC   Flat Float   36"	598930301				X
Pan Pak 2 PC   Super Flat   5-Blade   48"	598930203		X	X	
Pan Pallet 10 PC   Super Flat   5-Blade   48"	598930303		X	X	
Pan Pak 2 PC   Flat   5-Blade   48"	598930204		X	X	
Pan Pallet 10 PC   Flat   5-Blade   48"	598930304		X	X	
Transport Trolley Wheel Kit	598929001		X	X	
Transport Wheel Replacement Wheels (2)	598929901		X	X	
Weight Kit Set of 2 (10 lbs each)	598929101		X	X	





# CUT ULTRA EARLY FOR STRAIGHT LINES - OR WAIT FOR RANDOM CRACKS TO APPEAR

Husqvarna Soff-Cut® is an ideal system for Ultra Early Entry™ sawing of contraction joints one to two hours after pouring a concrete slab. It is the best solution for minimizing the risk of random cracking, which is one of the most costly and aggravating problems for a concrete contractor. The saws' high production rates combined with the opportunity to pour and cut the same day, and of course, the nice straight lines achieved by only shallow cutting depths all make Soff-Cut® the perfect system.

## Don't wait for random cracks to appear

Husqvarna Soff-Cut is ideal for the Ultra Early Entry™ sawing of contraction joints after pouring concrete slabs. The system is designed to minimize the risk of random cracks – one of the most costly and aggravating problems faced by concrete contractors. The main benefits are the high production rates, the ability to pour and cut concrete on the same day, and of course, the nice, straight line achieved by only cutting shallow depths.



## Range Overview

The Husqvarna Soff-Cut® range includes six models with cutting depths from 1" to 4", powered by engines from 3 hp to 25 hp, and weighing 85 lbs to 495 lbs. For optimal production rates, choose the Soff-Cut® model suitable for your project.

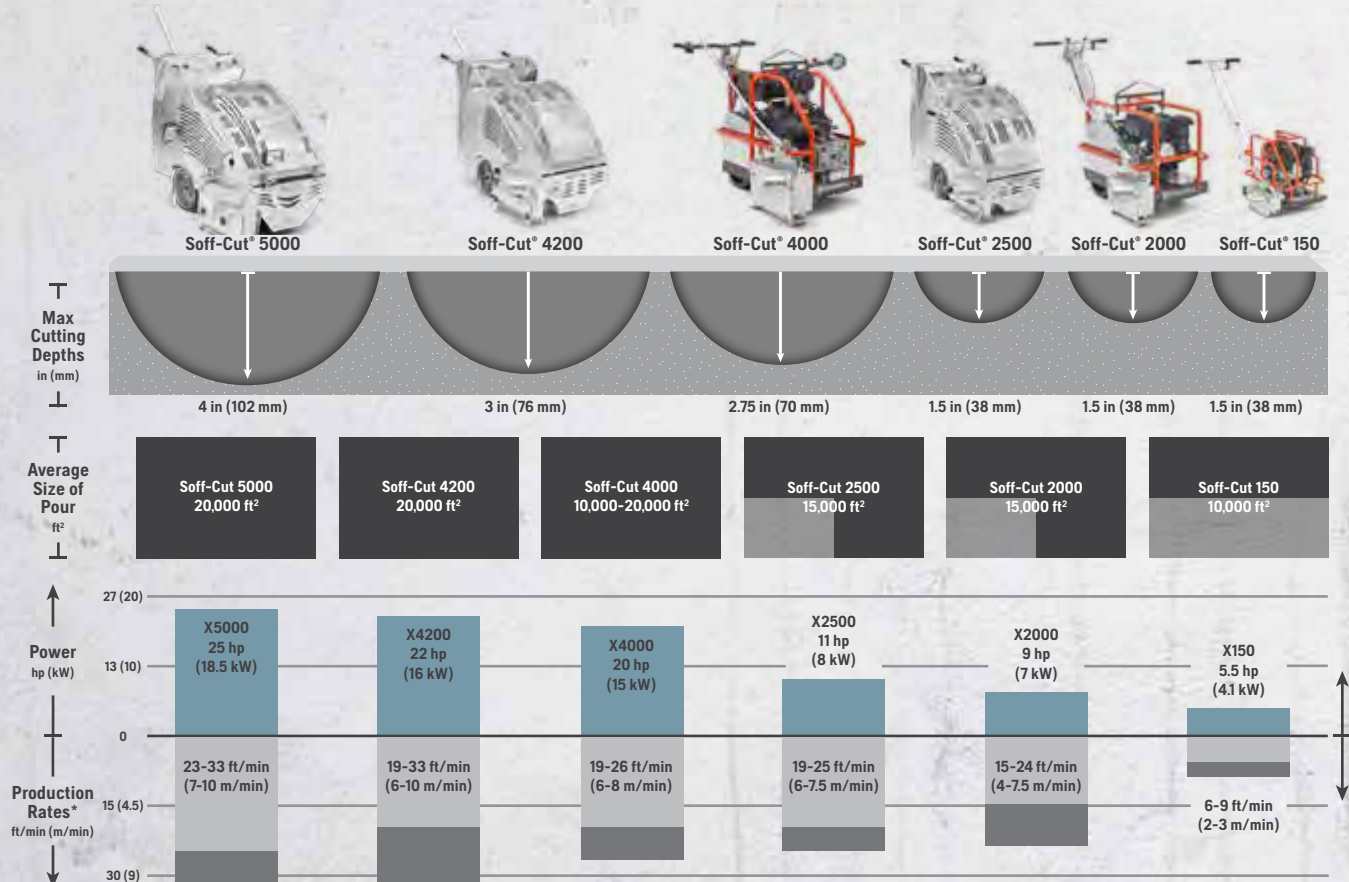

\*Production Rates. Please note that the production rates are rough averages and may vary due to: depth of cut, proper blade selection or cutting in the green zone.

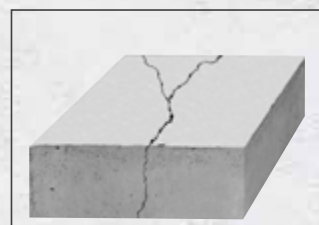

[CLICK HERE TO LEARN MORE](#)

**Contraction Joint Sawing** - As the concrete slab hydrates and begins to set, it develops internal stresses. These stresses need to be relieved in a controlled way before they seek their own relief in the form of a random crack. By cutting control joints as a final step of the finishing process, you create a pattern of predetermined weakened planes in the concrete that subsequently crack at the bottom of the cuts.

**The Problem** - As concrete hydrates and begins to set, it develops internal stresses. The objective in controlling shrinkage cracking is to relieve these stresses before they seek their own relief in the form of a random crack.

**The System** - The Husqvarna Soff-Cut® system is the optimal way to control random cracking. With Ultra Early Entry™ cutting you can control cracking in slabs up to 8.8 in (225 mm) thick, with only a 1 in (25 mm) minimum depth, within the Green Zone™ (1–2 hours after pouring).

**The Solution** - With the Husqvarna Soff-Cut Ultra Early Entry™ dry-cutting system, joints are sawn in the Green Zone™ – within the first hour or two after finishing. The Husqvarna Soff-Cut technology is based on the combination of the Soff-Cut blade and skid plate. The up-cutting rotation of the blade combines with the skid plate, which applies pressure to the surface to prevent chipping and spalling. To effectively control shrinkage cracking, Soff-Cut allows you to cut in the Green Zone as part of the finishing process.

**How to Succeed** - Start sawing as soon as you're sure the concrete will support the weight of the saw and operator without marking or damaging the concrete. You don't have a lot of time. Determine the layout of the joints in advance. Ensure straight cuts by drawing guidelines on the surface to follow. Start the job with a new, unused Husqvarna XL Series dry-cutting diamond blade and anti-ravel skid plate.



# Husqvarna Soff-Cut® 5000

## Applications

- Perfect high-production saw for airport runways and highways.
- Several blade widths can be used, allowing different joint widths and crack control to occur simultaneously.

## Benefits

- A self-propelled gasoline saw maximizes green sawing performance with positraction drive and hydrostatic transmission.
- 15 amp regulated charging system maintains maximum performance while saw is making multiple cuts over short distances.
- The low-noise blade block enclosure reduces noise and dust impact on surrounding areas when cutting in the Green Zone™.



SOFF-CUT™

Soff-Cut® Model	Soff-Cut® 5000
Part No. (dust port now included)	966845704

## Technical Specifications

Blade range, in (mm)	12-14 (305-350)
Depth of cut, in (mm)	2-4 (50-100)
Maximum power, hp (kW)	25 (18)
Engine specifications	Kohler CH740
Average bladeshaft, rpm	3,100
Blade flanges, in (mm)	4.75 (120)
Displacement, cu in (l)	44 (725)
Bore/stroke, in (mm)	3.3/2.6 (83/67)
Maximum weight crated, lbs (kgs)	593 (269)
Maximum weight uncrated, lbs (kgs)	495 (225)
Dimensions uncrated, pointer and blade guard up, handles in, in (mm) L x W x H	95 x 30.5 x 41 (2,413 x 775 x 1,041)

Power source	Gasoline	Axle front/rear, in (mm)	1/1 (25.4/25.4)
Arbor size	Triangular	Wheels rear, in (mm)	11 x 4 (279 x 102) 2 each
Bladeshaft diamter, in (mm)	1.5 (38)	Blade guard type	Enclosed
Cylinders/cycle	2/4	Number of belts	1 (4 band 3VX)
Fuel capacity, gal (L)	3.16 (12)	Blade depth control	Electric
Air filter	Heavy Duty Canister	Oil capacity, qt (L)	2 (1.9)
Starter	Electric	Handlebar adjustment	Electric
Engine cooling	Air	Transmission type	Hydrostatic
Wheels front, in (mm)	4 x 4 (102 x 102) 2 each		

\*As rated by the engine manufacturer.

# Husqvarna Soff-Cut® 4200

## Applications

- A high-production saw used on medium to large commercial, industrial and paving projects.
- Several blade widths can be used, allowing different joint widths and crack control to occur simultaneously.

## Benefits

- A self-propelled gasoline saw maximizes green sawing performance with positraction drive and hydrostatic transmission.
- Switch-activated electronic adjustable handles increase operator comfort and reduce fatigue.
- High-strength, lightweight aluminum frame increases stability for better cutting performance.



Soff-Cut® Model	Soff-Cut® 4200
Part No. (dust port now included)	966845604

## Technical Specifications

Blade range, in (mm)	10-13.5 (254-343)
Depth of cut, in (mm)	1.125-3 (28.5-76)
Maximum power, hp (kW)	22 (16)
Engine specifications	Kohler CH680
Average bladeshaft, rpm	3,500
Blade flanges, in (mm)	5-7/8 (150)
Displacement, cu in (l)	41.1 (674)
Bore/stroke, in (mm)	3.2/2.6 (80/67)
Maximum weight crated, lbs (kgs)	568 (258)
Maximum weight uncrated, lbs (kgs)	488 (221)
Dimensions uncrated, pointer and blade guard up, handles in, in (mm) L x W x H	89 x 30 x 40.25 (2,261 x 762 x 1,022)

Power source	Gasoline	Axle front/rear, in (mm)	1/1 (25.4/25.4)
Arbor size	Triangular	Wheels rear, in (mm)	11 x 4 (279 x 102) 2 each
Bladeshaft diamter, in (mm)	1.5 (38)	Blade guard type	Enclosed
Cylinders/cycle	2/4	Number of belts	1 (3 band 3VX)
Fuel capacity, gal (L)	3.16 (12)	Blade depth control	Electric
Air filter	Heavy Duty Canister	Oil capacity, qt (L)	2 (1.9)
Starter	Electric	Handlebar adjustment	Electric
Engine cooling	Air	Transmission type	Hydrostatic
Wheels front, in (mm)	4 x 2 (102 x 51) 1 each		

\*As rated by the engine manufacturer.

# Husqvarna Soff-Cut® 4000

## Applications

- Perfect for industrial and large production jobs.
- Heavy-duty saw that uses several blade widths to allow for different joint widths and crack control to occur simultaneously.

## Benefits

- Self-propelled gasoline saw with hydrostatic transmission that enables consistent forward cutting speeds.
- Electronic key start enables easy starting of the machine.
- Electric blade depth control reduces operator fatigue and increases production.
- Mechanical remote retractable front guide enables operator to raise/lower the guide while cutting.



## Soff-Cut® Model

## Soff-Cut® 4000

Part No. (dust port now included)

966845505

## Technical Specifications

Blade range, in (mm)	10-13.5 (254-343)
Depth of cut, in (mm)	1125-2.75 (28.5-76)
Maximum power, hp (kW)	20 (15)
Engine specifications	Kohler CH640
Average bladeshaft, rpm	3,500
Blade flanges, in (mm)	5-7/8 (150)
Displacement, cu in (l)	391 (640)
Bore/stroke, in (mm)	3/2.6 (77/67)
Maximum weight crated, lbs (kgs)	518 (235)
Maximum weight uncrated, lbs (kgs)	420 (191)
Dimensions uncrated, pointer and blade guard up, handles in, in (mm) L x W x H	94 x 29 x 34 (2,388 x 737 x 864)

Power source	Gasoline	Axle front/rear, in (mm)	1/1 (25.4/25.4)
Arbor size	Triangular	Wheels rear, in (mm)	10 x 3-5/8 (254 x 92) 2 each
Bladeshaft diamter, in (mm)	1.5 (38)	Blade guard type	Enclosed
Cylinders/cycle	2/4	Number of belts	1 (3 band 3VX)
Fuel capacity, gal (L)	4.34 (16.4)	Blade depth control	Electric
Air filter	Heavy Duty Canister	Oil capacity, qt (L)	2 (1.9)
Starter	Electric	Handlebar adjustment	Electric
Engine cooling	Air	Transmission type	Hydrostatic
Wheels front, in (mm)	4 x 4 (102 x 102) 2 each		

\*As rated by the engine manufacturer.

# Husqvarna Soff-Cut® 2500

## Applications

- A high-production saw ideal for medium to large commercial, industrial applications.
- Perfect for warehouse or retail spaces.
- Several blade widths can be used, allowing different joint widths and crack control to occur simultaneously.

## Benefits

- A self-propelled gasoline saw maximizes green sawing performance with positraction drive and hydrostatic transmission.
- Switch-activated electronic adjustable handles increase operator comfort and reduce fatigue.
- High-strength, lightweight aluminum frame increases stability for better cutting performance.



Soff-Cut® Model	Soff-Cut® 2500
Part No. (dust port now included)	966845403

## Technical Specifications

Blade range, in (mm)	9-10 (228-254)
Depth of cut, in (mm)	7/8-1.5 (16-38)
Maximum power, hp (kW)	11 (8)
Engine specifications	Honda GX390
Average bladeshaft, rpm	3,200
Blade flanges, in (mm)	4.25 (108)
Displacement, cu in (l)	23.7 (389)
Bore/stroke, in (mm)	3.5/2.5 (88/63.5)
Maximum weight crated, lbs (kgs)	418 (190)
Maximum weight uncrated, lbs (kgs)	347 (157)
Dimensions uncrated, pointer and blade guard up, handles in, in (mm) L x W x H	76 x 23 x 36 (1,930 x 584 x 914)

Power source	Gasoline	Axle front/rear, in (mm)	3/4 - 1 (19/25.4)
Arbor size	Triangular	Wheels rear, in (mm)	8 x 3 (203 x 76) 2 each
Bladeshaft diamter, in (mm)	1.25 (32)	Blade guard type	Enclosed
Cylinders/cycle	1/4	Number of belts	1 (2 band 3VX)
Fuel capacity, gal (L)	1.6 (6)	Blade depth control	Electric
Air filter	Dry Type Dual Element	Oil capacity, qt (L)	2.3 (11)
Starter	Electric	Handlebar adjustment	Electric
Engine cooling	Air	Transmission type	Hydrostatic
Wheels front, in (mm)	4 x 3 (102 x 76) 2 each		

\*As rated by the engine manufacturer.



# Husqvarna Soff-Cut® 2000

## Applications

- Used on medium to large commercial, industrial projects.
- Durable saw that uses several blade widths to allow for different joint widths and crack control to occur simultaneously.

## Benefits

- Self-propelled gasoline saw with hydrostatic transmission, which enables consistent forward cutting speeds.
- Electronic remote key start and choke easily start the machine.
- The low-noise blade block enclosure reduces noise and dust impact on surrounding areas when cutting in the Green Zone™.
- Roll cage frame with built-in lifting system protects engine and simplifies transporting.



Soff-Cut® Model	Soff-Cut® 2000
Part No. (dust port now included)	966845303

## Technical Specifications

Blade range, in (mm)	9-10 (228-254)
Depth of cut, in (mm)	7/8-1.5 (22-38)
Maximum power, hp (kW)	9 (7)
Engine specifications	Kohler CH395
Average bladeshaft, rpm	3600
Blade flanges, in (mm)	4.25 (108)
Displacement, cu in (l)	16.9 (277)
Bore/stroke, in (mm)	2.9/2.3 (75/60)
Maximum weight crated, lbs (kgs)	388 (176)
Maximum weight uncrated, lbs (kgs)	317 (144)
Dimensions uncrated, pointer and blade guard up, handles in, in (mm) L x W x H	94 x 29 x 34 (2,388 x 737 x 864)

Power source	Gasoline	Axle front/rear, in (mm)	1/1 (25.4/25.4)
Arbor size	Triangular	Wheels rear, in (mm)	10 x 3-5/8 (254 x 92) 2 each
Bladeshaft diamter, in (mm)	1.25 (32)	Blade guard type	Enclosed
Cylinders/cycle	1/4	Number of belts	1 (3 band 3VX)
Fuel capacity, gal (L)	1.59 (6)	Blade depth control	Manual
Air filter	Dry Type Dual Element w/Precleaner	Oil capacity, qt (L)	1.05 (1)
Starter	Electric	Handlebar adjustment	Fixed
Engine cooling	Air	Transmission type	Push
Wheels front, in (mm)	4 x 4 (102 x 102) 2 each		

\*As rated by the engine manufacturer.

# Husqvarna Soff-Cut® 150/150 D

## Applications

- Push saw designed for residential and light commercial contractors where depth of 1.5" is needed (150).
- Great for contractors that handle some decorative cutting or cleaning-up of spalled cuts (150 D).

## Benefits

- Increased depth of cut when using new 6.5" blades.
- Gasoline saw with easy pull-start engine facilitates fast, reliable starts.
- The low-noise blade block enclosure reduces noise and dust impact on surrounding areas when cutting in the Green Zone™ (150).
- Mechanical blade depth control enables operator to quickly raise and lower the saw.



Soff-Cut® Model	Soff-Cut® 150	Soff-Cut® 150 D
Part No. (dust port now included)	966844811	966844810

## Technical Specifications

Blade range, in (mm)	4-6.5 (101-165)	ProEdge Blades
Depth of cut, in (mm)	1.5 (38)	0.5 (12)
Maximum power, hp (kW)	5.5 (4.1)	5.5 (4.1)
Engine specifications	Kohler CH255	Kohler CH255
Average bladeshaft, rpm	3,800	3,800
Blade flanges, in (mm)	3 (76)	3 (76)
Displacement, cu in (l)	10.8 (0.18)	10.8 (0.18)
Bore/stroke, in (mm)	2.7/1.9 (68/49)	2.7/1.9 (68/49)
Maximum weight crated, lbs (kgs)	100 (45)	100 (45)
Maximum weight uncrated, lbs (kgs)	87 (39)	97 (44)
Dimensions uncrated, pointer and blade guard up, handles in, in (mm) L x W x H	68 x 19 x 33.5 (1,727 x 483 x 851)	68 x 19 x 33.5 (1,727 x 483 x 851)

Power source	Gasoline	Axle front/rear, in (mm)	1/1 (25.4/25.4)
Arbor size	Triangular	Wheels rear, in (mm)	3 x 3 (76 x 76) 2 each
Bladeshaft diamter, in (mm)	3/4 (19)	Blade guard type	Enclosed
Cylinders/cycle	1/4	Number of belts	1
Fuel capacity, gal (L)	0.7 (2.7)	Blade depth control	Manual
Air filter	Dry Type Dual Element w/Precleaner	Oil capacity, qt (L)	0.63 (0.6)
Starter	Recoil	Handlebar adjustment	Folding/Fixed with locking pin
Engine cooling	Air	Transmission type	Push
Wheels front, in (mm)	3 x 3 (76 x 76) 2 each		*As rated by the engine manufacturer.

# Husqvarna Soff-Cut® 150 E

## Applications

- Push saw designed for residential and light commercial contractors where depth of 1.5" is needed.

## Benefits

- Increased depth of cut when using new 6.5" blades.
- The low-noise blade block enclosure reduces noise and dust impact on surrounding areas when cutting in the Green Zone™.
- Mechanical blade depth control enables operator to quickly raise and lower the saw.



Soff-Cut® Model	Soff-Cut® 150 E
Part No. (dust port now included)	967973901

## Technical Specifications

Blade range, in (mm)	4-6 (101-165)
Depth of cut, in (mm)	1.5 (38)
Maximum power, hp (kW)	3 (2.2)
Voltage	208-230
Plug type	L6-20
Cycle/Current	60/AC
Full load amps	12.5
Average bladeshaft, rpm	3,700
Blade flanges, in (mm)	3 (76)
Maximum weight crated, lbs (kgs)	105 (48)
Maximum weight uncrated, lbs (kgs)	93 (42)
Dimensions uncrated, pointer and blade guard up, handles in, in (mm) L x W x H	68 x 19 x 33.5 (1,727 x 483 x 851)

Power source	Electric	Engine cooling	Air
Arbor size	Triangular	Blade guard type	Enclosed
Bladeshaft diameter, in (mm)	3/4 (19)	Number of belts	1
Axle front/rear, in (mm)	1/1 (25.4/25.4)	Blade depth control	Manual
Wheels front, in (mm)	3 x 3 (76 x 76) 2 each	Handlebar adjustment	Folding/Fixed with locking pin
Wheels rear, in (mm)	3 x 3 (76 x 76) 2 each	Transmission type	Push

\*As rated by the engine manufacturer.

# Husqvarna T 4000 Petrol with Soff-Cut® Kit

## Applications

- Large-scale projects that demand substantial dust extraction.
- Specialized for Soff-Cut applications with an integrated pre-separator, which captures up to 90% of the dust before it reaches the pre-filter.

## Benefits

- Larger wheels are designed to handle the weight of the machine without creating marks on green concrete.
- Three separate filtering stages collect dust from the heaviest to the finest dust particles.
- Individually tested and certified HEPA filters rated at 99.99% @ 0.3 microns.
- Longopac® bag hose system ensures simple and safe dust bag changes.
- Jet pulse filter cleaning system ensures high continuous airflow due to easy and efficient cleaning of main filter without opening the machine.



Soff-Cut® Model	T 4000 Petrol with Soff-Cut® Kit
Part No.	967973301

## Technical Specifications

Power, hp (kW)	10.2 (7.6)
Engine/Engine Manufacturer	Gasoline/Honda
Max air flow, CFM/h (m³/h)	285 (484)
Max vacuum, kPa	26
Water lift, in (mm)	104 (2,642)
Main hose diameter, in (mm)	2.5 (63)
Main hose length, ft (m)	33 (10)
Additional hose, diameter x length	2" x 25' (51 mm x 7.5 m)
HEPA filter % @ 0.3 µm	> 99.99
HEPA filter, qty	2
Starter	Electric
Running time per tank	≈40 min
Weight, lbs (kgs)	453 (203)
Dimensions L x W x H, in (mm)	63 x 30 x 63 (1,600 x 762 x 1,600)

**ADDITIONAL ACCESSORIES IN DUST & SLURRY SECTION - PAGE 234**

**DIAMOND BLADE SECTION**

**PAGE 132**



# Husqvarna Soff-Cut® Accessories & Spare Parts

Accessories		5000	4200	4000	2500	2000	150	150 D	150 E
Headlight	505752201				X				
Headlight kit	505485002		X						
Headlight/side light	505485003	X							
Ignition key, 2 pack	505798301	X	X						
Ignition key, 2 pack	505826001				X				
Light kit, field installed	594915201			X		X			
ProEdge height adjustment mechanism	505398101						X	X	
Side light	505486901				X				
Side light assembly	505486902		X						
Wrench, blade	505719901	X	X	X	X	X			
Spare Parts		5000	4200	4000	2500	2000	150	150 D	150 E
Aluminium wrap for battery	505487801		X						
Battery 12 VDC	505487601	X	X						
Belt, pump	505484002					X			
Belt, pump	505484003	X							
Belt, pump	505484004			X	X				
Belt, pump belt (2 pack)	505484802		X						
Blade belt, blade 4 band (1 each)	505283201	X							
Blade belt, 1 each	505483902			X					
Blade belt, 1 each	505691501					X			
Blade belt 2 band (1 each)	505740401				X				
Blade belt, set of two single belts	505482201						X	X	
Bladeshaft belt, 20"x 4 or 30" x 4	505777401		X						
Blade block, vac port	595844101	X							
Blade block, vac port	595844001		X						
Blade block, vac port	595843901			X					
Blade block, vac port	595843601				X				
Blade block, vac port	595843501					X			
Blade block (150)	510272111						X	X	X
Blade block conversion kit	510272113							X	
Blade block repair kit	585190901		X						
Blade block repair kit	585299101			X					
Blade block repair kit	585299102						X	X	X
Bolt, blade arbor hex	505483701	X	X	X	X	X	X	X	X
Bulb, headlight	505752401	X	X		X				
Bulb, side light	505787501		X						
Bulb, side light	505752601				X				
Cable, blade release	505482701						X	X	X
Cable, guide	505487501			X					X
Cover knobs, blade block	505482901	X	X	X	X	X	X	X	X
Driver tube set	505484202			X		X			X
Filter, air kit (replacement; 2 main, 2 inner)	505482306	X	X	X					
Filter, air kit (replacement Honda)	505744901				X				
Filter, air kit (replacement Kohler)	594110201						X	X	
Filter, air kit (pre-filter & air filter)	598939201					X			
Filter, engine oil	505797401	X	X						
Guide wheel - 1/8" (150 D ONLY)	505590201						X	X	
Guide wheel - 1/4" (150 D ONLY)	505590601						X	X	
Guide wheel - 1/2" (150 D ONLY)	505590701						X	X	
Guide wheel - 3/8" (150 D ONLY)	505590901						X	X	
Key switch	505484401					X			
Lens, headlight	505752301				X				
Pulley, blade idler	505484501					X			
Pulley, idler	505483401	X	X		X				
Pully kit, blade idler	505484502	X							
Pulley, pump idler	505484601					X			
Snapper pin (holds skid plate)	505775401	X	X	X	X	X	X	X	
Spark plug (Kohler)	505666601	X	X	X					
Spark plug (Honda)	505747401				X	X			
Spark plug (Robin)	593131701						X	X	
Spring, blade idler	505796901	X	X						
Spring, blade idler	505737301			X	X	X			
Spring, pump idler	505774601	X					X	X	
Spring, pump idler	505737901		X		X	X			
Starter (motor)	505484302			X					
Starter (motor)	505484301					X			
Switch (for all actuators), 5 pack	505487201	X	X		X				
Switch, for all actuators	582518501	X	X		X				
Switch, for lights	582518601	X	X		X				
Wrench, blade	505483102							X	X

# Soff-Cut® Dust Control



Dust Ports		T-Line Vacuums				
Dry Applications		T 18000	T 10000	T 8600/P	T 7500	T 4000 P
Soff-Cut® 5000, 3" outlet	505494007	X	X	X	X	
Soff-Cut® 4200, 3" outlet	505494006	X	X	X	X	
Soff-Cut® 4000, 3" outlet	597218401	X	X	X	X	
Soff-Cut® 2500, 3" outlet	505494004	X	X	X	X	
Soff-Cut® 2000, 3" outlet	505494003	X	X	X	X	

Dust Ports		S-Line Vacuums		
Dry Applications		S 36	S 26	S 13
Soff-Cut® 150/150D, 2" outlet	589949001	X	X	X

Objective testing results available on [www.husqvarnacp.com/us/silica](http://www.husqvarnacp.com/us/silica)



5000 Dust Port Cover, 3"



4200 Dust Port Cover, 3"



4000 Dust Port Cover, 3"



2500 Dust Port Cover, 3"



2000 Dust Port Cover, 3"



150/150 D Dust Port Cover, 2"

# Soff-Cut® Diamond Blades



SOFF-CUT®

BLADE COLOR						
XL SERIES BLADE APPLICATIONS	XL-1000	XL-2000	XL-3000	XL-4000	XL-5000	XL-6000
ULTRA-HARD AGGREGATE, NON-ABRASIVE SAND (FLINT)	● ● ●	-	-	-	-	-
HARD AGGREGATE, NON-ABRASIVE SAND (CHERT)	● ●	● ● ●	● ●	-	-	-
MEDIUM TO HARD AGGREGATE, MEDIUM ABRASIVE SAND (TRAP-ROCK)	●	● ●	● ● ●	-	-	-
MEDIUM AGGREGATE, MEDIUM ABRASIVE SAND (QUARTZ)	-	●	● ● ●	-	-	-
MEDIUM TO SOFT, AGGREGATE, ABRASIVE SAND (GRANITE)	-	-	● ●	● ● ●	● ●	-
SOFT AGGREGATE, ABRASIVE SAND (LIMESTONE)	-	-	●	● ●	● ● ●	● ●
SOFT AGGREGATE, SOFT LIMESTONE SAND	-	-	-	●	● ●	● ● ●

●●●= Optimal ●●= Good ●= Acceptable - = Not recommended

BLADE COLOR		
VARI-CUT® & FLX SERIES BLADE APPLICATIONS	Vari-Cut® & FLX 1000	Vari-Cut® & FLX 3000
ULTRA-HARD AGGREGATE, NON-ABRASIVE SAND (FLINT)	● ● ●	-
HARD AGGREGATE, NON-ABRASIVE SAND (CHERT)	● ●	-
MEDIUM TO HARD AGGREGATE, MEDIUM ABRASIVE SAND (TRAP-ROCK)	●	● ● ●
MEDIUM AGGREGATE, MEDIUM ABRASIVE SAND (QUARTZ)	-	● ●
MEDIUM TO SOFT, AGGREGATE, ABRASIVE SAND (GRANITE)	-	●
SOFT AGGREGATE, ABRASIVE SAND (LIMESTONE)	-	-

●●●= Optimal ●●= Good ●= Acceptable - = Not recommended

BLADE COLOR			
PAVER BLADE APPLICATIONS	PAVER 2000	PAVER 4000	PAVER 6000
ULTRA-HARD AGGREGATE, NON-ABRASIVE SAND (FLINT)	● ● ●	-	-
HARD AGGREGATE, NON-ABRASIVE SAND (CHERT)	● ●	-	-
MEDIUM TO HARD AGGREGATE, MEDIUM ABRASIVE SAND (TRAP-ROCK)	● ●	● ●	-
MEDIUM AGGREGATE, MEDIUM ABRASIVE SAND (QUARTZ)	●	● ● ●	-
MEDIUM TO SOFT, AGGREGATE, ABRASIVE SAND (GRANITE)	-	● ●	● ●
SOFT AGGREGATE, ABRASIVE SAND (LIMESTONE)	-	●	● ● ●

●●●= Optimal ●●= Good ●= Acceptable - = Not recommended

# Soff-Cut® Diamond Blades

## Excel Series Blades

### ULTRA EARLY ENTRY™ SAW BLADES

- Excel 1000 Purple: Ultra hard aggregate, non-abrasive sand.
- Excel 2000 Green: Hard aggregate, non-abrasive sand.
- Excel 3000 Red: Medium-hard aggregate, medium abrasive sand.
- Skid plate included with each purchase.



#### Excel Series Blades

Sizes - Inches (mm)	Blade	Saw Model	Part Number
<b>XL-1000</b>			
6 (152) x .100	XL6-1000	150	542777005
6.5 (165) x .100	XL6.5-1000	150	582826901
8 (203) x .100	XL8-1000	1500/750/450	542756137
10 (254) x .100	XL10-1000	2000/2500	542756100
10 (254) x .250	XL10S14-1000	2000/2500	542756292
12 (305) x .120	XL12-1000	4000/4200	542756105
12 (305) x .220	XL12S22-1000	4000/4200	542756164
12 (305) x .250	XL12S14-1000	4000/4200	542756291
12 (305) x .380	XL12S38-1000	4000/4200	542756273
13.5 (343) x .120	XL14-1000	4000/4200	542756112
13.5 (343) x .250	XL14S14-1000	4000/4200	542756261
<b>XL-2000</b>			
6 (152) x .100	XL6-2000	150	542777006
8 (203) x .100	XL8-2000	1500/750/450	542756131
10 (254) x .100	XL10-2000	2000/2500	542756101
12 (305) x .120	XL12-2000	4000/4200	542756106
13.5 (343) x .120	XL14-2000	4000/4200	542756113
<b>Paver Blades</b>			
12 (305) x .120	PV12-2000	5000	542756170
12 (305) x .250	PV12S14-2000	5000	542756207
12 (305) x .380	PV12S38-2000	5000	510384601
12 (305) x .500	PV12S50-2000	5000	542756211
14 (350) x .120	PV14-2000	5000	542756173
14 (350) x .250	PV14S14-2000	5000	542756176
<b>XL-3000</b>			
5 (127) x .095	XL5-3000A	390	542756118
5.5 (140) x .095	XL5.5-3000A	390	542756121
6 (152) x .100	XL6-3000	150	542777007
6 (152) x .225	XL6S225-3000	150	542777011
6.5 (165) x .100	XL6.5-3000	150	582827001
8 (203) x .100	XL8-3000	1500/750/450	542756132
8 (203) x .225	XL8S225-3000	1500/750/450	542756158
9 (230) x .100	XL9-3000	2000/2500	542756159
10 (254) x .100	XL10-3000	2000/2500	542756102
10 (254) x .250	XL10S14-3000	2000/2500	542756161
10 (254) x .380	XL10S38-3000	2000/2500	542756189
12 (305) x .120	XL12-3000	4000/4200	542756107
12 (305) x .250	XL12S14-3000	4000/4200	542756165
12 (305) x .380	XL12S38-3000	4000/4200	542756197
12 (305) x .500	XL12S50-3000	4000/4200	542756199
13.5 (343) x .120	XL14-3000	4000/4200	542756114
13.5 (343) x .250	XL14S14-3000	4000/4200	542756168
13.5 (343) x .380	XL14S38-3000	4000/4200	510401601



# Soff-Cut® Diamond Blades

## Excel Series Blades

### ULTRA EARLY ENTRY™ SAW BLADES

- Excel 4000 Orange: Medium aggregate, medium abrasive sand.
- Excel 5000 Yellow: Medium-soft aggregate, abrasive sand.
- Excel 6000 Black: Soft aggregate, abrasive sand.
- Skid plate included with each purchase.



#### Excel Series Blades

Sizes - Inches (mm)	Blade	Saw Model	Part Number
<b>XL-4000</b>			
6 (152) x .100	XL6-4000	150	542777008
6.5 (165) x .100	XL6.5-4000	150	582831401
8 (203) x .100	XL8-4000	1500/750/450	542756133
10 (254) x .100	XL10-4000	2000/2500	542756103
12 (305) x .120	XL12-4000	4000/4200	542756108
12 (305) x .220	XL12S22-4000	4000/4200	542756111
13.5 (343) x .120	XL14-4000	4000/4200	542756115
<b>Paver blades</b>			
12 (305) x .120	PV12-4000	5000	542756171
12 (305) x .250	PV12S14-4000	5000	542756208
14 (350) x .120	PV14-4000	5000	542756174
14 (350) x .250	PV14S14-4000	5000	542756177
<b>XL-5000</b>			
5 (127) x .095	XL5-5000A	390	542756138
5.5 (140) x .095	XL5.5-5000A	390	542756123
6 (152) x .100	XL6-5000	150	542777009
8 (203) x .100	XL8-5000	1500/750/450	542756134
9 (230) x .100	XL9-5000	2000/2500	542756160
10 (254) x .100	XL10-5000	2000/2500	542756104
10 (254) x .250	XL10S14-5000	2000/2500	542756163
10 (254) x .380	XL10S38-5000	2000/2500	542756190
12 (305) x .120	XL12-5000	4000/4200	542756109
12 (305) x .250	XL12S14-5000	4000/4200	542756166
12 (305) x .380	XL12S38-5000	4000/4200	542756198
12 (305) x .500	XL12S50-5000	4000/4200	542756200
13.5 (343) x .120	XL14-5000	4000/4200	542756116
13.5 (343) x .250	XL14S14-5000	4000/4200	542756169
13.5 (343) x .380	XL14S38-5000	4000/4200	542756206
<b>XL-6000</b>			
6 (152) x .100	XL6-6000	150	542756150
8 (203) x .100	XL8-6000	1500/750/450	542756179
10 (254) x .100	XL10-6000	2000/2500	542756136
12 (305) x .120	XL12-6000	4000/4200	542756110
13.5 (343) x .120	XL14-6000 V	4000/4200	542756167
<b>Paver blades - X5000 only</b>			
12 (305) x .120	PV12-6000	5000	542756172
14 (350) x .120	PV14-6000	5000	542756175

# Soff-Cut® Diamond Blades

## Vari-Cut™ Series Blades

### ULTRA EARLY ENTRY™ SAW BLADES

- Vari-Cut™ Purple: Ultra hard aggregate, non-abrasive sand.
- Vari-Cut™ Red: Hard-medium aggregate, abrasive sand.
- Skid plate included with each purchase.



#### Vari-Cut™ Series Blades

Sizes - Inches (mm)	Blade	Saw Model	Part Number
<b>Vari-Cut™ Purple</b>			
6 (152) x .100	VC6-1000	150	<b>587665201</b>
12 (305) x .120	VC12-1000	4000/4200	<b>587665205</b>
13-½ (343) x .120	VC14-1000	4000/4200	<b>587665208</b>
13-½ (343) x .250	VC14S14-1000	4000/4200	<b>587665209</b>
<b>Vari-Cut™ Red</b>			
6 (152) x .100	VC6-3000	150	<b>587668201</b>
12 (305) x .120	VC12-3000	4000/4200	<b>587668205</b>
13-½ (343) x .120	VC14-3000	4000/4200	<b>587668208</b>
13-½ (343) x .250	VC14S14-3000	4000/4200	<b>587668209</b>

# Soff-Cut® Diamond Blades

## FLX Series Blades

### ULTRA EARLY ENTRY™ SAW BLADES

- FLX Purple: Ultra hard aggregate, non-abrasive sand.
- FLX Red: Hard-medium aggregate, abrasive sand.
- Skid plate included with each purchase.



#### FLX Series Blades

Sizes - Inches (mm)	Blade	Saw Model	Part Number
<b>FLX Purple</b>			
6 (152) x .100	FLX6-1000	150	575383221
6.5 (165) x .100	FLX6.5-1000	150	582798302
8 (203) x .100	FLX8-1000	1500/750/450	575383222
10 (254) x .100	FLX10-1000	2000/2500	575383203
10 (254) x .250	FLX10S14-1000	2000/2500	542757405
12 (305) x .120	FLX12-1000	4000/4200	575383204
12 (305) x .250	FLX12S14-1000	4000/4200	542757406
13.5 (343) x .120	FLX14-1000	4000/4200	575383205
13.5 (343) x .250	FLX14S14-1000	4000/4200	542757407
14 (350) x .120	FLX14-1000PV	5000	542773825
<b>FLX Red</b>			
5 (127) x .095	FLX5-3000A	390	575383223
5.5 (140) x .095	FLX5.5-3000A	390	575383224
6 (152) x .100	FLX6-3000	150	575383225
6.5 (165) x .100	FLX6.5-3000	150	582854701
8 (203) x .100	FLX8-3000	1500/750/450	575383226
10 (254) x .100	FLX10-3000	2000/2500	575383213
10 (254) x .250	FLX10S14-3000	2000/2500	542756293
12 (305) x .120	FLX12-3000	4000/4200	575383214
12 (305) x .250	FLX12S14-3000	4000/4200	542756282
13.5 (343) x .120	FLX14-3000	4000/4200	575383215
13.5 (343) x .250	FLX14S14-3000	4000/4200	542757408
14 (350) x .120	FLX14-3000PV	5000	542757410

SOFF-CUT™

# Soff-Cut® Diamond Blades

## FLX Series Blades

### ULTRA EARLY ENTRY™ SAW BLADES

- FLX Orange: Medium-soft aggregate, abrasive sand.
- FLX 0.080" Thin: Use when thin cuts are specified.
- Skid plate included with each purchase.



#### FLX Series Blades

Sizes - Inches (mm)	Blade	Saw Model	Part Number
<b>FLX Orange</b>			
6 (152) x .100	FLX6-4000	150	<b>575383227</b>
6.5 (165) x .100	FLX6.5-4000	150	<b>582824201</b>
8 (203) x .100	FLX8-4000	1500/750/450	<b>575383228</b>
10 (254) x .100	FLX10-4000	2000/2500	<b>575383218</b>
10 (254) x .250	FLX10S14-4000	2000/2500	<b>542757378</b>
12 (305) x .120	FLX12-4000	4000/4200	<b>575383219</b>
12 (305) x .250	FLX12S14-4000	4000/4200	<b>542757409</b>
13.5 (343) x .120	FLX14-4000	4000/4200	<b>575383220</b>
13.5 (343) x .250	FLX14S14-4000	4000/4200	<b>542773822</b>
14 (350) x .120	FLX14-4000PV	5000	<b>542773808</b>
<b>FLX Thin Blades</b>			
10 (254) x .080 (2)	FLX10S8-1000	2000/2500	<b>542757453</b>
10 (254) x .080 (2)	FLX10S8-3000	2000/2500	<b>542757452</b>
10 (254) x .080 (2)	FLX10S8-4000	2000/2500	<b>542757454</b>
12 (254) x .080 (2)	FLX12S8-1000RH	4000/4200	<b>542757450</b>
12 (254) x .080 (2)	FLX12S8-3000RH	4000/4200	<b>542757449</b>
12 (254) x .080 (2)	FLX12S8-4000RH	4000/4200	<b>542757451</b>

#### Joint Protectors

Description	Color	Part Number
Bag of 150 – For 5", 5.5" x .095" wide blades	Black	<b>505483201</b>
Bag of 150 – For 6", 8", 10" x .100" wide blades	Red	<b>505483202</b>
Bag of 150 – For 12", 14" x .120" wide blades	Blue	<b>505483203</b>
Bag of 50 – For 5", 6", 8", 12" x .225" wide blades	Red	<b>505483204</b>
Bag of 50 – For 10", 12", 14" x .250" wide blades	Blue	<b>505483205</b>
Bag of 50 – For all .380" wide blades	Red	<b>505483206</b>





# Soff-Cut® Diamond Blades

## Pro-Edge Series Blades

### JOINT PROFILE BLADES

- Bevel cuts with straighter joint lines, higher production and reduced labor versus hand tooling.
- Residential and commercial applications: driveways, sidewalks, hardscape, patios, pool decks, parking garages and commercial sitework.
- ProEdge blades and model 390, 150 and 150 D saws can be used to chase standard joints the day after early entry dry-cut control joints are cut.



#### ProEdge Series Diamond Blades for 390 Electric Saw

Sizes - Inches (mm)	Description	Saw Model	Part Number
5 (127) x .375 V x (.125 Pilot)	V-Line XL5-V21	390	542756141
5 (127) x .625 V x (.125 Pilot)	V-Line XL5-V23	390	542756142
5 (127) x .625 V x (.250 Pilot)	V-Line XL5-V25	390	542756143
5 (127) x .250 Radius x (.125 Pilot)	Radius Line XL5-R250	390	542756144
5 (127) x .500 Radius x (.125 Pilot)	Radius Line XL5-R500	390	542756145

#### ProEdge Series Diamond Blades for 150/150 D Saws

6 (152) x .375 V x (.125 Pilot)	V-Line XL6-V21	150/150D	542756151
6 (152) x .625 V x (.125 Pilot)	V-Line XL6-V23	150/150D	542756152
6 (152) x .625 V x (.250 Pilot)	V-Line XL6-V25	150/150D	542756153
6 (152) x .750 V x (.380 Pilot)	V-Line XL6-V38	150/150D	542756154
6 (152) x 1.0 V x (.500 Pilot)	V-Line XL6-V500	150/150D	542756155
6 (152) x .250 Radius x (.125 Pilot)	Radius Line XL6-R250	150/150D	542756156
6 (152) x .500 Radius x (.125 Pilot)	Radius Line XL6-R500	150/150D	542756157

#### ProEdge Series Diamond Blades for Hand Grinders

5 (127) x .375 V x (.125 Pilot)	V-Line XL5-V21-5/8-7/8	Hand grinder	582090801
5 (127) x .625 V x (.125 Pilot)	V-Line XL5-V23-5/8-7/8	Hand grinder	582046201
5 (127) x .625 V x (.250 Pilot)	V-Line XL5-V25-5/8-7/8	Hand grinder	582046401
5 (127) x .250 Radius x (.125 Pilot)	Radius Line XL5-R250-5/8-7/8	Hand grinder	501450201
5 (127) x .500 Radius x (.125 Pilot)	Radius Line XL5-R500-5/8-7/8	Hand grinder	582047901

#### Husqvarna Bushing Accessory

5/8 for 5" & 5.5"	Small Tri-Arbor	-	505645701
-------------------	-----------------	---	-----------

#### Husqvarna Score Cutting Blades for 150 Saw

4 (102) x .100	XL4-Score	150	516029402
----------------	-----------	-----	-----------

# Soff-Cut® Diamond Blades

## Decorative Cuts JOINT PROFILE BLADES

- After the initial Soff-Cut joints have been cut and the concrete is cured, a ProEdge bevel blade may be used to chase the standard joints for a decorative beveled look. The result is a more polished, finished appearance.



XL-V21

XL-V23

XL-V25

XL-R250

XL-R500

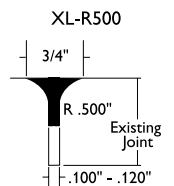
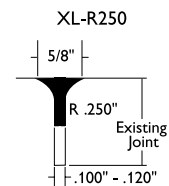
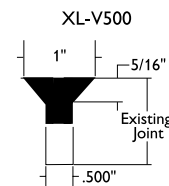
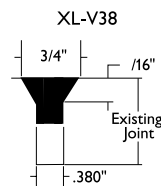
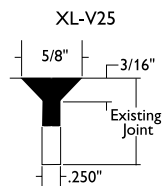
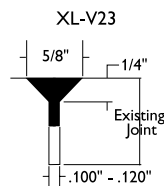
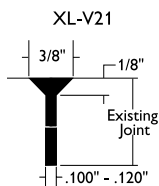

# WHAT MAKES DRILLING WITH A HUSQVARNA CORE DRILL SYSTEM MORE PRODUCTIVE?

Drilling systems that enable you to drill quickly, more ergonomically and adapt to different applications can make you more productive. When developing and improving our drill motors, drill stands and diamond bits we look at the whole system. We analyze every component and process to find out how we can make skilled drilling operators work even more efficiently and effortlessly. More holes drilled per working hour. More production per operator. That's what a Husqvarna core drilling system is designed to do.



## Double the power, Double the versatility

Using innovative high-frequency technology we've designed the Husqvarna DM 700, an 8 hp (5.9 kW) 3-phase core drill motor, that still doesn't weigh more than a 4 hp (2.9 kW) 1-phase motor. In addition, all Husqvarna PRIME™ equipment can be run on both 3-phase and 1-phase, so you can always finish the job with any power available. This is why the Husqvarna DM 700 doesn't only drill efficiently, it also saves you a lot of hassle when carrying and setting up the rig.

## Range Overview

Husqvarna drill systems consist of powerful drill motors and sturdy stands. Power options are available from the electric handheld 2.3 hp DM 220 to the hydraulic 12.5 hp DM 406 H. Recommended maximum drilling diameters range from 1 in to 24 in. For the highest production rate, choose the system/systems optimal for your kind of operation.

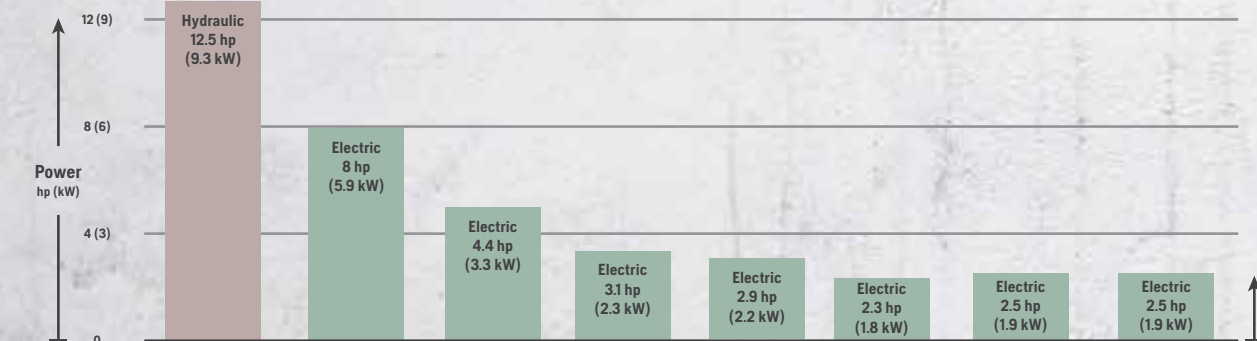





Finishing a job you can feel proud of is often what turns a normal day at work into a great day at work. To accomplish this, you need a tool that matches your ability and professionalism. A tool that lets you work quickly, carefully and effectively. A working tool that won't let you down.

Our new drill motors are hard-wearing and efficient, due to a new motor that marries power and performance with real reliability. In addition the tough, high-quality casing means these drills are built to perform in any environment. The DM 400 and DM 430 are equipped with plenty of features that will make a difference to your workday - from how they feel to how they perform.

You can see the difference right away. Compared to previous models, the DM 400 and the DM 430 are a new design and equipped with a tough aluminium case and a carrying handle that doubles as a protective guard. But the changes aren't just on the surface.

Our new range of high frequency PRIME equipment offers outstanding power-to-weight ratio and exceptional performance. You can perform wall sawing, drilling and handheld cutting using the same power source. In short, do more jobs with smaller, lighter equipment with increased productivity.

Flexible power, you can use Husqvarna DM 700 / PP 70 with both 3-phase and 1-phase power. With 1-phase power the system delivers 4 hp on the spindle, making the DM 700 the most powerful 1-phase drill motor on the market. 3-phase power delivers 8 hp at the spindle.

DM 700 is a very powerful & versatile electric drill motor equipped with high frequency PRIME technology. The high power output, low weight, user-friendly setup and intelligent design make the Husqvarna DM 700 suitable for most drilling applications. The spindle speed can be optimized while running.



# Large Motor Core Drill Kits

## Applications

- Developed for construction professionals who need to drill holes in concrete, brick or masonry.

## Benefits

- Plug-n-play drill rigs are designed to be uncomplicated, reliable and user friendly.
- More information on the motors and stands can be found in the pages following.



Core Drill Models	DMS 400	DMS 280
Core Drill Model Breakdown	DM 400 + DS 500	DM 280 + DS 500
Part No. (Anchor Base)	970455301	967980901
Part No. (Anchor Base, Vacuum Plate)	970455302	967980902
Part No. (Anchor Base, Vacuum Plate, Pump)	970455303	967980903

## Technical Specifications

Maximum bit diameter with spacers, in (mm)	16 (400)	14 (355)
Maximum bit diameter without spacer, in (mm)	14 (355)	14 (355)
Power, hp (kW)	4.4 (3.3)	3 (2.4)
Voltage/ampereage, V/amps	115/27	115/20
Speeds	3	3
Travel length, in (mm)	25.5 (648)	25.5 (648)
Spindle speed no load, rpms	420/820/1,250	310/690/1,190
Spindle speed full load, rpms	230/460/720	250/550/950
Rated output, watts	2,300	1,800
Sound pressure level, dB(A)	96	90
Sound power level, dB(A)	110	94
Spindle thread, outer	1-1/4-7	1-1/4-7
Weight, lbs (kg)	84 (38)	86 (39)
Recommended generator size, watts	6,500	5,000

### Recommended Core Bits

Core Bits	B1410, B10, B20, B30, B80, Banner Line	Banner Line
-----------	--	-------------

## Medium Motor Core Drill Kits

### Applications

- Developed for construction professionals who need to drill holes in concrete, brick or masonry.

### Benefits

- Plug-n-play drill rigs are designed to be uncomplicated, reliable and user friendly.
- More information on the motors and stands can be found in the pages following.



Core Drill Models	DMS 280	DMS 240	DMS 180
Core Drill Model Breakdown	DM 280 + DS 800	DM 240 + DS 150	DM 180 + DS 250
Part No. (DS 800 Combo Base, Vac Assembly)	965177232	-	-
Part No.	-	965173601	966916101
Part No. (Anchor Base, Vacuum Plate, Pump)	-	965173606	966916102

### Technical Specifications

Maximum bit diameter with spacers, in (mm)	14 (355)	10 (250)	6 (150)
Maximum bit diameter without spacer, in (mm)	14 (355)	-	-
Power, hp (kW)	3 (2.7)	2.9 (2.2)	2.3 (1.8)
Voltage/ampereage, V/amps	115/20	115/20	115/20
Speeds	3	2	1
Travel length, in (mm)	25.5 (648)	24 (610)	19 (480)
Spindle speed no load, rpms	310/690/1,190	390/890	-
Spindle speed full load, rpms	250/550/950	-	800
Rated output, watts	1,800	1,400	1,000
Sound pressure level, dB(A)	90	89	89
Sound power level, dB(A)	94	102	102
Spindle thread, outer	1-1/4-7	1-1/4-7	1-1/4-7
Weight, lbs (kg)	122 (55)	51 (23)	51 (23)
Recommended generator size, watts	5,000	5,000	3,500

### Recommended Core Bits

Core Bits	Banner Line	Banner Line, Tacti-Drill	Banner Line, Tacti-Drill
-----------	-------------	--------------------------	--------------------------

# Husqvarna DM 406 H

## Applications

- Hydraulic drill motor used to drill reinforced concrete, bricks and other building materials.
- Able to drill holes for waste evacuation pipes, stitch drill as well as drill large openings and deep holes for other channels and pipes.
- Ideal for use with Husqvarna's PP 518 gas or PP 325 E electric power packs.
- Ideal for large diameter holes.

## Benefits

- Six speeds accommodate 2" to 24" diameter bits.
- Two mechanical and three hydraulic gears provide a wide range of RPMs with maximum power and production.
- The hydraulic speed control enables the operator to change spindle speeds while drilling.



CORE DRILLS

Core Drill Model		DM 406 H
Part No. (stand and core bit sold separately)		965158207
Technical Specifications		
Flow requirements	10 GPM @2,000 PSI	
High range motor speed	1,400/980/120	
Recommended bit diameter, high range, in (mm)	1-6 (25-152)	
Low range motor speed	340/230/120	
Recommended bit diameter, low range, in (mm)	6-24 (152-610)	
Weight, lbs (kg)	35 (15.9)	
Spindle thread	1-1/4-7	
Recommended Core Bits		
Core Bits	B1420, B1425, B1430, B20, B30, B80	

# NEW Husqvarna Prime DM 700 & PP 70



2 YEAR  
WARRANTY

## Applications

- Ideal for all core drilling 4" (100 mm) to 24" (600 mm) in reinforced concrete, brick and other building materials.
- Perfect for heavy-duty applications like water drains, ventilation (HVAC), plumbing channels, waste drain pipes, gas supply pipes, manholes and barriers.
- Suitable for applications where easy transportation to and around the job site is required. (PP 70)

## Benefits

- Very powerful drill motor delivering 6,000 W on the spindle (3,000 W on 1-phase).
- 18-step adjustable rpm range ensures optimal speed for all drill bit dimensions.
- The low weight and ergonomic design make it easy to carry and mount.
- Dust-proof, water-cooled motor with minimal service requirements.
- When drilling in steel or difficult materials, the torque boost reduces speed to increase drilling torque.
- Durable, shock-proof design protects the electronics.
- Elgard™ enables drilling at maximum pressure without risk of overload.
- It can connect to both 3- and 1-phase power. (PP 70)



Core Drill & Power Pack Models	DM 700	PP 70
Part No. (DM 700 ONLY. Stand, core bit and power pack sold separately)	970449401	-
Part No. (PP 70 ONLY)	-	967828303

## Technical Specifications

Power 3-phase/1-phase, hp (kW)	8 (5.9)/4 (2.9)	8.7 (6.5)/2-4 (1.5-3)
Voltage 3-phase/1-phase, V	480/230	120-240/200-480
Rated current, amp	-	15
Speeds	18 (2 mechanical, 9 electric)	-
Spindle speed no load, rpm	125/675	-
Spindle speed loaded, rpm	113/608	-
Drill bit diameter with stand, max in (mm)	24 (600)	-
Cooling	-	Water
UNC water coupling	G-1.4"	-
Spindle thread, outer	1-1/4-7"	-
Sound pressure level, dB(A)	98	-
Sound power level, dB(A)	113	-
Weight, lbs (kg)	31 (14)	40 (18)
Recommended minimum size of generator, kW	-	10

## Recommended Core Bits

Core Bits	B1420, B1425, B1430, B20, B30, B80	-
-----------	------------------------------------	---



# Husqvarna DM 430 | DM 400



## Applications

- Drills reinforced concrete, bricks and other building materials.
- Perfect for a variety of applications including water/waste evacuation pipes, openings for ventilation and plumbing, gas supply pipes, barriers, road signs and holes in corners for wall saw openings.
- DM 430 has a higher torque to handle larger holes in hard/reinforced concrete.



## Benefits

- All aluminum body decreases the machine's weight while also increasing its strength.
- Extended motor life enables the machine to work day in and day out compared to others in its class.
- Embedded Fleet connectivity.
- Three-speed gearbox facilitates optimal drilling performance and increases life.
- Equipped with Elgard™, which indicates, via an LED, when the motor is being overloaded. This prevents motor damage and increases product life.
- Smartstart® reduces drill motor RPMs to decrease vibration when starting a hole.



CORE DRILLS

Core Drill Models	DM 430	DM 400
Part No.	970445602	967910303

## Technical Specifications

Maximum bit diameter with stand and spacers, in (mm)	18 (450)	16 (400)
Power, hp (kW)	4.4 (3.3)	4.4 (3.3)
Motor	1-Phase, Electric	1-Phase, Electric
Voltage, V	115	115
Rated output, watts	2,300	2,300
Rated current, amps	27	27
Speeds	3	3
Spindle speed no load, low speed, rpm	250/510/800	420/820/1,250
Spindle speed full load, low speed, rpm	150/300/470	230/460/720
Spindle thread, outer	1-1/4-7	1-1/4-7
UNC water coupling	G 1/4"	G 1/4"
Sound pressure level, dB(A)	96	96
Sound power level, dB(A)	110	110
Weight, lbs (kg)	31 (14.2)	30 (13.5)
Recommended generator size, watts	6,500	6,500

### Recommended Core Bits

Core Bits	B1410, B1420, B1425, B1430, B10, B20, B30, B80	B1410, B10, B20, B30, B80, Banner Line
-----------	--	--



CORE DRILLS

[CLICK HERE TO SEE IT IN ACTION!](#)

# Husqvarna DM 280

## Applications

- Drills reinforced concrete, bricks and other building materials.
- Perfect for a variety of applications including water/waste evacuation pipes, openings for ventilation and plumbing, gas supply pipes, barriers, road signs and holes in corners for wall saw openings.
- DM 430 has a higher torque to handle larger holes in hard/reinforced concrete.

## Benefits

- All aluminum body decreases the machine's weight while also increasing its strength.
- Extended motor life enables the machine to work day in and day out compared to others in its class.
- Embedded Fleet connectivity.
- Three-speed gearbox facilitates optimal drilling performance and increases life.
- Equipped with Elgard™, which indicates, via an LED, when the motor is being overloaded. This prevents motor damage and increases product life.
- Smartstart® reduces drill motor RPMs to decrease vibration when starting a hole.

2 YEAR WARRANTY



## Core Drill Models

DM 280

Part No.

966554104

## Technical Specifications

Maximum bit diameter with stand and spacers, in (mm)	14 (355)
Power, hp (kW)	3 (2.4)
Motor	1-Phase, Electric
Voltage, V	115
Rated output, watts	1,800
Rated current, amps	16
Speeds	3
Spindle speed no load, low speed, rpm	240/530/900
Spindle speed full load, low speed, rpm	170/380/650
Spindle thread, outer	1-1/4-7
UNC water coupling	G 1/4"
Sound pressure level, dB(A)	98
Sound power level, dB(A)	105
Weight, lbs (kg)	31 (14.2)
Recommended generator size, watts	5,000

## Recommended Core Bits

Core Bits

Banner Line



# NEW Husqvarna DM 200



## Applications

- Husqvarna DM 200 is a tough and versatile D-handle drill motor optimised for handheld drilling of holes from 0.9-3 in (25-80 mm).
- The uncomplicated and sturdy design, all-round usability makes it an ideal part of any craftsman's toolkit as well as for rental purposes.
- Delivers top class drilling performance in both wet and dry applications

## Benefits

- Built for years of rough handling and hard work in tough conditions, with oil-bath gear lubrication, aluminium gearbox casing and impact-proof polyamide plastic motor casing to save weight.
- Both the operator and drill motor are protected by an overload clutch, while intelligent engine electronics automatically alerts the operator if the overload threshold is exceeded.
- Equipped with built-in connectivity for communication with the Husqvarna Fleet Services™ system in your smartphone or laptop, enabling you to monitor the actual runtime and utilisation rate, availability and location, service planning and fleet inventory.



## Core Drill Models

Part No.

**DM 200**

970445703

## Technical Specifications

Power, hp (kW)	2.3 (1.7)
Motor	1-phase, electric
Voltage, V	115
Rated output, watts	1,200
Rated current, amps	15
Speeds	2
Spindle speed no load, rpm	1,375/2,800
Spindle speed full load, rpm	835/1,700
Maximum bit diameter with stand, in (mm)	3 (80)
Maximum bit diameter handheld, in (mm)	3 (80)
Spindle thread, inner	5/8-11"
Spindle thread, outer	1.25-7"
UNC water coupling	G 1/4
Sound pressure level, dB(A)	88
Sound power level, dB(A)	99
Weight, lbs (kgs)	11.5 (5.2)
Recommended generator size, watts	5,000

## Recommended Core Bits

Core Bits

Banner Line



# Husqvarna DM 230

## Applications

- The DM 230 can be used for handheld drilling applications up to 4" in diameter. It can be mounted on the DS 150 drill stand for angle drilling applications and drilling holes up to 6" in diameter.
- Used to drill holes for ventilation, plumbing pipes, joints, electrical sockets and telecom cables in reinforced concrete, bricks and other building materials.

## Benefits

- Motor can tolerate and perform effectively in higher ambient temperatures.
- Gearbox and motor alignment have been updated to reduce friction and improve sturdiness.
- Equipped with Elgard™, an indicator that pulses when the machine is overloaded, which provides longer product life.
- Smartstart® reduces drill motor RPMs to decrease vibration when starting a hole.
- Softstart™ slowly increases motor RPMs when starting, which reduces wear on the motor and brushes.
- The 3-speed, water-cooled gearbox provides optimal drilling performance and longer service intervals.
- Designed with a plastic housing, which makes it more durable against drops and daily wear.
- The handle and controls are designed and positioned to further enhance drilling performance and ergonomics.



Core Drill Model	DM 230
Part No.	968411301

## Technical Specifications

Power, hp (kW)	2.3 (2)
Motor	1-Phase, Electric
Voltage, V	115
Rated output, watts	1,200
Rated current, amps	8/15
Speeds	3
Spindle Speed no load, rpm	730/1,700/3,600
Spindle Speed full load, rpm	580/1,400/2,900
Maximum bit diameter with stand, in (mm)	6 (150)
Maximum bit diameter handheld, in (mm)	4 (100)
Spindle thread, inner	5/8-11
Spindle thread, outer	1-1/4-7
UNC water coupling	G 1/4"
Sound pressure level, dB(A)	90
Sound power level, dB(A)	94
Weight, lbs (kg)	15.4 (7)
Recommended generator size, watts	5,000

Recommended Core Bits	
Core Bits	Banner Line

# Husqvarna DM 220

## Applications

- Used for handheld drilling up to 4".
- Mount on DS 250 drills tand to drill holes up to 6" or angle drill.  
Can be used with a vacuum for dust free project.
- Vac port comes standard for dry applications such as drilling bricks, blocks or other building materials.
- Used for wet applications when drilling reinforced concrete.
- Perfect tool for drilling smaller holes for ventilation, plumbing pipes, joints, electrical sockets and telecom cable openings.

## Benefits

- Motor can tolerate and perform effectively in higher ambient temperatures.
- Gearbox and motor alignment have been updated to reduce friction and improve sturdiness.
- Equipped with a LED indicator that shows when the machine is in a vertical or horizontal position and can also be calibrated to help guide the operator while angle drilling.
- The positioning system makes it possible for the operator to focus on drilling while controlling the position of the machine via the LED indicators.
- Softstart™ slowly increases motor RPMs when starting, which reduces wear on the motor and brushes.



Core Drill Model	DM 220
Part No.	966563503

## Technical Specifications

Power, hp (kW)	2.3 (2)
Motor	1-Phase, Electric
Voltage, V	115
Rated output, watts	1,200
Rated current, amps	8/15
Speeds	3
Spindle Speed no load, rpm	900/2,150/4,500
Spindle Speed full load, rpm	500/1,400/2,900
Maximum bit diameter with stand, in (mm)	6 (150)
Maximum bit diameter handheld, in (mm)	4 (100)
Spindle thread, inner	5/8-11
Spindle thread, outer	1-1/4-7
UNC water coupling	G 1/4"
Sound pressure level, dB(A)	90
Sound power level, dB(A)	94
Weight, lbs (kg)	15.4 (7)
Recommended generator size, watts	5,000

Recommended Core Bits	
Core Bits	Banner Line

# Large Core Drill Stands

## Applications

- Drill stand made to support large diameter, heavy-duty drilling applications. (DS 900 & DS 800)
- 42" long, precision ground and plated 2-7/8" square column reduces flex for more accurate drilling. (DS 800 & DS 500)
- Used to drill openings for ventilation, plumbing and stitch drilling with larger holes as well as angle drilling in reinforced concrete, bricks and other building materials.

## Benefits

- Incorporates the 48" column of our wall saws for increased strength and stability. (DS 900)
- Equipped with a carry handle on back support and ergonomic 3-spoke handle. (DS 900 & DS 500)
- Wheel kit can be attached for easy transportation.
- Reinforced base for added rigidity. (DS 800)
- Jack screw is standard and provides stability when ceiling bracing. (DS 800 & DS 500)
- Precision rack and pinion gear system enables smooth operation.
- Quick disconnect enables operator to easily remove or mount drill motor. (DS 900 & DS 500)



Core Stand Models	DS 900	DS 800 Anchor Base	DS 800 Combo Base	DS 500 Anchor Base
Part No. (drill stand)	967301602	965176902	965176901	967968601
Part No. (stand without column)	586905102	965176906 (with roller carriage)	965176905 (with roller carriage)	-

## Technical Specifications

Max drill bit diameter, in (mm)	35 (900) with spacer	24 (600) with spacer	24 (600) with spacer	16 (400) with spacer
Max travel, in (mm)	37 (944)	25.5 (650)	25.5 (650)	25.5 (650)
Tilt angle range	0-60°	0-60° w/angle bracket assembly	0-60° w/angle bracket assembly	0-60° w/angle bracket assembly
Carriage gearbox	1 Speed	1 Speed	1 Speed	1 Speed
Weight, lbs (kg)	70.5 (32)	108 (49) without carriage	108 (49) without carriage	40 (18) without carriage
Recommended equipment	DM 700/406	DM 700/406/430/400	DM 700/406/430/400	DM 430/400/280

## Small Core Drill Stands

### Applications

- Perfect stand for drilling in walls and floors up to 10" in diameter when drilling ventilation channels, plumbing and joints.
- Drills in reinforced concrete, bricks and other building materials.
- Used to angle drill and stitch drill.
- This drill stand can be used with the DM 230 hand drill. (DS 150)
- Drills reinforced concrete, bricks and other building materials up to 6" in diameter. (DS 150)
- Used to angle drill. (DS 150)

### Benefits

- Two versions, 1-speed and 2-speed, are available. Both can be used with most drill motors on the market.
- Light and compact, it is easy to transport and mount the stand. (DS 150)
- Equipped with stabilizing guide rollers for accurate drilling. (DS 150)



Core Stand Models	DS 250 2-SPEED	DS 250 1-SPEED	DS 150
Part No.	966827302	966827304	966827202

### Technical Specifications

Max drill diameter, in (mm)	10 (254)	10 (254)	6 (150)
Max travel, in (mm)	27 (685)	27 (685)	19.5 (495)
Maximum tilt angle	60°	60°	60°
Carriage gearbox	2 Speed	1 Speed	1 Speed
Weight, lbs (kg)	17 (7.7)	16 (5.9)	14 (6.4)
Recommended equipment	DM 220	DM 220	DM 230



# Universal Core Drilling Accessories (Motors)

Accessories		Dust Mgmt
Adapter cord, 20A twist to 15A straight	542173120	
Copper washer for 1-1/4" - 7 spindles	541400568	
Dust Bug 90	590652001	X
Dust Bug 180	590652002	X
Quick disconnect ring for core bits	543052878	
Quick anchor, 1/2" UNC	590685701	
Quick disconnect washer 1-1/4"	542162849	
Quick disconnect washer 5/8"	542162848	
Slurry ring, 3" (includes rubber seal set)	593563001	X
Slurry ring, 5" (includes rubber seal set)	593563002	X
Slurry ring, 7" (includes rubber seal set)	593563003	X
Slurry ring, 9" (includes rubber seal set)	593563004	X
Slurry ring, 11" (includes rubber seal set)	593563005	X
Slurry ring, 13" (includes rubber seal set)	593563006	X
Slurry ring, 3" (D100 Rubber Seal Replacement Set)	593963901	X
Slurry ring, 5" (D150 Rubber Replacement Seal Set)	593963902	X
Slurry ring, 7" (D200 Rubber Replacement Seal Set)	593963903	X
Slurry ring, 9" (D250 Rubber Replacement Seal Set)	593963904	X
Slurry ring, 11" (D300 Rubber Replacement Seal Set)	593963905	X
Slurry ring, 13" (D350 Rubber Replacement Seal Set)	593963906	X
Spindle wrench, 1-5/8" thin style	53119032	
Water feed assembly	582017501	X
Water tank (metal - 4 gallon)	582017401	X
Water tank, PWT 15	506326302	X
Water tank, WT 15	966708302	X
1-1/4"-7, 6" (150mm) extension / Shaft extension T-410006, 6"	541400035	
1-1/4"-7, 12" (300mm) extension / Shaft extension T-420012, 12"	541201737	
1-1/4"-7, 24" (610mm) extension / Shaft extension T-420024, 24"	541404607	
5/8"-11, 6" (150mm) extension / Shaft extension T-415007, 6"	541400066	
5/8"-11, 12" (300mm) extension / Shaft extension T-415012, 12"	541400070	
1-1/4"-7, 5/8"-11 shaft adapter / Threaded shaft adapter T-420415	541201736	
1-1/4"-7, 1/2"-20 shaft adapter / Threaded shaft adapter T-420410	541404608	
5/8"-11, 1/2"-20 shaft adapter / Threaded shaft adapter T-415410	541404609	
5/8"-11, 1-1/4"-7 shaft adapter / Threaded shaft adapter T-415420	541404610	
1/2"-20, 5/8"-11 shaft adapter / Threaded shaft adapter T-410415	541404611	
M-18, 5/8"-11 shaft adapter / Threaded shaft adapter DM100-1	541404612	
M-18, 1-1/4"-7 shaft adapter / Threaded shaft adapter DM100-2	541404613	

CORE DRILLS



Quick disconnect ring



Dust bug



Slurry vacuum rings



WT 15 pressurized water tank



Shaft adapters

## Accessories to Fit Your Stand

Accessories		DS 900	DS 800 Anchor Base	DS 800 Combo Base
Adapter, pyramid style	541401283		X	X
Ammeter (0-30), replacement	506608801		X	X
Anchor base	541403895		X	
Anchor base, vacuum assembly	541400057		X	
Carriage with handle, roller	541401507		X	X
Carriage with handle, slide	541400562		X	X
Column, 48"/400 track, 48" (1.2m)	531113045	X		
Column, extended 79"/400 track, 79" (2.0m)	531113046	X		
Combo base	504539502			X
Combo base, gasket	541201985			X
Combo base, slot gasket	541201981			X
Control panel, ammeter, switch/cord assembly	541404016		X	X
Drill column, 42"	541402574		X	X
Drill column, 60"	541401109		X	X
Drill column, 72"	541401107		X	X
Drill column, 80"	541401105		X	X
Drill column, 120"	541404256		X	X
Motor mount adapter	541400325		X	X
Motor plate spacer, 8"	586879901	X		
Quick disconnect washer 1-1/4"	542162849	X		
Spacer block, 2"	502624801		X	X
Spacer block, 2" with key and bolts	504544201		X	X
Vacuum assembly, combo base	505190201			X
Vacuum pad with gasket	541401932		X	X
Vacuum pump with fittings, anchor base	541401607		X	
Vacuum pump, without fittings	505549502		X	X
Wheel Kit	587088101	X		
3/4" base leveling screw	541403519		X	X

Accessories		DS 500	DS 250	DS 150
Ring adapter, DS 250 2-speed*	581257101		X	
Vacuum palate assembly	597635102	X		
Vacuum plate, gasket	578932101		X	X
Vacuum pump, with fittings	598802701	X	X	X
Wheel kit	582173302	X		
Quick disconnect 2" spacer	579501001	X		

\*Standard with DS 250 1-speed.



DS 500 vacuum plate



DS 800 anchor base



DS 800 combo base



Vacuum pump with fittings



DS 800 spacer blocks

# Dry Core Drilling



CORE DRILLS

Dry Core Drilling	S-Line			A-Line	
	S 36	S 26	S 13	A 1200	A 600
DM 430/400		DB ✓		+	+
DM 280		DB ✓		+	+
DM 230		DEA/DB ✓		+	+
DM 220		DB ✓		+	+

✓ Attached to machine + Part of solution **DB**-Dust Bug **DEA** - Dust Extraction Attachment

## Dust Bug 90 & 180

Dust bugs help facilitate dust collection when dry drilling. The dust bugs help capture dust at the source to keep the surrounding area cleaner.



Name	Application	Recommended Vacuum	Part No.
Dust Bug 90	Drilling up to 3 1/4"	S 13 or larger	590652001
Dust Bug 180	Drilling up to 6 3/4"	W 70 P - Wet	590652002

# Wet Core Drilling



Wet Core Drilling	W-Line	Water Supply
	W 70 P/W 70/W 250 P	
DM 650	Slurry Collector ✓ / Slurry Collector+	WT 15 / PWT 15
DM 400/430	Slurry Collector ✓ / Slurry Collector+	WT 15 / PWT 15
DM 280	Slurry Collector ✓ / Slurry Collector+	WT 15 / PWT 15
DM 230	Slurry Collector ✓ / Slurry Collector+	WT 15 / PWT 15
DM 220	Slurry Collector ✓ / Slurry Collector+	WT 15 / PWT 15

✓ Attached to machine + Part of solution

## Slurry Rings

Product Description	Part Number
Slurry Rings 3" (includes rubber seal set)	593563001
Slurry Rings 5" (includes rubber seal set)	593563002
Slurry Rings 7" (includes rubber seal set)	593563003
Slurry Rings 9" (includes rubber seal set)	593563004
Slurry Rings 11" (includes rubber seal set)	593563005
Slurry Rings 13" (includes rubber seal set)	593563006



Slurry Ring 3"



Slurry Ring 5"



Slurry Ring 7"



Slurry Ring 9"



Slurry Ring 11"



# Core Bit Segment Shapes

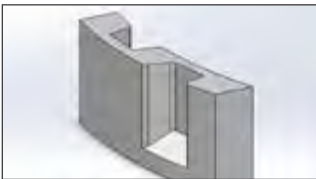

**Z-EDGE**

B1410 & B10



**ROOF TOP**

B1420



**STRAIGHT**

B1425, B1430, B20, B30, B80



**TURBO**

Tacti-drill B10

SEGMENT TYPE	Z-EDGE	ROOF TOP	STRAIGHT			TURBO
MATERIAL	B1410	B1420	B1425	B1430	VARI-DRILL B80	TACTI-DRILL B10
	VARI-DRILL B10		BANNER LINE® VARI-DRILL B20	VARI-DRILL B30		
HIGHLY REINFORCED CONCRETE	● ● ●	● ●	● ●	●	-	● ●
REINFORCED CONCRETE	● ● ●	● ●	● ●	●	-	● ●
HARD AGGREGATE CONCRETE	● ● ●	● ● ●	● ● ●	● ● ●	-	●
ASPHALT	●	●	● ●	● ●	● ● ●	●

● ● ● = Optimal ● ● = Good ● = Acceptable - = Not recommended

GOLD

SILVER

BRONZE

# Diamond Core Bits for Core Drilling

## Elite-Drill B1400 Series

### PROFESSIONAL BITS

- B1410 (Z-Edge): faster drilling in flint, chert and hard aggregate with high steel reinforcement.
- B1420 (Roof Top): fast drilling with a longer life in flint and hard aggregate with high steel reinforcement.
- B1425 (Straight): fast drilling with a longer life in flint and hard aggregate with high steel reinforcement.
- B1430 (Straight): long life in medium to hard concrete with medium to high reinforcement.



#### B1400 | Wet Cutting

Sizes - Inches (mm)	B1410 Part No.	B1420 Part No.	B1425 Part No.	B1430 Part No.
1" (25)	-	-	593948401	-
1.125" (29)	-	-	593948402	-
1.25" (32)	-	-	593948403	-
1.5" (38)	-	-	593948404	-
1.75" (45)	-	-	593948405	-
1.875" (48)	-	-	593948406	-
2" (51)	593069801	586669202	592880601	592880701
2.5" (64)	593069802	586669404	592880602	592880702
3" (76)	593069803	586328505	592880603	592880703
3.5" (89)	593069804	587635304	592880604	592880704
4" (102)	593069805	586328602	592880605	592880705
4.25" (108)	593069806	587635401	592880606	592880706
4.5" (114)	593069807	587635501	592880607	592880707
5" (127)	593069808	586328701	592880608	592880708
6" (152)	593069809	586328801	592880609	592880709
7" (178)	593069810	587494201	592880610	592880710
8" (203)	593069811	587494401	592880611	592880711
9" (229)	593069812	587495301	592880612	592880712
10" (254)	593069813	587513701	592880613	592880713
12" (305)	593069814	587513801	592880614	592880714
14" (356)	593069815	587514001	593070001	593070101

Total segment height for this series is .400" (.300" diamond depth; .100" segment base)

**B1410 | IMPROVED PERFORMANCE IN HARD ROCK, GRANITE & RIVER ROCK APPLICATIONS!**

# Diamond Core Bits for Core Drilling

## Elite-Drill B1400 Crown Bit Series

### PROFESSIONAL BITS

- B1410: flint, chert and hard aggregate with high steel reinforcement.
- B1420: flint, chert and other hard aggregates with steel reinforcement.



#### B1400 | Wet Cutting | Laser Welded

Sizes - Inches (mm)	B1410 Threads Part No.	B1420 Threads Part No.	B1425 Threads Part No.	B1430 Threads Part No.
0.5" (13)	593248001	-	542788309	-
0.625" (16)	593248101	-	542788191	-
0.75" (19)	593248201	593248901	542788339	542788318
0.875" (22)	593248301	593249001	542788340	542788319
1" (25)	593248401	593249101	542788190	542788320
1.125" (29)	593248501	593249301	542788341	542788321
1.25" (32)	593248601	593249401	542788342	542788322
1.375" (35)	593248701	593249501	542788343	542788323
1.5" (38)	593248801	593249601	542788344	542788324
1.625" (41)	-	593249701	-	542788336
1.75" (45)	-	593249801	-	542788337
1.875" (48)	-	593249901	-	542788338

Total segment height for this series is .400" (.300" diamond depth, .100" segment base)

# Diamond Core Bits for Core Drilling

## Elite-Drill B1400 Extended Core Travel Series PROFESSIONAL BITS

- B1420: fast drilling with a longer life in flint and hard aggregate with high steel reinforcement.
- B1425: fast drilling in flint concrete with or without steel reinforcement.
- Core bit lengths not listed cost 10% more than the list price of the next longest listed core travel.



### B1400 Extended Core Travel | Wet Cutting

Sizes - Inches (mm)	24" B1420 Part No.	36" B1420 Part No.	48" B1420 Part No.
0.5" (13)	596242701	596242703	596232301
0.625" (16)	596242702	596242704	596242705
0.75" (19)	542788533	501279501	596242706
0.875" (22)	542788534	542788417	596242707

Total segment height for this series is .400" (.300" diamond depth; .100" segment base)

### B1400 Extended Core Travel | Wet Cutting

Sizes - Inches (mm)	24" B1425 Part No.	36" B1425 Part No.	48" B1425 Part No.
1" (25)	596038401	596137001	596141301
1.125" (29)	596038402	596137002	596141302
1.25" (32)	596038403	596137003	596141303
1.375" (35)	596038404	596137004	596141304
1.5" (38)	595026801	596137005	595026901
1.75" (45)	596038405	596137006	596141305
1.875" (48)	596038406	596137007	596141306
2" (51)	596038407	596137008	594730301
2.25" (57)	596038408	596137009	596141307
2.5" (64)	596038409	594956501	594956502
2.75" (70)	596038410	596137010	596141308
3" (76)	596038411	594956503	594956504
3.25" (83)	596038412	596137011	596141309
3.5" (89)	596038413	594956505	594956506
4" (102)	596038414	596137012	596141310
4.25" (108)	596038415	596137013	596141311
4.5" (114)	594956507	594956508	594956509
5" (127)	596038416	596137014	594956510
5.5" (140)	596038417	596137015	596141312
6" (152)	596038418	594956511	594956512
6.25" (158)	596038419	596137016	596141313
7" (178)	596038420	594738101	596141314
8" (203)	594077001	596137017	596141315
9" (229)	594956516	594956517	594956518
10" (254)	596038421	596137018	596141316
11" (280)	596038422	596137019	596141317
12" (305)	596038423	596137020	596141318
13" (330)	596038424	596137021	596141319
14" (356)	596038425	596137022	596141320

Total segment height for this series is .400" (.300" diamond depth; .100" segment base)



# Diamond Core Bits for Core Drilling

## Vari-Drill Series

### PROFESSIONAL BITS



- B10 (Z-Edge): turbo core bit for highly reinforced concrete.
- B20 (Straight): longer life in flint and hard aggregate with high steel reinforcement.
- B30 (Straight): longer life in medium to hard concrete with medium to high steel reinforcement.
- B80 (Straight): longest life in asphalt and soft/abrasive concrete.
- B80 Prestress (Straight): narrow spacing for prestressed concrete.

#### Vari-Drill | Wet Cutting

Sizes - Inches (mm)	B10 Part No.	B20 Part No.	B30 Part No.	B80 Part No.	B80 Prestress Part No.
1" (25)	-	593947801	-	-	-
1.125" (29)	-	593947802	-	-	-
1.25" (32)	-	593947803	-	-	-
1.5" (38)	-	593947804	-	-	-
1.75" (45)	-	593947805	-	-	-
1.875" (48)	-	593947806	-	-	-
2" (51)	592880801	592880901	592881001	541060145	593070202
2.25" (57)	592880802	592880902	592881002	541060146	593980501
2.5" (64)	592880803	592880903	592881003	541060147	593070203
2.75" (70)	592880804	592880904	592881004	541060148	593980502
3" (76)	592880805	592880905	592881005	541060149	593070204
3.25" (83)	-	-	-	-	593980503
3.5" (89)	592880806	592880906	592881006	541060151	593070205
4" (102)	592880807	592880907	592881007	541060152	593070206
4.25" (108)	592880808	592880908	592881008	541060153	593980504
4.5" (114)	592880809	592880909	592881009	541060154	593980505
5" (127)	592880810	592880910	592881010	541060155	593070207
5.5" (140)	592880811	592880911	592881011	541060156	593980506
6" (152)	592880812	592880912	592881012	541060157	593070208
6.25" (158)	592880813	592880913	592881013	541060158	593980507
7" (178)	592880814	592880914	592881014	541060160	593980508
8" (203)	592880815	592880915	592881015	541060161	593980509
9" (229)	592880816	592880916	592881016	541060162	593980510
10" (254)	592880817	592880917	592881017	541060163	593980511
11" (279)	592880818	592880918	592881018	541060164	-
12" (305)	592880819	592880919	592881019	541060165	593980512
13" (330)	592880820	592880920	592881020	-	593980513
14" (356)	593070201	592880921	592881021	-	593980514

Total segment height for this series is .400" (.300" diamond depth, .100" segment base)

# Diamond Core Bits for Core Drilling

## Vari-Drill Extended Core Travel Series PROFESSIONAL BITS

- BannerLine: General purpose drilling of concrete with soft to hard aggregate and light to medium steel reinforcing, masonry, brick, granite, marble, stone.
- B10: Z-EDGE core bit for highly reinforced concrete.
- B30: longer life in medium to hard concrete with medium to high steel reinforcement.
- Core bit lengths not listed cost 10% more than the list price of the next longest listed core travel.



### Vari-Drill Extended Core Travel | Wet Cutting

Sizes - Inches (mm)	24" BannerLine Part No.
0.5" (13)	589687401
0.625" (16)	589687601
0.75" (19)	542786967
0.875" (22)	589687701
1" (25)	587751201
1.125" (29)	542788366
1.25" (32)	542788021
1.375" (35)	589687801
1.5" (38)	542787555
1.75" (45)	589688201
1.875" (48)	589317301

Total segment height for this series is .400" (.300" diamond depth, .100" segment base)

# Diamond Core Bits for Core Drilling

## Vari-Drill Extended Core Travel Series

### PROFESSIONAL BITS



- BannerLine: General purpose drilling of concrete with soft to hard aggregate and light to medium steel reinforcing, masonry, brick, granite, marble, stone.
- B10: Z-EDGE core bit for highly reinforced concrete.
- B30: longer life in medium to hard concrete with medium to high steel reinforcement.
- Core bit lengths not listed cost 10% more than the list price of the next longest listed core travel.

#### Vari-Drill Extended Core Travel | Wet Cutting

Sizes - Inches (mm)	24" B10 Part No.	24" B30 Part No.	36" B30 Part No.	48" B30 Part No.
2" (51)	594101501	-	594101801	596201201
2.25" (57)	595934201	-	595958101	596201202
2.5" (64)	595934202	-	595958102	596201203
2.75" (70)	595934203	-	595958103	596201204
3" (76)	594101502	-	594101802	594005401
3.25" (83)	595934204	-	595958104	596201205
3.5" (89)	594101503	-	594101803	596201206
4" (102)	594101504	-	594101804	596201207
4.25" (108)	595934205	-	595958105	596201208
4.5" (114)	595934206	-	595958106	596201209
5" (127)	594101505	-	594101805	596201210
5.5" (140)	595934207	-	595958107	596201211
6" (152)	594101506	-	594101806	596201212
6.25" (158)	595934208	-	595958108	596201213
7" (178)	595934209	-	595958109	596201214
8" (203)	595934210	-	595958110	596201215
9" (229)	595934211	-	595958111	596201216
10" (254)	595934212	-	595958112	596201217
11" (279)	595934213	-	595958113	596201218
12" (305)	595934214	-	595958114	596201219
13" (330)	595934215	-	595958115	596201220
14" (355)	595934216	-	595958116	596201221
16"	-	593954909	-	-
18"	-	593954910	-	-
20"	-	593954911	-	-
22"	-	593954912	-	-
24"	-	593954913	-	-
26"	-	593954914	-	-
28"	-	593954915	-	-
30"	-	593954916	-	-
34"	-	593954917	-	-
36"	-	593954918	542775860	-
42"	-	-	593070310	-
48"	-	-	593070311	-

Total segment height for this series is .400" (.300" diamond depth; .100" segment base)

# Diamond Core Bits for Core Drilling

## Banner Line® PROFESSIONAL BITS

- Banner Line (Straight): general purpose drilling of concrete with soft to hard aggregate and light to medium steel reinforcing, masonry, brick, granite, marble, stone.
- 3/8" to 1.5" bits have a 5/8"-11 adapter. Bits 1-5/8" and above have a 1.25" - 7 thread adapter.



### Banner Line® | Wet Cutting

Sizes - Inches (mm)	Part Number
0.375" (10)	542786634*
0.5" (13)	542786635*
0.625" (16)	542786636*
0.75" (19)	542780100*
0.875" (22)	542780101*
1" (25)	542780102
1.125" (29)	542780103
1.25" (32)	542780104
1.375" (35)	542780105
1.5" (38)	542780106
1.75" (45)	542780107
1.875" (48)	542780108
2" (51)	542780109
2.25" (57)	542780110
2.5" (64)	542780111
2.75" (70)	542780112
3" (76.2)	542780113
3.25" (83)	542780114
3.5" (89)	542780115
4" (102)	542780116
4.25" (108)	542780117
4.5" (114)	542780118
5" (127)	542780119
5.5" (140)	542780120
6" (152)	542780121
6.25" (158)	542780122
7" (178)	542780123
8" (203)	542780124
9" (229)	542780125
10" (254)	542780126
11" (280)	542780127
12" (305)	542780128
13" (330)	542780129
14" (356)	542780130

Total segment height for this series is .400" (.200" diamond depth; .100" segment base)



# Diamond Core Bits for Core Drilling

## Tacti-Drill B10 Series

### GENERAL PURPOSE BITS

- B10 (Turbo): Fast drilling in concrete with or without steel reinforcement, brick, block, stone.



#### B10 | Wet Cutting

Sizes - Inches (mm)	Part Number
2" (51)	593070601
2.5" (63)	593070602
3" (76)	593070603
3.5" (89)	593070604
4" (100)	593070605
5" (127)	593070606
6" (152)	593070607
8" (203)	593070608
10" (254)	593070609
12" (305)	593070610

Total segment height for this series is .300" (.200" diamond depth; .100" segment base)

#### Shaft Extensions

Model	Thread	Length in (mm)	Part Number
T-410006	1.25" - 7	6 (152)	541400067
T-415007	0.625" - 11	6 (152)	541400066
T-415012	0.625" - 11	12 (305)	541400070
T-420012	1.25" - 7	12 (305)	541201737
T420024	1.25" - 7	24 (600)	541404607

#### Threaded Shaft Extensions

Model	Female	Male	Part Number
T-420410	1.25" - 7	0.5" - 20	541404608
T-420415	1.25" - 7	0.625" - 11	541201736
T-415410	0.625" - 11	0.5" - 20	541404609
T-415420	0.625" - 11	1.25" - 7	541404610
T-410415	0.5" - 20	0.625" - 11	541404611
DM100-1	M-18	0.625" - 11	541404612
DM100-2	M-18	1.25" - 7	541404613

#### Three-Piece Expansion Adapter for Open End Bits

Sizes - Inches (mm)	Part Number
1.25" (32)	542751273
2" (51)	542751274
2.5" (64)	542751267
3" (76)	542751276
4" (100)	542751277
4.5" (114)	542751278
6 (152)	542751279

# Diamond Core Bits for Core Drilling

## Threaded Crown Bits & Extensions

### PROFESSIONAL BITS

- Increase drilling depth capabilities
- Available in bit diameters of 1"-6" and comes standard with a 14" core travel
- Tube extensions can be purchased in lengths of 12" and 24" for deeper drilling.  
Available only in Elite-Drill 1430 specification
- 12-gauge tubing for bits 3" in diameter and smaller. 11-gauge tubing for bits larger than 3".  
Threaded connections are 4 TPI
- .125" wall recommended for drilling up to 20' deep

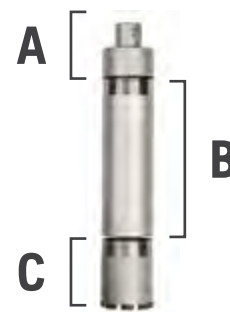

### Professional | 1.25" - 7 Adapter + 12" Tube+

Sizes - Inches (mm)	0.125" Wall Tubing Part No.	0.188" Wall Tubing Part No.
1" (25) - 8 TPI	588419701	
1.25" (32) - 8 TPI	588419801	
1.5" (38) - 8 TPI	588419901	
2" (51) - 4 TPI	588420001	
2.5" (64) - 4 TPI	588420101	
3" (77) - 4 TPI	588420301	
3.5" (89) - 4 TPI	588420401	
4" (100) - 4 TPI	588420501	
4.5" (114) - 4 TPI		588420601
5" (127) - 4 TPI		588420701
6" (152) - 4 TPI		588420801

Total segment height for this series is .400" (.300" diamond depth; .100" segment base)

Adapters	C	A	B	B	B
Sizes - Inches (mm)	Crown Part No.	Replacement Part No.	1ft Tube Part No.	2 ft Tube Part No.	4 ft Tube Part No.
1" (25)	587794601	587817201	587815601	587815701	587815801
1.25" (32)	587794602	587817202	587815602	587815702	587815802
1.5" (38)	587794603	587817203	587815603	587815703	587815803
2" (51)	587794604	587817204	587815604	587815704	587815804
2.5" (64)	587794605	587817205	587815605	587815705	587815805
3" (77)	587794606	587817206	587815606	587815706	587815806
3.5" (89)	587794607	587817207	587815607	587815707	587815807
4" (100)	587794608	587817208	587815608	587815708	587815808
4.5" (114)	587820901	587822201	587822001	587821001	587822101
5" (127)	587820902	587822202	587822002	587821002	587822102
6" (152)	587820903	587822203	587822003	587821003	587822103

# Diamond Core Bits for Core Drilling

## Dri Vacuum Drill Bits™

### GENERAL PURPOSE, MASONRY BITS

- DR15: Dry drill through bricks
- DR18: Dry drill through blocks
- 10" (254 mm) core travel



#### Dri Vacuum | Dry Drilling

Sizes - Inches (mm)	(5/8"-11) DR15 Part No.	(1.25"-7) DR15 Part No.	(5/8"-11) DR18 Part No.	(1.25"-11) DR18 Part No.
1" (25)	594947101	542788330	595869401	542788352
1.25" (32)	594979101	542788331	595869402	542788353
1.5" (38)	594060001	542788332	595869403	542788354
1.75" (44)	594060002	542788263	595869404	542788355
2" (51)	594060003	542788264	595869405	542788356
2.5" (64)	594060005	542788265	595869407	542788357
3" (77)	594060006	542788266	595869408	542788358
3.5" (89)	594060007	542788267	595869409	542788359
4" (100)	594060008	542788268	595869410	542788360
4.5" (114)	594060009	542788269	595869411	542788361
5" (127)	594060010	542788270	595869412	542788362
6" (152)	594060011	542788271	595869413	542788363

Total segment height for this series is .400" (.300" diamond depth; .100" segment base)

## Turbo Gold Thin-Wall Core Bits

### GRANITE, MARBLE & PORCELAIN BITS

- Drilling granite, marble and porcelain
- 5/8 - 11 thread, 3" overall length



#### Turbo Gold Thin-Wall | Wet Cutting

Sizes - Inches (mm)	Part Number
1" (25)	542786066
1.25" (32)	542786067
1.375" (35)	542786068
1.5" (38)	542786069
2" (51)	542786070

## Diamond Core Bits for Core Drilling

### Banner Line® Handheld GENERAL PURPOSE BITS

- Banner Line® Handheld general purpose drilling with a handheld drill
- Thin-wall tubing makes them lightweight and easy to control
- 5/8"-11 thread | 10" core length



#### Banner Line

Sizes - Inches (mm)	Part Number
1" (25)	542751170
1.25" (32)	542751172
1.5" (38)	542751174
1.625" (41)	542751175
1.75" (44)	542751176
2" (51)	542751178
2.25" (57)	542784451
2.5" (63)	542784452
2.75" (70)	542784453
3" (76)	542784454
3.5" (89)	542784456
4" (100)	542784457

Total segment height for this series is .200" (.200" diamond depth, .100" segment base)

### Diamond Bits for Porcelain & Tile GENERAL PURPOSE BITS

- Drilling of small openings for fasteners in porcelain and tiled areas, natural and engineered stone on the market
- 3/8" diameter solid shank. The drilling depth is 1.25"



#### Diamond Bits | Wet Cutting

Sizes - Inches (mm)	Part Number
5/32 (4)	542761285
3/16 (5)	542761286
1/4 (6)	542761287
5/16 (8)	542761288
3/8 (10)	542761289
1/2 (12)	542761290
9/16 (14)	542761438



# Diamond Core Bits for Core Drilling

## Dri Bit™ for Tile

### GENERAL PURPOSE BITS

- Used with a standard electric hand drill for soft to medium-hard ceramic tile and stone
- The drilling depth is 1.25"



#### Dri Bit | Dry or Wet Cutting

Sizes - Inches (mm)	Part Number
1" (25)	542761294
1.125" (29)	542761295
1.25" (32)	542761296
1.375" (35)	542761297
1.5" (38)	542761298
1.625" (43)	542761299
1.75" (44)	542761300
2" (51)	542761301

## Segmented Bit

### GRANITE & MARBLE BITS

- Drilling of granite and marble faucet openings in countertops, vanities and general slab drilling
- The segment height is .200", 5/8 - 11 thread, 4" overall length



#### Segmented Bits | Dry Cutting

Sizes - Inches (mm)	Part Number
1" (25)	542761358
1.125" (29)	542761359
1.25" (32)	542761360
1.375" (35)	542761361
1.5" (38)	542761362
1.625" (43)	542761363
1.75" (44)	542761364
1.875" (47)	542761365
2" (51)	542761366
2.25" (57)	542761367
3" (76)	542761368
4" (102)	542761369

# Diamond Core Bits for Core Drilling

## Non-Coring Bits for Stone

### GRANITE & MARBLE BITS

- Drilling of granite and marble faucet openings in countertops, vanities and general slab drilling
- The segment height is .200", 5/8 - 11 thread, 4" overall length



#### Non-Coring Bits | Wet Cutting

Sizes - Inches (mm)	Part Number
0.25" (6)	542761336
0.625" (10)	542761337
0.5" (13)	542761338

# THE FORMULA FOR UNBEATABLE PRODUCTION RATES NOW HAS A BRAND NEW LOOK

Preparing, grinding and polishing of concrete floors as well as repairing and polishing of terrazzo and other natural stone, are demanding jobs. Our mission is to enable you to perform at your maximum potential by providing you with a system that outperforms any competition. We have recently enhanced our line with an all new range of large floor grinders, because everyday challenges need concrete answers. These robust, compact grinders are designed and engineered to handle everyday challenges with confidence, power and an unmistakable sense of ease. Letting you focus on your work.



## Husqvarna Fleet Services

Husqvarna Fleet Services™ is a digital, cloud-based asset management service that gathers and presents key machine data such as run-time, location, and service interval alerts. Machine sensors are either embedded or retrofitted to the exterior of the machine. Embedded machines, like the PG 830 RC, even present valuable machine health data like machine overload via the service's Operation Insights module.  
(Only on large grinders PG 830 - PG 540)

## Range Overview

The range of Husqvarna floor grinders currently consists of seven models with grinding widths from 11 in to 32 in, 4 hp to 22 hp power and weighing from 190 to 970 lbs. You can always find a Husqvarna PG model for your project.

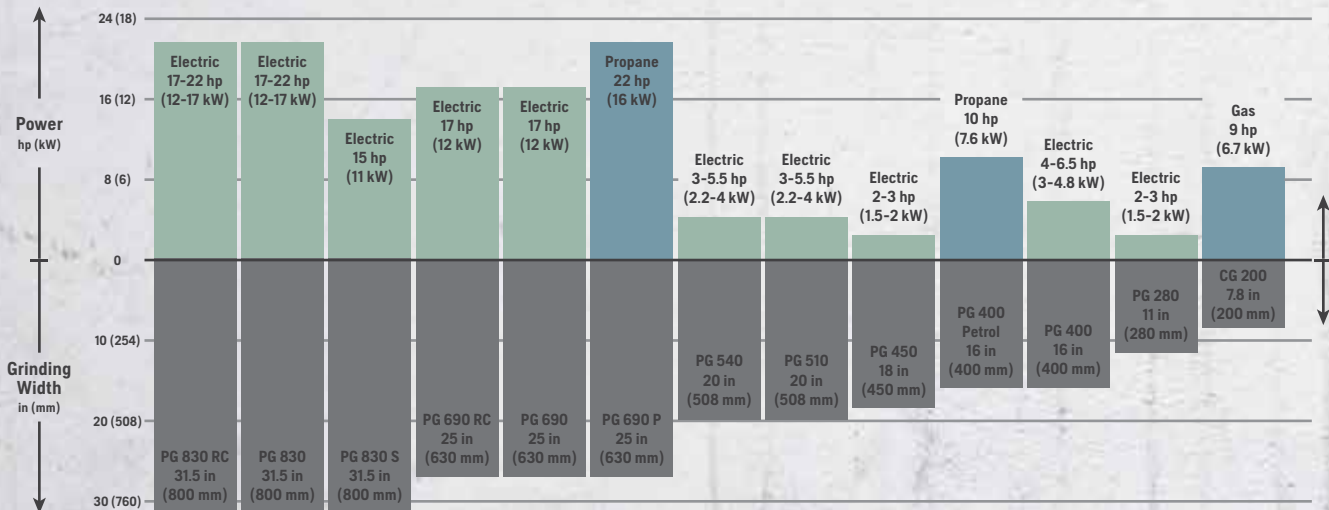





**High performance. Sealed reliability. Intuitive user-friendliness -**

The all new Husqvarna range of floor grinders means business. These robust, compact grinders are designed and engineered to handle everyday challenges with confidence, power and an unmistakable sense of ease. Letting you focus on your work. More powerful than ever, the new range of Husqvarna grinders delivers outstanding performance in all conditions. This means you can get the job done faster and with higher precision. [Learn more at concreteanswers.husqvarnacp.com](https://concreteanswers.husqvarnacp.com)

**Remote Control** - The self-operating, wireless remote controlled Husqvarna PG 830 RC and PG 690 RC enables significantly higher productivity and even better work result together with more ergonomic operation and transport.

**Husqvarna HiPERFLOOR®** - A method for mechanical grinding, chemically treating and polishing of concrete floors. The result is a floor with spectacular reflective qualities as well as increased hardness and durability.

**Redi-lock® tool system** - For easy change of diamond tooling. No tools are needed when changing settings or making adjustments. Standard on all Husqvarna PG models.

**Convenient edge grinding** - The single-disc Husqvarna PG 280 grinder is conveniently equipped with left/right edge grinding functionality as standard.

# Husqvarna PG 830 RC



## Applications

- Large industrial and commercial size projects.
- Remote control grinder increases productivity vs. push grinder on removal, grinding, and polishing concrete, natural stone, and terrazzo surfaces.
- HIPERFLOOR®, wet or dry applications

## Benefits

- Husqvarna's unique Dual Drive Technology™ has now even higher disc speed capabilities. It enables you to individually control the speed and direction of the disc rotation and the speed and direction of the grinding head.
- Sealed grinding head with 1000 hrs service interval. No dust or water can intrude to damage components.
- Low maintenance, smooth operation due to the re-designed Dual Drive Technology™ transmission, fully sealed against dust. Self lubricating drive chain.
- Up to 40% productivity increase when using a remote controlled PG floor grinder. More grinding hours per day since you can operate and prepare next steps simultaneously.



Surface Preparation Model	PG 830 RC
Part No. (3 x 220 V - 50 A)	967977904
Part No. (3 x 480 V - 30 A)	967977902

## Technical Specifications

Rated input power, hp (kW)	17-22 (12.5-16.5)
Voltage, V	200-480
Rated current, A	30/50
Power supply	3-phase
Grinding width, in (mm)	31.5 (800)
Grinding disc, in (mm)	3 x 10.5 (3 x 270)
Grinding pressure total, lbs (kgs)	666 (302)
Grinding pressure with weights, lbs (kgs)	571-798 (259-362)
Grinding disc speed, rpm	421-1,403
Direction of rotation	Dual Drive
Transport dimensions, in (mm) (LxWxH)	61 x 32.7 x 45.1 (1,550 x 830 x 1,146)
Weight, lbs (kgs)	1,318 (598)

Features	
Remote control	Yes
Battery power transportation	Yes
Integrated weights	Optional
LED lights	Optional
Connectivity BLEM/Fleet option	Yes/Yes
USB charger	Yes



# Husqvarna PG 830



## Applications

- Powerful choice for users who prefer non-motorized drive.
- Large industrial and commercial size removal, grinding, and polishing concrete, natural stone, and terrazzo surfaces.
- HIPERFLOOR®, wet or dry applications

## Benefits

- Husqvarna's unique Dual Drive Technology™ has now even higher disc speed capabilities. It enables you to individually control the speed and direction of the disc rotation and the speed and direction of the grinding head.
- Sealed grinding head with 1000 hrs service interval. No dust or water can intrude to damage components.
- Dust sealed electrical cabinet with external cooling technology.
- Re-designed Dual Drive Technology™ transmission, fully sealed against dust. Self lubricating drive chain.
- The optional weights are a must have for every professional grinder, as they allow adjustment of grinding pressure in three pre-set positions. They also make tilting the machine that much easier.



Surface Preparation Model	PG 830
Part No. (3 x 220 V - 50 A)	967977804
Part No. (3 x 480 V - 30 A)	967977802

## Technical Specifications

Rated input power, hp (kW)	17-22 (12.5-16.5)
Voltage, V	200-480
Rated current, A	30/50
Power supply	3-phase
Grinding width, in (mm)	31.5 (800)
Grinding disc, in (mm)	3 x 10.5 (3 x 270)
Grinding pressure total, lbs (kgs)	635 (288)
Grinding pressure with weights, lbs (kgs)	540-767 (245-348)
Grinding disc speed, rpm	421-1,403
Direction of rotation	Dual Drive
Transport dimensions, in (mm) (LxWxH)	61 x 32.7 x 45.1 (1,550 x 830 x 1,146)
Weight, lbs (kgs)	1,226 (556)

## Features

Remote control	No
Battery power transportation	No
Integrated weights	Optional
LED lights	Optional
Connectivity BLEM/Fleet option	No/Yes
USB charger	Yes

# Husqvarna PG 830 S



## Applications

- Single-motor version with focus on core grinding performance.
- Good choice for efficient removal/grinding concrete, natural stone or terrazzo in large industrial/commercial jobsites.
- Wet and dry applications

## Benefits

- Sealed grinding head with 1000 hrs service interval. No dust or water can intrude to damage components.
- The optional weights are a must have for every professional grinder, as they allow adjustment of grinding pressure in three pre-set positions. They also make tilting the machine that much easier.
- Dust sealed electrical cabinet with external cooling technology.
- The control panels in the new range are completely redesigned to offer more control and feedback, even with gloves on.
- Husqvarna Fleet Services™ is a digital, cloud-based asset management service that gathers and presents key machine data. Machine sensors are either embedded or retrofitted to the exterior of the machine.
- Adjustable handle for better ergonomics.



SURFACE PREPARATION

Surface Preparation Model	PG 830 S
Part No. (3 x 220 V - 50 A)	967977704
Part No. (3 x 480 V - 30 A)	967977702

## Technical Specifications

Rated input power, hp (kW)	15 (11)
Voltage, V	200-480
Rated current, A	30/50
Power supply	3-phase
Grinding width, in (mm)	31.5 (800)
Grinding disc, in (mm)	3 x 10.5 (3 x 270)
Grinding pressure total, lbs (kgs)	524 (238)
Grinding pressure with weights, lbs (kgs)	530-657 (195-298)
Grinding disc speed, rpm	421-1,403
Direction of rotation	Counter Rotation
Transport dimensions, in (mm) (L x W x H)	61 x 32.7 x 45.1 (1,550 x 830 x 1,146)
Weight, lbs (kgs)	1,096 (497)

Features	
Remote control	No
Battery power transportation	No
Integrated weights	Optional
LED lights	No
Connectivity BLEM/Fleet option	No/Yes
USB charger	No

# Husqvarna PG 690 Propane



## Applications

- Propane option for large outdoor concrete slabs.
- Large industrial and commercial size removal, grinding, and polishing concrete, natural stone, and terrazzo surfaces.
- HIPERFLOOR®
- Wet or dry applications

## Benefits

- Sealed grinding head with 1000 hrs service interval. No dust or water can intrude to damage components.
- The optional weights are a must have for every professional grinder, as they allow adjustment of grinding pressure in three pre-set positions. They also make tilting the machine that much easier.
- Dust sealed electrical cabinet with external cooling technology.
- Possibility to log operating hours and read the RPM of the machine.
- The new electric fuel injection system cuts fuel consumption and reduces the risk of freezing.
- Combine your grinder with a Husqvarna propane driven dust extractor for maximum productivity.
- New exhaust catalyst makes for even lower emissions.



Surface Preparation Model	PG 690 Propane
Part No. (Kohler PC680)	967980201

## Technical Specifications

Rated input power, hp (kW)	22 (16.5)
Grinding width, in (mm)	25 (630)
Grinding disc, in (mm)	3 x 10.5 (3 x 270)
Grinding pressure total, lbs (kgs)	414 (188)
Grinding pressure with weights, lbs (kgs)	306-538 (139-244)
Grinding disc speed, rpm	730-1,010
Direction of rotation	Head: CW   Disc: CCW
Transport dimensions, in (mm) (L x W x H)	54 x 35 x 58 (1,372 x 889 x 1,473)
Weight, lbs (kgs)	875 (397)

## Features

Remote control	No
Battery power transportation	No
Integrated weights	Optional
LED lights	No
Connectivity BLEM/Fleet option	No/Yes
USB charger	Yes

# Husqvarna PG 690 RC



## Applications

- Large industrial and commercial size projects.
- Remote control grinder increases productivity vs. push grinder on removal, grinding, and polishing concrete, natural stone, and terrazzo surfaces.
- HIPERFLOOR®, wet or dry applications

## Benefits

- Husqvarna's unique Dual Drive Technology™ has now even higher disc speed capabilities. It enables you to individually control the speed and direction of the disc rotation and the speed and direction of the grinding head.
- Sealed grinding head with 1000 hrs service interval. No dust or water can intrude to damage components.
- Low maintenance, smooth operation due to the re-designed Dual Drive Technology™ transmission, fully sealed against dust. Self lubricating drive chain.
- Up to 40% productivity increase when using a remote controlled PG floor grinder. More grinding hours per day since you can operate and prepare next steps simultaneously.



Surface Preparation Model	PG 690 RC
Part No. (3 x 220 V - 50 A)	967977604
Part No. (3 x 480 V - 30 A)	967977602

## Technical Specifications

Rated input power, hp (kW)	17 (12.5)
Voltage, V	200-480
Rated current, A	30/50
Power supply	3-phase
Grinding width, in (mm)	25 (630)
Grinding disc, in (mm)	3 x 10.5 (3 x 270)
Grinding pressure total, lbs (kgs)	534 (242)
Grinding pressure with weights, lbs (kgs)	436-676 (198-307)
Grinding disc speed, rpm	421-1,403
Direction of rotation	Dual Drive
Transport dimensions, in (mm) (L x W x H)	52 x 26.4 x 45.5 (1,320 x 670 x 1,155)
Weight, lbs (kgs)	1,318 (598)

Features	
Remote control	Yes
Battery power transportation	Yes
Integrated weights	Optional
LED lights	Optional
Connectivity BLEM/Fleet option	Yes/Yes
USB charger	Yes

# Husqvarna PG 690



## Applications

- Powerful choice for users who prefer non-motorized drive.
- Large industrial and commercial size removal, grinding, and polishing concrete, natural stone, and terrazzo surfaces.
- HIPERFLOOR®, wet or dry applications

## Benefits

- Husqvarna's unique Dual Drive Technology™ has now even higher disc speed capabilities. It enables you to individually control the speed and direction of the disc rotation and the speed and direction of the grinding head.
- Sealed grinding head with 1000 hrs service interval. No dust or water can intrude to damage components.
- Dust sealed electrical cabinet with external cooling technology.
- Low maintenance, smooth operation due to the re-designed Dual Drive Technology™ transmission, fully sealed against dust. Self lubricating drive chain.
- The optional weights are a must have for every professional grinder, as they allow adjustment of grinding pressure in three pre-set positions. They also make tilting the machine that much easier.



Surface Preparation Model	PG 690
Part No. (3 x 220 V - 50 A)	967977504
Part No. (3 x 480 V - 30 A)	967977502

## Technical Specifications

Rated input power, hp (kW)	17 (12.5)
Voltage, V	200-480
Rated current, A	30/50
Power supply	3-phase
Grinding width, in (mm)	25 (630)
Grinding disc, in (mm)	3 x 10.5 (3 x 270)
Grinding pressure total, lbs (kgs)	503 (228)
Grinding pressure with weights, lbs (kgs)	407-643 (185-292)
Grinding disc speed, rpm	441-1,470
Direction of rotation	Dual Drive
Transport dimensions, in (mm) (L x W x H)	51.2 x 26.4 x 45.3 (1,300 x 670 x 1,150)
Weight, lbs (kgs)	1,107 (502)

Features	
Remote control	No
Battery power transportation	No
Integrated weights	Optional
LED lights	Optional
Connectivity BLEM/Fleet option	No/Yes
USB charger	Yes



# Husqvarna PG 540

## Applications

- Powerful, compact and versatile planetary floor grinder perfect for smaller jobs.
- Suitable for floor prep, grinding and polishing.
- HIPERFLOOR®
- Wet or dry applications

## Benefits

- Sealed grinding head with 1000 hrs service interval. No dust or water can intrude to damage components.
- The optional weights are a must have for every professional grinder, as they allow adjustment of grinding pressure in three pre-set positions. They also make tilting the machine that much easier.
- Dust sealed electrical cabinet with external cooling technology.
- Possibility to log operating hours and read the RPM of the machine.
- Self-adjusting floating cover with brush skirt follows the surface and gives a tight seal to prevent the dust from entering the working environment.
- Fits into most standard cars due to the split-chassis design.



Surface Preparation Model	PG 540
Part No. (1 x 220 V - 30 A)	967977406
Part No. (3 x 200 V - 16 A)	967977404
Part No. (3 x 480 V - 10 A)	967977402

## Technical Specifications

Rated input power, hp (kW)	5.5 (4)
Voltage, V	200-480
Rated current, A	10/16/30
Power supply	1-phase/3-phase
Grinding width, in (mm)	20 (500)
Grinding disc, in (mm)	3 x 9 (3 x 230)
Grinding pressure total, lbs (kgs)	165 (75)
Grinding pressure with weights, lbs (kgs)	179-234 (90-115)
Grinding disc speed, rpm	348-1,160
Direction of rotation	Counter Rotation
Transport dimensions, in (mm) (L x W x H)	40 x 22 x 28.9 (1,015 x 560 x 735)
Weights, lbs (kgs)	169/178 (373/392)

Features	
Integrated weights	Yes
Connectivity BLEM/Fleet option	No/Yes

# Husqvarna PG 510

## Applications

- Three grinding discs and total grinding width of 20 in (515 mm).
- Performs all types of applications such as concrete grinding, coating removal, concrete repair and polishing.
- Ideal as a rental machine for both professional and semi-professional work.

## Benefits

- The grinding head is effectively sealed to keep dust and moisture out. This greatly extends the useful life of the bearings and belts.
- Quick-release couplings allows the grinder head to be separated from the chassis, which can then be easily folded for transport.
- Self-adjusting floating cover with brush skirt follows the surface of the floor and the tight seal prevents dust from entering the working environment.
- The machine has three grinding discs making it suitable for a wide range of applications.
- Fixed speed and no settings required make this a user-friendly machine without a lot of hassle.



Surface Preparation Model	PG 510
Part No. (220-240 V - 15 A)	967932005
Part No. (220-240 V - 15 A)	967932004
Part No. (440-480 V - 7 A)	967932003

## Technical Specifications

Power, hp (kw)	3-5.4 (2.2-4)
Voltage, V	220-240/440-480
Plug type	L6-30/L15-20/L16-20
Rated current, A	15/7
UL & CAS approved	Yes
Power supply	1-phase or 3-phase
Grinding width, in (mm)	20 (515)
Grinding disc, in (mm)	3x9 (230)
Grinding disc segment capacity	18
Grinding pressure total, lbs (kgs)	145-176 (66-80)
Grinding disc speed, rpm	669
Direction of rotation	Counter Rotation
Dimensions, in (mm) (L x W x H)	60 x 21.8 x 37.4 (1,525 x 555 x 950)
Dust port size, in (mm)	2 (51)
Weight, lbs (kgs)	265-293 (120-133)
Recommended generator size (grinder only)	12
Recommended generator size (grinder & vac)	15
Recommended dust extractor size, CFM	285

# Husqvarna PG 450

## Applications

- Performs all types of applications such as concrete grinding, coating removal, concrete repair and polishing.
- Designed for projects under 1,500 sq. ft. (140 m<sup>2</sup>).

## Benefits

- The planetary drive guarantees a flatter surface and can be used to create a HiPERFLOOR® polished concrete surface.
- The self-adjusting floating cover with brush skirt follows the surface and creates a tight seal to prevent dust from entering the surrounding environment.
- The chassis/frame can be separated from the grinding head in less than 30 seconds. The frame folds tightly and can be wheeled around. Having two separate pieces enables the grinder to fit into the trunk of most vehicles.
- The speed and direction are fixed, making for simple operation.
- Redi Lock® is an instant and hassle-free system for changing diamond tooling. Robust system design ensures maximum protection and life of your diamond tools.
- Possibility to log operating hours.



Surface Preparation Model	PG 450
Part No. (110-120 V - 15 A) (50' 10 gauge extension cord included)	967648608
Part No. (220-240 V - 13 A) (50' 10 gauge extension cord included)	967648605

## Technical Specifications

Power, hp (kw)	2/3 (1.49/2.2)
Voltage, V	110-120/220-240
Plug type	L5-15/L6-20
Rated current, A	13/15
UL & CAS approved	Yes
Power supply	1-phase
Grinding width, in (mm)	18 (450)
Grinding disc, in (mm)	7 (178)
Grinding disc segment capacity	9
Grinding pressure total, lbs (kgs)	152 (70)
Grinding disc speed, rpm	495/705
Direction of rotation	Counter Rotation
Dimensions, in (mm) (L x W x H)	55 x 20 x 41 (1,400 x 510 x 1,050)
Dust port size, in (mm)	2 (51)
Weight, lbs (kgs)	240 (109)
Recommended generator size, kW	10
Recommended dust extractor size, CFM	250+
Recommended dust extractor size, CFM	285

# Husqvarna PG 400 Petrol

## Applications

- Productive single-disc gas floor grinder for a wide range of outdoor applications.
- Efficiently grinds lippage on concrete slabs, trip hazards, removal of paint, epoxy and spackle on medium to large concrete areas.

## Benefits

- The extra operating present control handle ensures that the operator has his/her hands safely on the handle of the grinder when operating the machine.
- A durable steel bumper protects the front of the gearbox and engine.
- The machine has a user-friendly control panel with an easy-to-use throttle control.
- Self-adjusting floating cover with brush skirt follows the surface of the floor, enabling a tight seal to prevent dust from entering the working environment.
- The chassis/frame can be separated from the grinding head in less than 30 seconds, making it easy to transport.



## Surface Preparation Model

PG 400 Petrol

Part No. (Honda GXV 390)

967676301

## Technical Specifications

Power, hp (kW)	10.2 (7.6) @ 3,600 rpm
Power supply	Honda GXV 390, air-cooled 4-stroke OHV gas engine, vertical shaft, cast iron sleeve
Fuel tank volume, gal (L)	.55 (2.1)
Engine oil capacity, gal (L)	.3 (1.1)
Grinding width, in (mm)	16 (400)
Grinding disc, in (mm)	16 (400)
Grinding disc segment capacity	9
Grinding pressure total, lbs (kgs)	152 (69)
Grinding disc speed, rpm	440-1,125
Director of rotation	Clockwise
Dimensions, in (mm) (L x W x H)	35.4 x 19 x 28 (900 x 480 x 710)
Dust port size, in (mm)	2 (51)
Weight, lbs (kgs)	308 (140)
Recommended dust extractor size, CFM	350+

# Husqvarna PG 400

## Applications

- Capable of grinding adhesive residue, paint and epoxy on large concrete areas.
- Efficient removal of carpet glue, mastic, roofing tar, etc.

## Benefits

- Self-adjusting floating cover with brush skirt follows the surface of the floor and the tight seal prevents dust from entering the working environment.
- The chassis/frame can be separated from the grinding head in less than 30 seconds. The frame folds tightly and can be wheeled around. Having two separate pieces enables the grinder to fit into the trunk of most vehicles.
- The speed is fixed and no settings are required.
- Powerful 6.5 hp, 3-phase motor enables high production rates.
- Redi Lock® is an instant and hassle-free system for changing diamond tooling.
- Possibility to log operating hours.
- Adjustable handlebar makes the setting of an ergonomic position easy.



Surface Preparation Model	PG 400
Part No. (230-240 V - 18 A) (50' 10 gauge extension cord included)	967966406
Part No. (230-240 V - 15 A)	967966404
Part No. (380-480 V - 9 A)	967966405

## Technical Specifications

Power, hp (kw)	4/6.5 (3/4.8)
Voltage, V	220-240/380-480
Plug type	L6-30/L15-20/L16-20
Rated current, A	18/15/9
UL & CAS approved	Yes/Yes/No
Power supply	1-phase or 3-phase
Grinding width, in (mm)	16 (400)
Grinding disc, in (mm)	16 (400)
Grinding disc segment capacity	18
Grinding pressure total, lbs (kgs)	143 (64)
Grinding disc speed, rpm	1,720
Direction of rotation	Clockwise
Dimensions, in (mm) (L x W x H)	55 x 20 x 41 (1,400 x 510 x 1,050)
Dust port size, in (mm)	2 (51)
Weight, lbs (kgs)	254 (115)
Recommended generator size	12
Recommended dust extractor size, CFM	350+
Recommended dust extractor size, CFM	285



# Husqvarna PG 280

## Applications

- Perfect for grinding adhesive residue, paint and epoxy on medium-sized concrete areas.
- Efficiently grinds due to high rpm levels and a wide range of discs available for various applications.
- Convenient conversion to edge grinding.

## Benefits

- Controlled edge grinding with the edge function and wall protector.
- Self-adjusting floating cover with brush skirt follows the surface of the floor and the tight seal prevents dust from entering the working environment.
- The chassis/frame can be separated from the grinding head in less than 30 seconds. The frame folds tightly and can be wheeled around. Having two separate pieces enables the grinder to fit into the trunk of most vehicles.
- Easily removable lid covers and wheel setting enable quick conversion to edge grinding on both sides. No tools are required. Allows an upright work position.
- The speed is fixed and no settings are required.



Surface Preparation Model	PG 280
Part No. (110-120 V - 15 A) (50' 10 gauge extension cord included)	970494606
Part No. (220-240 V - 13 A) (50' 10 gauge extension cord included)	970494604

## Technical Specifications

Power, hp (kW)	2/3 (1.5/2.2)
Voltage, V	110-120/220-240
Plug Type	L5-15/L6-20
Rated current, amps	15/13
UL & CSA approved	Yes
Power supply	1-phase
Grinding width, in (mm)	11 (280)
Grinding disc, in (mm)	11 (280)
Grinding disc segment capacity	12
Grinding pressure total, lbs (kgs)	77 (35)
Grinding disc speed, rpm	970/1,720
Direction of rotation	Clockwise
Dimensions (L x W x H), in (mm)	47 x 16 x 39 (1,200 x 410 x 1,000)
Dust port size, in (mm)	2 (51)
Weight, lbs (kgs)	154 (70)
Recommended generator size, kW	6.5-20A/7.5-20A Circuit
Recommended dust extractor size, CFM	250+
Recommended dust extractor size, CFM	285

# Husqvarna CG 200

## Applications

- Designed for texturing or grooving concrete or asphalt floors.
- It can also be used for concrete coating removal, floor prep, traffic line removal, and paint or glue removal on floors.

## Benefits

- Equipped with vibration-damping handles for operator comfort.
- Millimeter adjustment for precise depth of operation setting.
- Central exhaust for dust extraction, which results in a cleaner working environment.
- Automatic reset to the selected cutting depth and quick release of the drum from the ground.
- Equipped with tie down slot as standard.
- Possibility to log operating hours.



## Surface Preparation Model

CG 200

Part No. (1 x 200 V - 30 A) (does not include drum or tooling)

967662302

## Technical Specifications

Power, hp (kW)	9 (6.7)
Power supply	Gas
Grinding width, in (mm)	7.8 (200)
Cutting depth, max, in (mm)	.511 (13)
Recommended cutting depth, in (mm)	0-15 (0-4)
Vacuum port connection, in (mm)	2 (50)
Belt	Single, poly-V
Drum rotation speed (max off load), rpm	1,350
Dimensions, in (mm) (L x W x H)	33 x 21 x 9 (840 x 530 x 730)
Dust port size, in (mm)	2 (51)
Weight (excluding tool drum), lbs (kgs)	141 (64)

# Surface Prep Accessories & Spare Parts

Accessories & Spare Parts	PG 830	PG 820	PG 690	PG 690 P	PG 680	PG 540	PG 530	PG 510
Brush skirt, non marking	585138405	X	X	X	X	X		
Skirt, bushhammer	585246301			X	X	X		
Skirt, bushhammer	585564101					X	X	
Box, surface prep tooling & accessories	501685101	X	X	X	X	X	X	X
Carbide holder, redi lock	581276802	X	X	X	X	X	X	X
Carbide holder replacement screw	585659501	X	X	X	X	X	X	X
Carbide, 1" x 1" replacement	581285001	X	X	X	X	X	X	
Flex head PG 830/PG 690, medium	589660901	X	X	X	X			
Flex head PG 830 & PG 690 soft	502533802	X	X	X	X			
Flex head PG 680, soft	502533803				X			
Flex head PG 530, soft	502533804						X	
Grinding head, conventional	502558201					X	X	
Grinding head, standard	502534001	X	X	X	X			
Head lock	587451401	X	X	X	X	X	X	
Head lock screw	725537051	X	X	X	X	X	X	
Redi Lock® diamond holder plate	502532201	X	X					
Redi Lock® diamond holder plate	502545801			X	X	X	X	
Resin holder plate	596901301	X	X	X	X			
Resin holder plate	596901302				X	X	X	X
Resin holder plate, replacement rubber pad	596901304	X	X	X	X			
Resin holder plate, replacement rubber pad	596901305				X	X	X	X
Resin holder plate, replacement velcro	596901307	X	X	X	X			
Resin holder plate, replacement velcro	596901308				X	X	X	X
Rubber skirt, non marking	590499203	X	X					
Rubber skirt, non marking	590499202			X	X	X		
Rubber skirt, non marking	590499201					X	X	
Silicone ring	502534301	X	X	X	X	X		
Silicone ring	502533901					X	X	
Steel spring, flex medium PG 830/820/690	502534102	X	X	X	X			
Steel spring, flex soft PG 830/820/690	502534103	X	X	X	X			
Steel spring, flex soft PG 680	581636802					X		
Steel spring, flex medium PG 680	581636801					X		
Steel spring, standard head replacement	502534201	X	X	X	X			
Steel spring, standard head	502548201					X		
Water kit	505453201	X	X	X	X	X	X	X

Accessories & Spare Parts	PG 450	PG 400 P	PG 400	PG 280	CG 200
Adapter, pigtail (115V, 30amp model)	581488201			X	
Brush skirt, non marking	585138405	X			
Brush, back shroud	585138402			X	
Brush, front shroud	585138406			X	
Brush, side shroud (left or right)	585138403			X	
Box, surface prep tooling & accessories	501685101	X		X	
Carbide holder, redi lock	581276802	X		X	
Carbide holder replacement screw	585659501	X		X	
Carbide, 1" x 1" replacement	581285001			X	
Head lock	587451401	X			
Head lock screw	725537051	X			
Puck, adapter Redi Lock® resin pad	587652701		X	X	
Redi Lock® diamond holder plate	584850201	X			
Redi Lock® diamond holder, PG 400	587795801		X		
Redi Lock® diamond holder, PG 280	522677301			X	
Resin holder plate	596901303	X			
Resin holder plate, replacement velcro	596901309	X			
Resin pad holder, 11"	595023401			X	
Riser, 3" Redi lock® resin pad	542870097		X	X	
Rubber damper	510213101		X	X	
Bearing complete, left	543045051				X
Bearing complete, right	543041871				X
Belt	543044980				X
Wheel, front	543045936				X
Wrench	543045893				X

# Surface Prep Floor Treatment Products

## GM 3000™ Floor Grouting System

GM 3000™ is specifically formulated for re-grouting and hole filling in concrete surfaces. It's an inherent part of the HiPERFLOOR process. GM 3000™ is effective for patching and filling small air pockets / pin holes when polishing concrete floors.



GM 3000	
Product	Part Number
GM 3000 (55 gal/208 L)	543087164
GM 3000 (5 gal/20 L)	543087161
GM 3000 (1 gal/5 L)	581921801

## Hiperhard™ Floor Hard System

Hiperhard™ is an additional treatment product in the HiPERFLOOR process. It is a potassium densifier applied to the concrete surface, to react with the calcium hydroxide that already exists in the concrete. A crystalline /glassy structure is formed in the pores of the concrete near the surface, and this is a main contributor to increasing the surface hardness of the concrete.



Hiperhard	
Product	Part Number
Hiperhard (55 gal/208 L)	580990201
Hiperhard (5 gal/20 L)	543087165
Hiperhard (1 gal/5 L)	581921802

## Hiperlith™ Floor Hard System

Hiperlith™ is an additional treatment product in the HiPERFLOOR process. It is a lithium-based densifier applied to the concrete surface, to react with the calcium hydroxide that already exists in the concrete. A crystalline /glassy structure is formed in the pores of the concrete near the surface, and this is a main contributor to increasing the surface hardness of the concrete.



Hiperlith	
Product	Part Number
Hiperlith (55 gal/208 L)	578273602
Hiperlith (5 gal/20 L)	578273601
Hiperlith (1 gal/5 L)	581995701

## Surface Prep Floor Treatment Products

### Hiperguard™ WB/SB

#### Floor Protection & Color Enhancement System

Hiperguard™ is a premium-grade surface impregnator, which is used in the final step of the HiPERFLOOR process. Hiperguard™ penetrates the concrete to form a film along the surface of the capillaries. This increases the surface tension of the floor, restricting the absorption of water, oil, fats and dirt.



Hiperguard WB/SB		
Product	WB Part Number	SB Part Number
Hiperguard (55 gal/208 L)	580990202	593906510
Hiperguard (5 gal/20 L)	579273604	593906509
Hiperguard (1 gal/5 L)	579273603	593906508

### Hiperseal™

#### Floor Protection System

Hiperseal™ is a topical sealer that can be applied to a concrete surface at the end of the polishing process. Hiperseal™ improves the surface sheen and stain resistance of the concrete. It makes the concrete significantly more resistant to fats, oils, water, foods, and mild acids (ex: orange juice). It works by sealing the concrete surface, and not allowing penetration of foreign material into the concrete.



Hiperseal	
Product	Part Number
Hiperseal (55 gal/208 L)	586916403
Hiperseal (5 gal/20 L)	586916402
Hiperseal (1 gal/5 L)	586916401

### Hiperclean™ Cleanser

#### Floor Cleansing System

Hiperclean™ Cleanser is a safe and economical no-rinse daily cleaner that is designed to be used on a HiPERFLOOR or other polished concrete surfaces. It is pH neutral and will not create a residue build-up. The cleanser may be used on an auto-scrubber with a white, natural hair, or 3,000 grit diamond impregnated Husqvarna cleaning pad or with a microfiber mop. Hiperclean Cleanser is an integral part of keeping a HiPERFLOOR system.



Hiperclean Cleanser	
Product	Part Number
Hiperclean (55 gal/208 L)	587344003
Hiperclean (5 gal/20 L)	587344002
Hiperclean (1 gal/5 L)	587344001



# HIPER 3 Floor Polishing System



SURFACE PREPARATION

## Overview:

Resulting floors will be smooth, shiny and aesthetically pleasing as well as easy to maintain. The final, flat surface, makes it easy to keep your floors clean and it meets current traction/slip requirements (ANSI 137.1). **Enhancing the beauty of your concrete floors is as simple as Hiper 3.**

## Basic Steps:

- 1) Grind with step 1 pads
- 2) Apply (Chemical A) liquid hardener
- 3) Polish with step 2 pads
- 4) Fine polish with step 3 pads
- 5) Apply (Chemical B) liquid sealer
- 6) Fine polish again with step 3 pads

## Equipment:

- 1) PG 450 grinder
- 2) S 26 vacuum
- 3) Chemical A & B
- 4) Step 1 pad
- 5) Step 2 pad
- 6) Step 3 pad



**HIPER 3 KIT**

## Hiper 3 Kit

Product	Part Number
Hiper 3 Bucket	<b>590587401</b>
Chemical A	
Chemical B	
Step 1 (grinding pad)	
Step 2 (polishing pad)	
Step 3 (fine polishing pad)	

[\*\*CLICK HERE TO SEE IT IN ACTION!\*\*](#)

# How to Control Dust while Grinding



## T Line Vacuums

Product	Efficiency	HEPA Filter	PG 400 Petrol	PG 690	PG 830
T 18000 3-phase	99.99% @ .3 Microns	4 HEPA CLASS H 13		X	X
T 10000 3-phase	99.99% @ .3 Microns	3 HEPA CLASS H 13		X	X
T 8600 3-phase	99.99% @ .3 Microns	2 HEPA CLASS H 13		X	X
T 7500 3-phase	99.99% @ .3 Microns	2 HEPA CLASS H 13		X	X
T 4000 Petrol	99.99% @ .3 Microns	2 HEPA CLASS H 13	X		
T 8600 Propane	99.99% @ .3 Microns	2 HEPA CLASS H 13		X	X

## S Line Vacuums

Product	Efficiency	HEPA Filter	PG 280	PG 400	PG 400 Petrol	PG 450	PG 510	PG 540
S 36 1-phase	99.99% @ .3 Microns	3 HEPA CLASS H 13		X	X	X	X	X
S 26 1-phase	99.99% @ .3 Microns	2 HEPA CLASS H 13	X			X		

## DC Line Vacuum

Product	Efficiency	HEPA Filter	PG 690	PG 830
DC 6000	99.99% @ .3 Microns	HEPA 13	X	X

## C Line Pre-Separators

Product	Efficiency	S 13	S 26	S 36	DC 6000	T 4000	T 7500	T 8600	T 10000	T 18000
C 5500	Separated 80-90% material before dust extractor				X		X	X	X	X
C 3000	Separated 80-90% material before dust extractor	X	X	X		X				

## A Line Air Filters

Product	Efficiency	HEPA Filter	General Information
A 2000 w/Pre-filter	99.99% @ .3 Microns	1 HEPA CLASS H 13	600 cfm X 60 = 36,000 cf/hour or 5 air changes per hour on 900 sq ft space 8' height (7,200 cu ft)
A 600 w/Pre-filter	99.99% @ .3 Microns	1 HEPA CLASS H 13	1200 cfm X 60 = 72,000 cf/hour or 5 air changes per hour on 1,800 sq ft space 8' height (14,400 cu ft)

# Surface Prep Diamond Tooling



SURFACE PREPARATION

MATERIAL	G1400 SERIES					G600 SERIES				SHARX	G200
	G1410	G1420	G1440	G1470	G1480	G620	G640	G670	ARROW		
REMOVAL	-	-	-	-	-	-	-	-	-	-	-
POROUS CERAMIC GLUES	-	-	●	●●●	●●	●	-	●●●	-	-	-
PLASTIC-LIKE CERAMIC GLUES	-	●	●●●	-	-	●	●●●	-	●●●	-	●●●
VINYL GLUES	●	●●	●●●	●	●	●●	●●●	●	●●●	-	●●●
PAINT & THIN EPOXY (<2 MM)	●	●●	●●●	●	●	●●	●●●	●	●●●	-	●●●
THICK EPOXY (15-40 MM)	-	●	●●●	●	-	●	●●●	●	-	-	●●●
GRINDING	-	-	-	-	-	-	-	-	-	-	-
RAIN-DAMAGED CONCRETE	-	-	-	●●	●●●	-	●	●●	-	-	●
CONCRETE, SOFT	-	-	-	●●●	●●	-	●●	●●●	-	-	●●
CONCRETE, MEDIUM HARD	-	●	●●●	●	-	●	●●●	●	-	-	●●●
CONCRETE, HARD	●●●	●●●	●	-	-	●●●	●	-	-	●	●
SEMI-POLISHED CONCRETE	●●●	●	-	-	-	●	-	-	-	-	-

●●●= Optimal ●●= Good ●= Acceptable - = Not recommended

GOLD	SILVER	BRONZE
------	--------	--------



# Surface Prep Diamond Tooling Information

## Coding

Husqvarna's range of diamond grinding and polishing tools is the result of our commitment to providing the best possible options for every situation and application. The diamond tools are coded to be able to easily find the correct level of performance, applications, bond size, grit size and segment size for any project.



## Product Codification Guide

### A - Application

G for grinding applications

P for polishin applications

### B - Level of Performance

G1400 series represents the highest level of performance for all professionals focusing on high efficiency and profitability.

G600 series is a good, low cost alternative where production outweighs tool life.

P1200 Dry

P100 Wet

### C - Bond Type/Related Application

G1410 - very soft tool to grind the hardest floors

G1420 - soft tool for hard surface grinding

G1440 - medium tool for medium-hard concrete

G1470 - hard tool for soft and abrasive concrete

G1480 - very hard tool for very abrasive surface

G620 - soft tool for hard surface grinding

G640 - medium tool for soft and abrasive concrete

G670 - hard tool for soft and abrasive concrete

P1240 - highest performance in concrete and terazzo polishing

P1280 - very hard tool for wet applications and stain removal

### D - Grit Size Reference/Related Mesh Size

3 - 20/30

4 - 30/40

5 - 60/80

6 - 120/140

### E - Reference/Segment

S - Single

D - Double

T - Triple

### F - Grit Size Reference/Related Mesh Size

2 - 50

3 - 100

4 - 200

5 - 400

6 - 800

7 - 1500

8 - 3,000

## Wet vs Dry Grinding

The Husqvarna range of metal bond tools covers tooling for both wet and dry grinding.

### Wet

- Production rates will be higher than dry grinding.
- Diamond segments can wear faster due to presence of abrasive slurry.
- Scratches from diamond grit may be deeper.
- Increased clean up time.

### Dry or Slightly Wet

- Production rates will be slower on harder materials than when wet grinding.
- Softer bond segments are required in order to encourage segment wear.
- Scratches from diamond grit may not be as deep when compared to wet grinding.
- More heat is generated by the diamond segment.
- Cleaner work environment.

## Power & Weight

A more powerful machine enables the operator to choose harder bond tools.

## Grit Size

Changing the size of the diamond grit to a smaller particle/grit size will affect the performance of the diamond tool in the following ways:

- Create a finer scratch pattern.
- Increase the life of the diamond tool.
- The opposite will occur when changing to a larger particle/grit size.

Grit Size (Mesh)	Application
20	Material Removal
30	Rough Grinding
50	Medium Grinding
100	Fine Grinding



## Metal-Bond Diamond Tools - Redi Lock®

Redi Lock diamond tools are perfect for concrete grinding applications, such as aggregate exposure, preparation for tiling floors, removal of epoxy coatings and sealers as well as flattening. The system eliminates the need for multiple sets of diamond disc holders, and replaces time consuming screw-on-diamond systems. The Redi Lock dovetail simply locks into the slot and is ready for use. The system is available for a variety of machine manufacturers.

Husqvarna offers two series of Redi Lock tools, the G 1400 and G 600. With five different types of products, the G1400 series offers the excellent removal rates and durability, providing maximum profitability and performance with all types of applications. It also covers surface preparation applications in only three steps before using the resin tools in polishing applications. The G600 series is cost competitive tooling with good performance when used on grinders smaller than the PG 830.

### Half Set vs Full Set

**Half Set** – Diamonds are placed at three alternating positions (or four on the PG 400) on the diamond holder disc. When using a half set, the diamonds tend to follow the surface of the floor. This puts more weight per square inch on the diamond tooling, making it grind more aggressively on hard floors. It does not completely flatten the floor.

**Full Set** – Diamonds are placed at each of the six positions (or eight on the PG 400) on the diamond holder disc. The full set is used when a flat floor is desired. If the floor has undulations, the machine will grind the high areas to match the low spots. The result is a smooth surface.

### Single Segment vs Double Segment

**Single Segment** – Working with a single segment will increase the pressure on each segment. This will lead to more aggressive and increased productivity; however, the life of the tool will be shorter.

**Double Segment** – Working with a double segment will decrease the pressure on each segment, reducing the wear rate on the diamond segments. This will lead to a smoother scratch pattern, and will also reduce the load on the machine.

# Tools for Coating & Concrete Cap Removal

## G1410 Grinding Segments

13 MM SEGMENT HEIGHT, SOLD IN 3 PACKS

- Optimal performance: hard concrete or semi-polished concrete.
- Acceptable performance: vinyl glues, paint and thin epoxy, or thick epoxy.



### G1410 | X-Soft

Name	Shape	Single/Double	Grit Size (Mesh)	Part Number
G1413S	Two Notch	Single	20	501897901
G1413D	Two Notch	Double	20	501897902
G1414S	One Notch	Single	30	501898901
G1414D	One Notch	Double	30	501898902
G1415S	Rounded End	Single	50	501899201
G1415D	Rounded End	Double	50	501899202
G1416S	Round	Single	100	501899701
G1416D	Round	Double	100	501899702

## G1420 Grinding Segments

13 MM SEGMENT HEIGHT, SOLD IN 3 PACKS

- Optimal performance: hard concrete.
- Good performance: vinyl glues, paint and thin epoxy.
- Acceptable performance: concrete medium, semi-polished concrete, plastic-like ceramic glues, thick epoxy.



### G1420 | Soft

Name	Shape	Single/Double	Grit Size (Mesh)	Part Number
G1423S	Two Notch	Single	20	501899901
G1423D	Two Notch	Double	20	501899902
G1424S	One Notch	Single	30	501900701
G1424D	One Notch	Double	30	501900702
G1425S	Rounded End	Single	50	501900801
G1425D	Rounded End	Double	50	501900802
G1426S	Round	Single	100	501901501
G1426D	Round	Double	100	501901502



## Tools for Coating & Concrete Cap Removal

### G1440 Grinding Segments

13 MM SEGMENT HEIGHT, SOLD IN 3 PACKS

- Optimal performance: plastic-like ceramic glues, vinyl glues, paint and thin epoxy. Thick epoxy.
- Good performance: medium concrete.
- Acceptable performance: hard concrete.



#### G1440 | Medium

Name	Shape	Single/Double	Grit Size (Mesh)	Part Number
G1443S	Two Notch	Single	20	501902501
G1443D	Two Notch	Double	20	501902502
G1444S	One Notch	Single	30	501904901
G1444D	One Notch	Double	30	501904902
G1445S	Rounded End	Single	50	501906501
G1445D	Rounded End	Double	50	501906502
G1446S	Round	Single	100	501907401
G1446D	Round	Double	100	501907402

### G1470 Grinding Segments

13 MM SEGMENT HEIGHT, SOLD IN 3 PACKS

- Optimal performance: soft concrete, porous ceramic glues.
- Good performance: rain-damaged concrete.
- Acceptable performance: medium concrete, vinyl glues, paint and thin epoxy. Thick epoxy.



#### G1470 | Hard

Name	Shape	Single/Double	Grit Size (Mesh)	Part Number
G1473S	Two Notch	Single	20	501907701
G1473D	Two Notch	Double	20	501907702
G1474S	One Notch	Single	30	501907901
G1474D	One Notch	Double	30	501907902
G1475S	Rounded End	Single	50	501908101
G1475D	Rounded End	Double	50	501908102

### G1480 Grinding Segments

13 MM SEGMENT HEIGHT, SOLD IN 3 PACKS

- Optimal performance: rain-damaged concrete.
- Good performance: soft concrete, porous ceramic glues.
- Acceptable performance: vinyl glues, paint and thin epoxy.



#### G1480 | X-Hard

Name	Shape	Double/Triple	Grit Size (Mesh)	Part Number
G1483D	Two Notch	Double	20	501908201
G1483T	Two Notch	Triple	20	501908202
G1484D	One Notch	Double	30	501908301
G1484T	One Notch	Triple	30	501908302

# Tools for Coating & Concrete Cap Removal

## G620 Grinding Segments

10.5 MM SEGMENT HEIGHT, SOLD IN 3 PACKS



- Optimal performance: hard concrete.
- Good performance: vinyl glues, paint and thin epoxy.
- Acceptable performance: medium concrete, semi-polished concrete, plastic-like ceramic glues. Thick epoxy.

### G620 | Soft

Name	Shape	Single/Double	Grit Size (Mesh)	Part Number
G623S	Hexagonal	Single	20	503847902
G623D	Hexagonal	Double	20	503847903
G624S	Hexagonal	Single	30	503847904
G624D	Hexagonal	Double	30	503847905
G625S	Round	Single	50	503847906
G625D	Round	Double	50	503847907
G627S	Round	Single	100	503847908
G627D	Round	Double	100	503847909

## G640 Grinding Segments

10.5 MM SEGMENT HEIGHT, SOLD IN 3 PACKS



- Optimal performance: medium concrete, plastic-like ceramic glues, vinyl glues, paint and thin epoxy. Thick epoxy.
- Good performance: soft concrete
- Acceptable performance: hard concrete, rain-damaged concrete

### G640 | Medium

Name	Shape	Single/Double	Grit Size (Mesh)	Part Number
G643S	Hexagonal	Single	20	503883401
G643D	Hexagonal	Double	20	503883402
G644S	Hexagonal	Single	30	503883403
G644D	Hexagonal	Double	30	503883404
G645S	Round	Single	50	503883405
G645D	Round	Double	50	503883406
G647D	Round	Double	100	503883408

## G670 Grinding Segments

10.5 MM SEGMENT HEIGHT, SOLD IN 3 PACKS

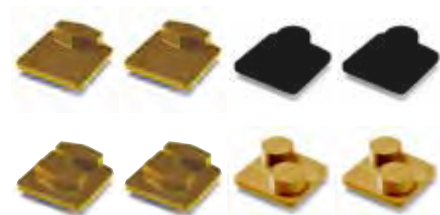

- Optimal performance: soft concrete, porous ceramic glues, plastic-like ceramic glues.
- Acceptable: medium concrete, rain-damaged concrete, vinyl glues, paint and thin epoxy. Thick epoxy.

### G670 | Hard

Name	Shape	Single/Double	Grit Size (Mesh)	Part Number
G673S	Hexagonal	Single	20	503885501
G673D	Hexagonal	Double	20	503885502
G674S	Hexagonal	Single	30	503885503
G674D	Hexagonal	Double	30	503885504
G675D	Round	Double	50/60	503885505
G677D	Round	Double	100	503885506

## Tools for Coating & Concrete Cap Removal

### G200 Rental Segments

3 MM SEGMENT HEIGHT, SOLD IN 3 PACKS

- Small floor grinding jobs.
- Optimal performance: medium concrete.
- Good performance: soft concrete.
- Acceptable performance: hard concrete.

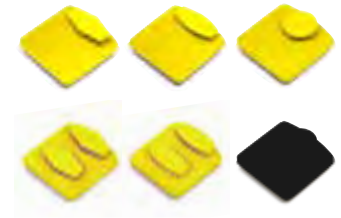

#### G200

Name	Shape	Single/Double	Grit Size (Mesh)	Part Number
G225S	Hexagon	Single	30	588099901
G225D	Hexagon	Double	30	588099904
G227S	Convex	Single	60	588099902
G227D	Convex	Double	60	588099905
G243S	Round	Single	120	588099903

### Redi Lock 10 Segment

INITIAL GRINDING STEPS

- Excellent life when used either wet or dry on soft-medium concrete.
- Removal rate can be easily controlled.
- Optimal performance: medium concrete.
- Good performance: soft concrete.



#### Redi Lock 10 Segment

Name	Bond	Grit Size (Mesh)	Part Number
10 Segment Diamond S20	Soft	20	580251509
10 Segment Diamond S60	Soft	60	580251510
10 Segment Diamond S120	Soft	120	580251511
10 Segment Diamond S20	Medium	20	580251512
10 Segment Diamond S60	Medium	60	580251513
10 Segment Diamond S120	Medium	120	586000401

### Piranha™ PCD

AGGRESSIVE REMOVAL OF CONCRETE, ADHESIVE & SCREEDS

- PCD: single or double quarter-round PCD with protective diamond strip. For maximum wear & productivity.

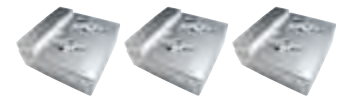

#### Piranha™ PCD

Name	Single/Double	Recommended Equipment	Part Number
G11X1D - 3 pack	Double	All grinders	543327302
G11Y1D - 3 pack	Double	PG 830 & PG 690	543327303
G14XX - 3 pack	Single	All grinders	543327301

# Tools for Coating & Concrete Cap Removal

## Arrow G600 Series

### REMOVAL OF EPOXY & GLUE



- Arrow G600: Redi lock design. Works on all Husqvarna grinders. (all doubles)

Arrow G600			
Name/Color	Bond Hardness	Grit Size (Mesh)	Part Number
G621D - Green	Soft	20	585672404
G641D - Grey	Medium	20	585672408
G671D - Cooper	Hard	20	585672406

## RT Cap Cutters

### AGGRESSIVE REMOVAL OF HARD TROWELED CAP ON CONCRETE

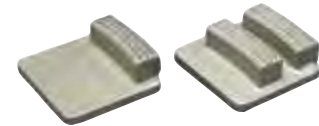

- RT Cap: ripple top segment with alternating hard-soft bond

RT Cap Cutters		
Name	Single/Double	Part Number
RT Cap Cutter S	Single	587822509
RT Cap Cutter D	Double	587522508

## Husqvarna Sharx™

### FAST & EASY REMOVAL OF DENSE SURFACES ON HARD TROWELED CONCRETE



- Sharx: metal bond significantly increases the productivity & ensures pads stay open and sharpe.

Sharx™				
Name	Shape	Bond Hardness	Grit Size (Mesh)	Part Number
Sharx Single	Arrow	Ultra Soft	30	574430402
Sharx Double	Arrow	Ultra Soft	30	574430403

## Bushhammers

### BRUSHHAMMERED SURFACE



- Bushhammer: creating a course floor to prepare for floor covering.  
Bushhammered or large aggregate exposed surface.

Bushhammers	
Description	Part Number
<b>Full Kits (plates + mounting brackets + rollers)</b>	
*Husqvarna BHT 9 in (230 mm) - (PG 690, PG 540, PG 510)	593344201
*Husqvarna BHT 10.6 in (270 mm) - 3 rollers (PG 830)	593344211
*Husqvarna BHT 10.6 in (270 mm) - 6 rollers (PG 830)	593344212
<b>Replacement Parts</b>	
Fix Kit (roller mounting bracket)	595018102
Husqvarna BH Rollers (roller only)	597650304
Husqvarna BHT Plate 9 in (230 mm) - (PG 690, PG 540, PG 510)	597650301
Husqvarna BHT Plate 10.6 in (270 mm) - 3 roller (PG 830)	597650302
Husqvarna BHT Plate 10.6 in (270 mm) - 6 roller (PG 830)	597650303
PG 690 Bush Hammer Skirt	594080205
PG 830 Bush Hammer Skirt	594080206

# Polishing Pads for Concrete Floors

## T60 Transitional Pads

### HONING OF CONCRETE



- T60: use between metal & resin polishing pads. Velcro-backed, must use slightly wet.

#### T60 Series

Name/Color	Dimensions, in (mm)	Grit Size (Mesh)	Recommended Equipment	Part Number
T62 - Green	2.5 (63.5)	50	PG 450	587682601
T63 - Red	2.5 (63.5)	100	PG 450	587682602
T64 - Yellow	2.5 (63.5)	200	PG 450	587682603
T62 - Green	3 (76.2)	50	PG 830, PG 690, PG 540, PG 510	542868130
T63 - Red	3 (76.2)	100	PG 830, PG 690, PG 540, PG 510	542868131
T64 - Yellow	3 (76.2)	200	PG 830, PG 690, PG 540, PG 510	542868132
T65 - Blue	3 (76.2)	400	PG 830, PG 690, PG 540, PG 510	542868133

## Overlay Pads

### HONING OF CONCRETE OVERLAY



- Overlay: for use on concrete overlay floors. Velcro-backing.

#### Overlay Pads

Name	Dimensions, in (mm)	Grit Size (Mesh)	Recommended Equipment	Part Number
Overlay Pads	3 (76.2)	50	PG 830, PG 690, PG 540, PG 510, PG 450	542870057
Overlay Pads	3 (76.2)	100	PG 830, PG 690, PG 540, PG 510, PG 450	542870058
Overlay Pads	3 (76.2)	200	PG 830, PG 690, PG 540, PG 510, PG 450	589684516

## P1240 Resin Polishing Pads

### DRY CONCRETE POLISHING



- P1240: allows user to reach a certain gloss level in fewer steps, which saves time & tooling cost. Dry polishing of concrete on PG machines. Highly recommended to be used in conjunction with Hiperhard floor densifier/hardener.

#### P1240

Name/Color	Dimensions, in (mm)	Grit Size (Mesh)	Part Number
P1242 - Green	3 (76.2)	50	574428201
P1243 - Black	3 (76.2)	100	574428301
P1244 - Red	3 (76.2)	200	574428401
P1245 - Yellow	3 (76.2)	400	574428501
P1246 - White	3 (76.2)	800	574428601
P1247 - Blue	3 (76.2)	1,500	574428701
P1248 - Grey	3 (76.2)	3,000	574428801



# Polishing Pads for Concrete Floors

## FP40 HiperFlex Pads

### DRY CONCRETE POLISHING



- FP40: for polishing concrete of overpayments. Polishes & cleans at the same time. Superior, durable shine.

#### T60 Series

Name	Dots/Pads	Dimensions, in (mm)	Grit Size (Mesh)	Recommended Equipment	Part Number
FP44	3	7 (178)	200	PG 450	<b>587546701</b>
FP45	3	7 (178)	400	PG 450	<b>587546702</b>
FP46	3	7 (178)	800	PG 450	<b>587546703</b>
FP47	3	7 (178)	1500	PG 450	<b>587546704</b>
FP48	3	7 (178)	3000	PG 450	<b>587546705</b>
FP43	4	9 (229)	100	PG 690, PG 540, PG 510	<b>587546712</b>
FP44	4	9 (229)	200	PG 690, PG 540, PG 510	<b>542779316</b>
FP45	4	9 (229)	400	PG 690, PG 540, PG 510	<b>542779317</b>
FP46	4	9 (229)	800	PG 690, PG 540, PG 510	<b>542779318</b>
FP47	4	9 (229)	1500	PG 690, PG 540, PG 510	<b>542779319</b>
FP48	4	9 (229)	3000	PG 690, PG 540, PG 510	<b>542779320</b>
FP43	5	11 (280)	100	PG 830	<b>587546711</b>
FP44	5	11 (280)	200	PG 830	<b>542870056</b>
FP45	5	11 (280)	400	PG 830	<b>542868407</b>
FP46	5	11 (280)	800	PG 830	<b>542868408</b>
FP47	5	11 (280)	1500	PG 830	<b>542868409</b>
FP48	5	11 (280)	3000	PG 830	<b>542868410</b>

## Edging Tools for Concrete Floors

### P1240 Handheld Polishing Pads

USED ON HANDHELD GRINDERS



- P1240 Handheld: allows user to reach a certain gloss level in fewer steps, which saves time & tooling cost.
- The pads are available in 5" full or 7" ring (velcro-backed).

#### P1240 Handheld

Name/Color	Dimensions, in (mm)	Grit Size (Mesh)	Part Number
P1242 - Green	5 (127)	50	574428901
P1243 - Black	5 (127)	100	574429001
P1244 - Red	5 (127)	200	574429101
P1245 - Yellow	5 (127)	400	574429201
P1246 - White	5 (127)	800	574429301
P1247 - Blue	5 (127)	1,500	574429601
P1248 - Gray	5 (127)	3,000	574429701
P1242 - Green	7 Ring (178)	50	593124701
P1243 - Black	7 Ring (178)	100	593124801
P1244 - Red	7 Ring (178)	200	593124901
P1245 - Yellow	7 Ring (178)	400	593125001
P1246 - White	7 Ring (178)	800	593125101
P1247 - Blue	7 Ring (178)	1,500	593125201
P1248 - Gray	7 Ring (178)	3,000	593125301



P1242 (5")



P1243 (5")



P1244 (5")



P1245 (5")



P1240 (7" Ring)

### Corner Tools

USED ON HANDHELD OSCILLATING TOOLS

- Corner Tools: finishing touch in corners or walled spaces.



#### Corner Tools

Name/Color	Grit Size (Mesh)	Part Number
CT EL-50 - Blue	50	590533901
CT EL-100 - Yellow	100	590533902
CT EL-200 - Orange	200	590533903
CT EL-400 - Red	400	590533904
CT EL-800 - Green	800	590533905
CT EL-1,500 - Teal	1,500	590533906
CT EL-3,000 - Brown	3,000	590533907

# Edging Tools for Concrete Floors

## HD Edging Pads

USED ON HANDHELD GRINDING



- HD Edging Pads: aggressive edge pad perfect for hand grinding next to walls and on stairs.
- Makes quick work of removing scratches & blending edges into main floor polish.

### HD Edging Pads

Name/Color	Dimensions, in (mm)	Grit Size (Mesh)	Part Number
HD Edging Pads - Green	5 (127)	50	587581505
HD Edging Pads - Black	5 (127)	100	587581506
HD Edging Pads - Red	5 (127)	200	587581507
HD Edging Pads - Yellow	5 (127)	400	587581508
HD Edging Pads - Green	7 Ring (178)	50	587581509
HD Edging Pads - Black	7 Ring (178)	100	587581510
HD Edging Pads - Red	7 Ring (178)	200	587581511
HD Edging Pads - Yellow	7 Ring (178)	400	587581512

### Accessories for Handheld Machines

Product Description	Part Number
5" Adapter (125 mm) Velcro backing adapter, 5/8" - 11	542761323
7" Adapter (178 mm) Velcro backing adapter, 5/8" - 11	589686412



HD Edging Pads - Black



HD Edging Pads - Red



HD Edging Pads - Yellow



HD Edging Pads - Yellow



Adapters

SURFACE PREPARATION

# Maintenance Pads for Concrete Floors

## HiperClean Series Pads CLEANING OF POLISHED CONCRETE FLOORS



- HiperClean Pads: restores shine back to polished floor.
- HiperClean Burnishing Pads: use with burhishing equipment. Restores shine back to polished floor.
- Both pads can be used wet or dry.

### HiperClean Pads

Name	Grit Size (Mesh)	Recommended Equipment	Part Number
HiperClean 5"	400	Handheld Grinder	542870076
HiperClean 5"	800	Handheld Grinder	542870077
HiperClean 5"	1,500	Handheld Grinder	542870078
HiperClean 5"	3,000	Handheld Grinder	542870079
HiperClean 7"	400	PG 450	501764007
HiperClean 7"	800	PG 450	501764001
HiperClean 7"	1,500	PG 450	501764002
HiperClean 7"	3,000	PG 450	501764003
HiperClean 9"	400	PG 690, PG 540, PG 510	589810501
HiperClean 9"	800	PG 690, PG 540, PG 510	589810502
HiperClean 9"	1,500	PG 690, PG 540, PG 510	589810503
HiperClean 9"	3,000	PG 690, PG 540, PG 510	589810504
HiperClean 11"	400	PG 830	501764009
HiperClean 11"	800	PG 830	501764010
HiperClean 11"	1,500	PG 830	501764011
HiperClean 11"	3,000	PG 830	501764012

### HiperClean Burnishing Pads

Name	Grit Size (Mesh)	Recommended Equipment	Part Number
HiperClean 17"	400	Burnishing	542870080
HiperClean 17"	800	Burnishing	542870081
HiperClean 17"	1500	Burnishing	542870082
HiperClean 17"	3000	Burnishing	542870083
HiperClean 21"	400	Burnishing	542870084
HiperClean 21"	800	Burnishing	542870085
HiperClean 21"	1500	Burnishing	542870086
HiperClean 21"	3000	Burnishing	542870087
HiperClean 24"	400	Burnishing	542870088
HiperClean 24"	800	Burnishing	542870089
HiperClean 24"	1500	Burnishing	542870090
HiperClean 24"	3000	Burnishing	542870091
HiperClean 27"	400	Burnishing	542870092
HiperClean 27"	800	Burnishing	542870093
HiperClean 27"	1500	Burnishing	542870094
HiperClean 27"	3000	Burnishing	542870095

# Wet Tooling for Terrazzo, Marble & Concrete

## Lippage Metal Pads

### ROUGH GRINDING & HEAVY REMOVAL



- Lippage: use to rough grind epoxy or cement terrazzo and marble floors.
- Redi Lock® dovetail enables quick tooling changes.

Lippage Metal Pads				
Name	Dimensions, in (mm)	Grit Size (Mesh)	Recommended Equipment	Part Number
Lippage Metal Pads	3 (76.2)	40	All Husqvarna Grinders	<b>589781701</b>
Lippage Metal Pads	3 (76.2)	80	All Husqvarna Grinders	<b>589781702</b>
Lippage Metal Pads	3 (76.2)	150	All Husqvarna Grinders	<b>589781703</b>

## T80 Wet Transitional Pads

### HONING EPOXY OR CEMENT TERRAZZO, MARBLE & CONCRETE



- T80: use between metal and resin pad applications. Traditional style puck.

T80 Wet Transitional Pads				
Name/Color	Dimensions, in (mm)	Grit Size (Mesh)	Recommended Equipment	Part Number
T82 - Green	3 (76.2)	50	PG 830, PG 690, PG 540, PG 450	<b>589629601</b>
T83 - Red	3 (76.2)	100	PG 830, PG 690, PG 540, PG 450	<b>589629501</b>
T84 - Yellow	3 (76.2)	200	PG 830, PG 690, PG 540, PG 450	<b>589629401</b>

## Hiperflex FT80 Wet Transitional Pads

### HONING EPOXY OR CEMENT TERRAZZO, MARBLE & CONCRETE



- T80: use between metal and resin pad applications. Designed specifically for Husqvarna grinders. Use the adapter between the FT80 pad & grinding head plate in order to better follow the contour of the floor.

FT80 Wet Transitional Pads				
Name	Dots/Pad	Grit Size (Mesh)	Recommended Equipment	Part Number
FT82 7"	4	50	PG 450	<b>589633601</b>
FT83 7"	4	100	PG 450	<b>589633602</b>
FT84 7"	4	200	PG 450	<b>589633603</b>
Male/Female Foam Adapter 7"	-	-	PG 450	<b>589674102</b>
FT82 9"	5	50	PG 690, PG 540, PG 510	<b>589633801</b>
FT83 9"	5	100	PG 690, PG 540, PG 510	<b>589633802</b>
FT84 9"	5	200	PG 690, PG 540, PG 510	<b>589633803</b>
Male/Female Foam Adapter 9"	-	-	PG 690, PG 540, PG 510	<b>589674201</b>
FT82 11"	6	50	PG 830	<b>589634001</b>
FT83 11"	6	100	PG 830	<b>589634002</b>
FT84 11"	6	200	PG 830	<b>589634003</b>
Male/Female Foam Adapter 11"	-	-	PG 830	<b>589673901</b>



# Wet Tooling for Terrazzo, Marble & Concrete

## FP80 HiperFlex Wet Pads

HONING EPOXY OR CEMENT TERRAZZO, MARBLE & CONCRETE



- FP80: developed for fine polishing of epoxy or cement terrazzo, marble and concrete floors when using Husqvarna grinders. Optimum surface finish and productivity.

### FP80 HiperFlex Wet Pads

Name	Dots/Pad	Dimensions, in (mm)	Grit Size (Mesh)	Recommended Equipment	Part Number
FP84	4	7 (178)	200	PG 450	589633701
FP85	4	7 (178)	400	PG 450	589633702
FP86	4	7 (178)	800	PG 450	589633703
FP87	4	7 (178)	1,500	PG 450	589633704
FP88	4	7 (178)	3,000	PG 450	589633705
FP84	5	9 (229)	200	PG 690, PG 540, PG 510	589633901
FP85	5	9 (229)	400	PG 690, PG 540, PG 510	589633902
FP86	5	9 (229)	800	PG 690, PG 540, PG 510	589633903
FP87	5	9 (229)	1,500	PG 690, PG 540, PG 510	589633904
FP88	5	9 (229)	3,000	PG 690, PG 540, PG 510	589633905
FP84	6	11 (280)	200	PG 830	589634101
FP85	6	11 (280)	400	PG 830	589634102
FP86	6	11 (280)	800	PG 830	589634103
FP87	6	11 (280)	1,500	PG 830	589634104
FP88	6	11 (280)	3,000	PG 830	589634105

## P1280 3" Wet Resin Polishing Pads

HONING EPOXY OR CEMENT TERRAZZO, MARBLE & CONCRETE



- P1280 3": perfect for fine polishing of epoxy or cement terrazzo, marble and concrete floors.

### P1280 3"

Name/Color	Grit Size (Mesh)	Recommended Equipment	Part Number
P1282 - Green	50	PG 830, PG 690, PG 540, PG 450	582325905
P1283 - Black	100	PG 830, PG 690, PG 540, PG 450	582325904
P1284 - Red	200	PG 830, PG 690, PG 540, PG 450	582325901
P1285 - Yellow	400	PG 830, PG 690, PG 540, PG 450	582325903
P1286 - White	800	PG 830, PG 690, PG 540, PG 450	582325906
P1287 - Blue	1,500	PG 830, PG 690, PG 540, PG 450	582325907
P1288 - Grey	3,000	PG 830, PG 690, PG 540, PG 450	582325908

## P1280 5" Wet Resin Polishing Pads

HONING EPOXY OR CEMENT TERRAZZO, MARBLE & CONCRETE



- P1280 5": use for fine polishing of epoxy or cement terrazzo, marble and concrete floors.
- Designed for edging, stairs, etc.

### P1280 5"

Name	Grit Size (Mesh)	Recommended Equipment	Part Number
P1282	50	Handheld Grinders	589771901
P1283	100	Handheld Grinders	589771902
P1284	200	Handheld Grinders	589771903
P1285	400	Handheld Grinders	589771904
P1286	800	Handheld Grinders	589771905
P1287	1,500	Handheld Grinders	589771906
P1288	3,000	Handheld Grinders	589771907

# HIPERTROWEL™ Concrete Finishing



## Driver, Attachments & Chemicals

Product Description	Tool Information	Part Number
Pad Driver 14"	Driver + 4 bolts	593956821
Attachment A	Mounting plate + rotart bearing	596946822
Attachment B	Mounting plate + rotart bearing	593946823
Attachment C	Mounting plate + rotart bearing	593946825
Attachment D	Mounting plate + rotart bearing	593946842
Gyro Driver Barring	-	597408601
Hiperhard™	Floor Hardener	543087165
Hiperguard™	Floor Protection	543087448

## Diamond Tools

Product Description	Tool Information	Part Number
14 PT Metal Long-Life 30G	6 tools/pad	593946841
14 PT Metal Long-Life 50G	6 tools/pad	593846835
14 PT Metal Long-Life 100G	6 tools/pad	593846836
14 PT Semi Metal 30G - Purple	7 tools/pad	593946801
14 PT Semi Metal 50G - Green	7 tools/pad	593946813
14 PT Semi Metal 100G - Black	7 tools/pad	593946814
14 PT Semi Metal 200G - Red	7 tools/pad	593946815
14 PT Semi Metal 400G - Yellow	7 tools/pad	593946816
14 PT Resin 600G - Brown	16 tools/pad	593946817
14 PT Resin 800G - Grey	8 tools/pad	593946818
14 PT Resin 1,500G - Blue	8 tools/pad	593946819
14 PT Resin 3,000G - Dark Grey	8 tools/pad	593946820
HiperClean TRW - Silver	-	597279001

For rid-on trowel options, see page XX

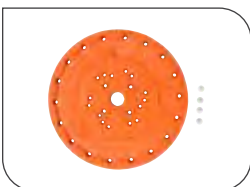

Pad Driver

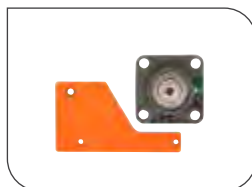

Attachment A



Attachment B



Attachment C



Attachment D

[CLICK HERE TO SEE IT IN ACTION!](#)

# HIPERTROWEL™ Concrete Finishing

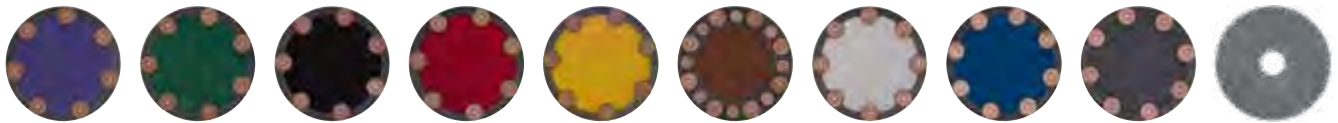

## Ride-on Trowel Options

Model Number	Rotor Dia.	No. of Pad Drivers	Pad Driver Dia.	Bearing Mount Ref.
<b>Allen</b>				
Edgers: 900/MP225/MP235	36"	8	14"	Attachment A
Pro 900 n-o/MP205/MP215	36"	8	14"	Attachment A
HP100/HP200/MP305/MP315/Pro 1200 (non-overlap)/SP400/SP450	46"	8	14"	Attachment B
HD530/HDX600/Pro1200/MSP415/425/450/455/470/430/435/440/445/460/SP 400 B/SP 425	46"	10	14"	Attachment B
<b>Husqvarna/Wacker</b>				
CRT 36	36"	8	14"	Attachment A
CRT 36 (Inner bolt hole spacing)	36"	8	14"	Attachment A
CRT 46 KHN	46"	8	14"	Attachment B
CRT 48 25K	48"	8	14"	Attachment B
CRT 48	48"	10	14"	Attachment B
CRT 48 (Inner bolt hole spacing)	48"	10	14"	Attachment B
CRT 60X	60"	12"	14"	Attachment D
<b>Whiteman/Multiquip</b>				
JTN/JWN	36"	8	14"	Attachment A
HTH/HHN/HTX/HHX/HTN	48"	10	14"	Attachment B
HTN (4-bladed model)	48"	8	14"	Attachment B
HTXD6i/HTXG6DF/HTX6H	48"	12	14"	Attachment C
STH/STX	60"	12	14"	Attachment C

[CLICK HERE TO SEE IT IN ACTION!](#)

# Scarifying Machine Tooling

## Star-Wheel Cutter

### CLEANING & REMOVAL



- Cleaning and removing epoxy paint, oil, grease, glue and thermoplastic road markings. Alternating wash and spacers on the four shafts of the drum enables user to achieve desired surface condition: very rough, medium or very fine. Available in ready-to-use kits or as spare parts.

Star-Wheel cutter			
Name	Diameter, in (mm)	Thickness, in (mm)	Part Number
Star Cutter Drum Kit (160 star wheels & 164 spacers)	2.4 (61)	0.08 (2)	<b>543040221</b>

## TCT-Wheel Cutter

### MODIFYING SURFACE STRUCTURE OF CONCRETE ASPHALT



- High-performance tool for modifying the surface structure of asphalt and concrete. Very high wear resistance (10 times more life). Alternating washer and spacers on the four shafts of the drum enables user to achieve desired surface condition: very rough, medium or very fine.

TCT-Wheel cutter			
Name	Diameter, in (mm)	Thickness, in (mm)	Part Number
TCT Cutter Drum (84 carbide wheels & 84 spacers)	2.3 (60)	0.3 (7.6)	<b>543040224</b>

## Replacement Wheels

### SCARIFYING MACHINE REPLACEMENT RINGS



Replacement Wheels			
Name	Diameter, in (mm)	Thickness, in (mm)	Part Number
Star Wheel (processed steel)	2.4 (61)	0.08 (2)	<b>543040214</b>
Toothed Wheel (processed steel)	2.4 (61)	0.3 (7.6)	<b>543040209</b>
Milling Wheel with Carbide Plates	-	-	<b>543040215</b>
Carbide Wheel	2.2 (59)	.25 (6.3)	<b>543040216</b>



# Cup Wheels for Surface Preparation

## Arrow Series Cup Wheel

### EPOXY, GLUE REMOVAL

- Arrow: high removal rate due to shape. Ideal for epoxy and glue removal.
- 20 grit size only.

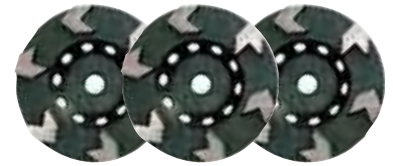

#### Arrow Series | Brazed

Size - Inches (mm)	Part Number
4 (105) x 5/8 - 11 THD	542793778
5 (125) x 5/8 - 11 THD	542793780
7 (180) x 5/8 - 11 THD	542793781
7 (180) x 7/8 - 5/8 - B w/DPH	501076501

## MW Dri Disc®

### CONCRETE, MASONRY, STONE

- Dri Disc: use as first step on concrete floor edges and stair steps. Can also be used as the first step in grinding of concrete counter tops.

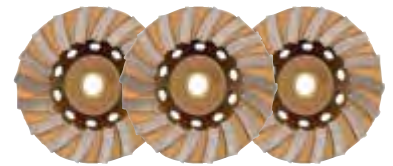

#### Dri Disc | Dry or Wet Cutting | Brazed

Size - Inches (mm)	Grit Size	Part Number
5 (127) x 5/8-11 THD - 18 Segment Turbo	60	542793564
5 (127) x 5/8-11 THD - 10 Segment Turbo	60	542793565
5 (127) x 5/8-11 THD - 18 Segment Turbo	120	542793251
5 (127) x 5/8-11 THD - 10 Segment Turbo	120	542793252
7 (178) x 5/8-11 THD - 18 Segment Turbo	60	542793255
7 (178) x 5/8-11 THD - 18 Segment Turbo	120	542793256

Total segment height is .200" diamond segment

## PCD Cup Wheels

### VINYLS, EPOXY, GLUE

- PCD: high removal rate, vinyl, epoxy, glue.



#### PCD Cup Wheels | Brazed

Size - Inches (mm)	Part Number
5 (127) x 7/8 - 5/8 B	585672501
7 (178) x 7/8 - 5/8 B	585300501

## Cup Wheel/PCD Adaptor

### VINYLS, EPOXY, GLUE

- Adaptor: high removal rate, vinyl, epoxy, glue.



#### Cup Wheel/PCD Adaptor

Size - Inches (mm)	Part Number
7/8 to 5/8-11 Adaptor CW	542751356
7/8 to 5/8-11 Adaptor PCD	501149101



# Additional Surface Prep Tooling

## Shaver Blades

### GENERAL PURPOSE BLADES FOR SHAVEMASTER SAW

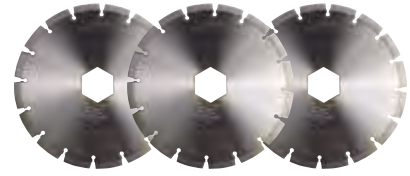

- Suitable for slurry cap removal, concrete planing, aggregate exposure and rough removal of epoxy coatings.

Shaver Blades		
Size - Inches (mm)	Name	Part Number
10 (250) x .110 x HEX	SM-5	542793778
10 (250) x .250 x HEX	Sm-5	542793780
10 (250) x .110 x HEX W/6 DP	SA-5	542793781
12 (305) x .110 x HEX	CT-5	501076501

## Rubbing Bricks

### CONCRETE, MASONRY, STONE BRICKS



- Handy Handle: comfortable, built-in handle for convenience and easier finishing
- Regular Flute: smaller bricks with flutes for added sharpness.
- Used for hand finishing concrete, masonry or stone

Rubbing Bricks   Dry	
Size - Inches (mm)	Part Number
<b>Handy Handle - 5/box</b>	
6 (152) x 3 x 1	542751588
8 (203) x 3.5 x 1.5	542751590
<b>Regular Flute - 6/box</b>	
6 (152) x 2 x 2	542751590
8 (203) x 2 x 2	542751591

SURFACE PREPARATION

## Tools for Single-Headed Grinders

### TDGH Grinding Heads

CURED CONCRETE, EPOXY, URETHANE

- TDGH (10 segments): fast removal.
- TDGH (20 segments): smooth finish.
- Smooth rough/patched floors, feather uneven joints/slab panels. These remove hard epoxies, urethane and other coatings/toppings; grind down bumps and raised or curled sidewalk panels.
- Two separate bolt hole patterns. Mount on a majority of grinding machines.



#### TDGH Grinding Heads | Dry or Wet Cutting

Size - Inches (mm)	Part Number
10 (254) - 10 segments	542751323
10 (254) - 20 segments	54251324

Total segment height: .300"

### GB Diamond Grinding Block

CONCRETE, EPOXY, NON-ABRASIVE MATERIALS

- GB-10: hard concrete, exposed aggregate.
- GB-20: general purpose grinding.
- Remove thin layers of coatings and toppings without clogging. They smooth uneven, rough or patched slabs as well as level and feather uneven joints/slab panels.
- Removal rates up to five times faster than grinding stones. Six per machine are required. Attaches to standard accessory disc.



#### GB Diamond | Dry or Wet Cutting | Brazed

Size - Inches (mm)	Part Number
GB-10	542751320
GB-20	542751321
Additional wooden wedges (sold individually)	542751322

### TCS Grinding Stones

COARSE GRIT, MEDIUM GRIT, FINE GRIT

- TCS-10: fast removal/grinding of excess or rough concrete, uneven joints, rain marks or stains on concrete, exposed aggregate and rough grinding of terrazzo floors.
- TCS-24: medium finish grinding of terrazzo, concrete, stone, brick, exposed aggregate surfaces.
- TCS-80: smooth finish grinding of terrazzo, concrete, stone, brick, exposed surfaces.
- Package quantity is 6 per box, includes wooden wedges. Six per machine are required.



#### TCS Grinding Stones | Dry or Wet Cutting

Size - Inches (mm)	TCS-10 Part No.	TCS-24 Part No.	TCS-80 Part No.
GB-10	542751334	542751335	542751336
Additional wooden wedges (sold individually)	-	-	542751322

# Husqvarna HIPERFLOOR



Concrete is already one of the most durable surfaces known to man. By mechanically refining the surface through grinding, polishing and chemical treatments, we can bring the surface to a whole new level of beauty, functionality and strength. With different specified processes, a flooring solution can be tailored to fit any requirement – aesthetics, gloss and price. It is only by using Husqvarna equipment, diamond tools and concrete chemicals that a polished concrete floor can truly be called HIPERFLOOR.

## Good Investment & Going Green:

### Environmentally Sensible

The HIPERFLOOR process transforms existing concrete substrate into a wear-resistant floor by mechanically refining the concrete. This extends the lifetime of the floor and reduces the volume of waste compared to other flooring options like epoxy, linoleum or vinyl.

### Hard and Resistant

With the HIPERFLOOR method, we take an already hard material and increase the surface density and abrasion resistance to a level where the concrete surface is extremely resistant to wear and marking.

### Durable and Cost Efficient

The HIPERFLOOR concrete polishing system significantly increases durability and reduces life cycle maintenance costs. The absence of a surface coating reduces costs traditionally associated with flooring installations. The result is a smoother surface with reduced cleaning costs.

### Light Reflective

In addition to reduced maintenance costs, there is also the added benefit of reduced lighting requirements, a result of the higher light reflectivity of the surface.



### Industrial Finish

A low-gloss finish customized for industrial floors. This process is primarily an indoor application targeting large areas such as warehouses and department stores where flooring functionality is of primary concern. The result is a hard-wearing floor that offers a safer and cleaner environment.

- Minimal lifetime cost
- Withstands tough use
- Slip-resistant
- Resistant to spills, abrasion, oils and dusting
- Easy to clean



### Commercial Finish

A medium-gloss finish for semi-exposed and low-exposed aggregate floors. Commercial finish is an indoor application for retail areas, shop fronts and indoor public spaces. The result is a floor that offers functionality and low maintenance but is still aesthetically pleasing.

- Easy to clean and maintain
- Resistant to wear and spills
- Abrasion-resistant
- Slip-resistant
- Minimal lifetime cost



### Premium Finish

A decorative, high-gloss finish for exposed aggregate floors. premium finish is an indoor application for showrooms, high-end real estate and areas where aesthetic properties that include flatness and reflectivity of the floor are a top priority. The result is a surface that shines and offers exceptional durability.

- Reflective and decorative finish
- Floor flatness
- High quality and durability
- Hygienic and easy to clean
- Resistant to abrasion

## HIPERFLOOR Return on Investment:

### 15 Year Life Cycle Cost – Indexed

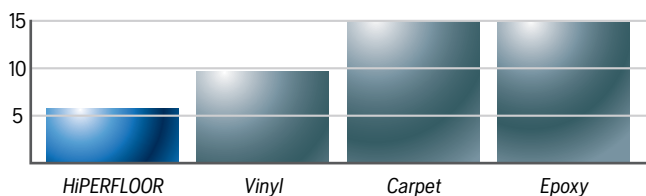

### 5 Year Maintenance Cost

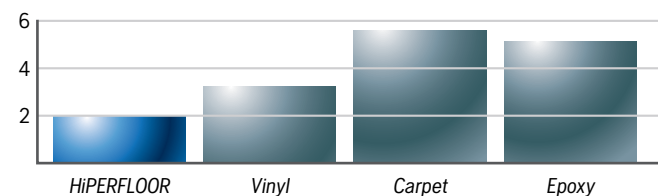





SURFACE  
PREPARATION

# TAKE CARE OF DUST AND SLURRY IN A SMART, EASY AND EFFICIENT WAY

Concrete dust and slurry need to be removed in a safe and efficient way to protect you and your team from unhealthy dust exposure. With Husqvarna, you get access to guidance, knowledge and a broad, fully integrated range of highly efficient equipment for dust and slurry management, enabling you to comply with rules and regulations without compromising your productivity. By combining our expertise in concrete cutting, drilling and grinding with the foremost technology in dust and slurry management, Husqvarna has a unique ability to provide you with easy-to-use solutions. Handling the dust and slurry more efficiently means a better way of working.



## What is a Husqvarna HEPA H13 filter?

HEPA is an acronym for High Efficiency Particulate Air filters. The strict HEPA standard (EN 1822-1) is divided into different levels (E10 to H14) depending on filtration efficiency. Husqvarna applies level H13, which is designed to separate up to 99.95% of the particles between 0.15 and 0.30 µm in size. This particle size is the hardest to separate – both larger and smaller particles are easier to capture in a filter. In addition, Husqvarna tests each filter individually before delivery to approve that the filter really fulfills the HEPA H13 standard.

## Range Overview

Husqvarna's range of equipment for dust and slurry management covers all needs and applications within the construction industry – from the compact 1-phase HEPA dust extractors and efficient slurry vacuums to the big, powerful 3-phase HEPA dust extractors for heavy-duty jobs. The easily portable air scrubbers equipped with HEPA filters complete the setup for maximum workplace safety.



Drilling															
Power Cutters															
Wall Saws															
Angle Grinders															
Masonry Saws															
Floor Grinders															
Soff-Cut®															







DUST & SLURRY

	A 2000	A 600
Drilling	●	●
Power Cutters	●	●
Wall Saws	●	●
Angle Grinders	●	●
Masonry Saws	●	●
Floor Grinders	●	●

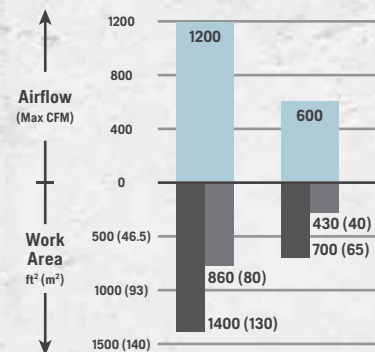

\*NOTE ON WORK AREA - Please note, Work area calculation based on a ceiling height of 10ft (2.5 m).

■ At 6 air changes/h    ■ At 10 air changes/h

With Husqvarna, you get access to guidance, knowledge and a broad range of powerful equipment and diamond tools for almost any type of job, all available in one place. We offer a choice of systems designed around you, to help you work smarter and finish any job as quickly, efficiently and profitably as possible.

Our complete offering also includes a fully integrated range of highly efficient equipment for dust and slurry management, enabling you to comply with most rules and regulations without compromising your productivity.

By combining our industry expertise in concrete cutting, drilling and grinding with the foremost technology in dust and slurry management, Husqvarna has a unique ability to provide you with easy-to-use solutions that deliver continuous high efficiency over a long time span. Handling the dust and slurry more efficiently means a better way of working.

In addition, our trained service technicians will help keep your dust and slurry equipment in top working condition. Our technicians follow correct service procedures and always use individually tested Husqvarna original HEPA filters for replacement. It is important to maintain your equipment to ensure performance, safety and efficiency throughout your equipment's life.

The H-classification is an international standard that certifies the entire product, not only the filters. The international standard for testing wet and dry extractors, dust extractors (IEC 60335-2-69, EN-60335-2-69), is classified into three categories – L for low, M for medium and H for high – where the H category is the most stringent, not to be confused with the "H" in HEPA H13. Certified Husqvarna dust extractors (Husqvarna S13, S26, S36 and T7500) meet the high (H) standard since it's the most stringent and suitable when working with hazardous material such as silica dust.

# Husqvarna T-Line Vacuums

## Applications

- Large-scale projects that demand substantial dust extraction.
- Grinding dust and demolition materials in a wide variety of applications.

## Benefits

- Three separate filtering stages collect dust from the heaviest to the finest dust particles.
- Individually tested and certified HEPA filters rated at 99.99% @ 0.3 microns.
- Longopac® bag hose system ensures simple and safe dust bag changes.
- Jet pulse filter cleaning system ensures high continuous airflow due to easy and efficient cleaning of main filter without opening the machine.



Dust & Slurry Model	T 18000	T 10000
Part No. (additional items, see below chart for details)	967663601	967663701

## Technical Specifications

Power, hp (kW)	24.1 (18)	17 (12.6)
Voltage, V	480	480
Max rated current, A	28	21
Power supply	3-phase	3-phase
Distribution box	Yes	Yes
Plug size (male)	HBL460B7W	CS8175
Plug size (female)	HBL460R7W	CS8169
Airflow, CFM	710	48
Water lift, in (mm)	140 (3,556)	120 (3,048)
Max vacuum, kPa	30	28
Suction inlet diameter, in (mm)	4 (100)	3 (76)
Number of HEPA filters*	4	3
Weight, lbs (kgs)	900 (408)	740 (336)
Dimensions (L x W x H) in, (mm)	55 x 31 x 71 (1,400 x 788 x 1,840)	55 x 29 x 68 (1,400 x 736 x 1,727)

\*NOTE: Every single HEPA filter is individually tested and certified at filtration rate 99.99% at 0.3 microns.

Includes 3" x 33' hose & 4" female 2" x 3" male camlock Y-pipe & 60 amp distribution box.

Includes: 3" x 33' hose and complete floor tool kit including 2" x 25' crushproof hose, wand & floor tool, 50 amp distribution box. Female & male 3"-2" camlock reducers.

**RECOMMENDED EQUIPMENT**

**SEE PAGES 226 & 227**

# Husqvarna T-Line Vacuums

## Applications

- Large-scale projects that demand substantial dust extraction.
- Grinding dust and demolition materials in a wide variety of applications.

## Benefits

- Three separate filtering stages collect dust from the heaviest to the finest dust particles.
- Individually tested and certified HEPA filters rated at 99.99% @ 0.3 microns.
- Longopac® bag hose system ensures simple and safe dust bag changes.
- Jet pulse filter cleaning system ensures high continuous airflow due to easy and efficient cleaning of main filter without opening the machine.



Dust & Slurry Model	T 8600	T 8600 P	T 7500
Part No. (additional items, see below chart for details)	967664201	967664801	967664101

## Technical Specifications

Power, hp (kW)	11.5 (8.6)	18 (14)	101 (75)
Voltage, V	480	NA	230
Max rated current, A	11.9	NA	24.2
Power supply	3-phase	Kawasaki (Propane)	3-phase
Oil capacity, qt (L)	NA	1.8 (1.7)	NA
Fuel	NA	Vapor Propane	NA
Max RPM	NA	3,500	NA
Distribution box	Yes	NA	Yes
Plug size (male)	CS8175	NA	HBL4100B9W
Plug size (female)	CS8169	NA	HBL4100R9W
Airflow, CFM	353	410	353
Water lift, in (mm)	110 (2,794)	115 (2,921)	110 (2,794)
Max vacuum, kPa	28	29	28
Suction inlet diameter, in (mm)	3 (76)	3 (76)	3 (76)
Number of HEPA filters*	2	2	2
Weight, lbs (kgs)	454 (206)	628 (285)	454 (206)
Dimensions (L x W x H) in, (mm)	49 x 27 x 69 (1,245 x 686 x 1,753)	49 x 27 x 69 (1,245 x 686 x 1,753)	49 x 27 x 69 (1,245 x 686 x 1,753)

\*NOTE: Every single HEPA filter is individually tested and certified at filtration rate 99.99% at 0.3 microns.

Includes: 3" x 33' hose and complete floor tool kit including 2" x 25' crushproof hose, wand, floor tool & 50 amp distribution box. Female & male 3"-2" camlock reducers.

Includes: 3" x 33' hose and complete floor tool kit including 2" x 25' crushproof hose, wand & floor tool. Female & male 3"-2" camlock reducers.

Includes: 3" x 33' hose and complete floor tool kit including 2" x 25' crushproof hose, wand, floor tool & 100 amp distribution box. Female & male 3"-2" camlock reducers.

**RECOMMENDED EQUIPMENT**

**SEE PAGES 226 & 227**



# Husqvarna T-Line Vacuums

## Applications

- Grinding dust in a wide variety of applications.
- Wet or dry applications.
- T 4000 P Soft-Cut Kit is specialized for Soff-Cut applications with an integrated pre-separator, which captures up to 90% of the dust before it reaches the pre-filter.

## Benefits

- Unique double-shell cyclone technology enables constant high air flow and high productivity, leaving less dust on the floor.
- Can be raised and lowered to aid transport.
- Individually tested and certified HEPA filters rated at 99.99% @ 0.3 microns.
- Longopac® bag hose system ensures simple and safe dust bag changes.



Dust & Slurry Model	T 4000 Petrol	T 4000 Petrol Soff-Cut Kit
Part No. (additional items, see below chart for details)	967849301	967973301

## Technical Specifications

Power, hp (kW)	101 (7.5)	101 (7.5)
Max RPM	3500	3500
Fuel	Unleaded 86 octane or higher	Unleaded 86 octane or higher
Power supply	Honda (Gas)	Honda (Gas)
Oil capacity, qt (L)	1.2 (1.1)	1.2 (1.1)
Fuel tank capacity, gal (L)	0.58 (2.1)	0.58 (2.1)
Airflow, CFM	285	285
Water lift, in (mm)	104 (2,642)	104 (2,642)
Max vacuum, kPa	26	26
Suction inlet diameter, in (mm)	2 (51)	2 (51)
Number of HEPA filters*	2	2
Weight, lbs (kgs)	453 (203)	453 (203)
Dimensions (L x W x H) in, (mm)	33 x 24.5 x 60 (840 x 620 x 1,500)	63 x 30 x 63 (1,600 x 762 x 1,600)

\*NOTE: Every single HEPA filter is individually tested and certified at filtration rate 99.99% at 0.3 microns.

Includes: 2.5" x 33' hose and complete floor tool kit including 2" x 25' crushproof hose, wand & floor tool.

Includes: 2.5" x 33' hose, 2.5" x 8" hose with 3" female camlock inlet shut off adaptor and complete floor tool kit.

**RECOMMENDED EQUIPMENT**

**SEE PAGES 226 & 227**

# Husqvarna DC-Line Vacuums

## Applications

- Large-scale projects that demand substantial dust extraction.
- Grinding dust and demolition materials in a wide variety of applications.

## Benefits

- Three separate filtering stages collect dust from the heaviest to the finest dust particles.
- Individually tested and certified HEPA filters rated at 99.99% @ 0.3 microns.
- Longopac® bag hose system ensures simple and safe dust bag changes.
- Unique double shell cyclone technology and automatic filter cleaning.



Dust & Slurry Model	DC 6000
Part No. (additional items, see below chart for details)	967625003

## Technical Specifications

Power, hp (kW)	10 (7.4)
Voltage, V	380-480
Max rated current, A	16
Power supply	3-phase
Distribution box	Yes
Plug size (male)	CS8175
Plug size (female)	Amphenol
Airflow, CFM	406
Water lift, in (mm)	84 (2,134)
Max vacuum, kPa	22
Suction inlet diameter, in (mm)	3 (76)
Number of HEPA filters*	1
Weight, lbs (kgs)	640 (290)
Dimensions (L x W x H) in, (mm)	49 x 30 x 75 (1,245 x 766 x 1,900)

\*NOTE: Every single HEPA filter is individually tested and certified at filtration rate 99.99% at 0.3 microns.

Includes 3' x 33' hose, floor tool including 2' x 30' hose.

**RECOMMENDED EQUIPMENT**

**SEE PAGES 226 & 227**



# Husqvarna S-Line Vacuums

## Applications

- 1-phase machines for all construction, abatement and restoration jobs, as well as electric power tools.

## Benefits

- Three separate filtering stages.
- Jet Pulse cleaning of the conical main filter ensures dust is continuously collected throughout the day.
- Longopac® collecting bag enables the machine to be emptied quickly and simply.
- Individually tested and certified HEPA filters rated at 99.99% @0.3 micron.



Dust & Slurry Model	S 36 230 V	S 36 120 V
Part No. (additional items, see below chart for details)	967663802	967663801

## Technical Specifications

Power, hp (kW)	4.8 (3.5)	3.2 (2.4)
Voltage, V	230	120
Max rated current, A	15	20
Power supply	1-phase	1-phase
Distribution box	Yes (30 amp out)	No
Plug size (male)	CS8269	HBL5366C
Plug size (female)	L6-30	-
Airflow, CFM	353	285
Water lift, in (mm)	100 (2,540)	80 (2,032)
Max vacuum, kPa	28	22
Suction inlet diameter, in (mm)	2 (51)	2 (51)
Number of HEPA filters*	3	3
Weight, lbs (kgs)	140 (64)	140 (64)
Dimensions (L x W x H) in, (mm)	33 x 24.5 x 60 (840 x 620 x 1,500)	33 x 24.5 x 60 (840 x 620 x 1,500)

\*NOTE: Every single HEPA filter is individually tested and certified at filtration rate 99.99% at 0.3 microns.

Includes: 2" x 25' hose, 2.5" x 33' hose, wand and floor tool.

Includes: 2" x 25' hose, 2.5" x 33' hose, wand and floor tool.

RECOMMENDED EQUIPMENT

SEE PAGES 226 & 227

# Husqvarna S-Line Vacuums

## Applications

- 1-phase machines for all construction, abatement and restoration jobs, as well as electric power tools.

## Benefits

- Three separate filtering stages.
- Jet Pulse cleaning of the conical main filter ensures dust is continuously collected throughout the day.
- Longopac® collecting bag enables the machine to be emptied quickly and simply.
- Individually tested and certified HEPA filters rated at 99.99% @0.3 micron.



Dust & Slurry Model	S 36 Propane	S 26
Part No. (additional items, see below chart for details)	967808001	967663901

## Technical Specifications

Power, hp (kW)	10.6 (7.6)	3.2 (2.4)
Voltage, V	NA	120
Max rated current, A	NA	20
Max RPM	3,500	NA
Fuel	Unleaded 86 octance or higher	NA
Power supply	Honda (Propane)	1-phase
Distribution box	NA	No
Plug size (male)	NA	HBL5366C
Plug size (female)	NA	-
Oil capacity, qt (L)	1.2 (1.1)	NA
Fuel tank capacity, gal (L)	0.58 (2.1)	NA
Airflow, CFM	285	258
Water lift, in (mm)	125 (3,175)	100 (2,540)
Max vacuum, kPa	NA	24
Suction inlet diameter, in (mm)	2 (51)	2 (51)
Number of HEPA filters*	2	2
Weight, lbs (kgs)	190 (86)	105 (48)
Dimensions (L x W x H) in, (mm)	33 x 24.5 x 60 (840 x 620 x 1,500)	26 x 21.5 x 50.2 (756 x 546 x 1,275)

\*NOTE: Every single HEPA filter is individually tested and certified at filtration rate 99.99% at 0.3 microns.

Includes: 2' x 25' hose, 25" x 33" hose, 25"-3" hose cuff, floor tool, wand, battery and propane tank.

Includes 25" x 25' hose, wand and floor tool.

**RECOMMENDED EQUIPMENT**

**SEE PAGES 226 & 227**

# Husqvarna S-Line Vacuums

## Applications

- 1-phase machines for all construction, abatement and restoration jobs, as well as electric power tools.

## Benefits

- Three separate filtering stages.
- Jet Pulse cleaning of the conical main filter ensures dust is continuously collected throughout the day. (S 13)
- Longopac® collecting bag enables the machine to be emptied quickly and simply. (S 13)
- Automatic filter cleaning by shaking the filter during operation for continuous air-flow. (S 11)
- Individually tested and certified HEPA filters rated at 99.99% @0.3 micron.



Dust & Slurry Model	S 13	S 11
Part No. (additional items, see below chart for details)	967664001	970466602

## Technical Specifications

Power, hp (kW)	1.6 (1.2)	1.9 (1.4)
Voltage, V	120	120
Max rated current, A	10	11
Power supply	1-phase	1-phase
Distribution box	No	No
Plug size (male)	HBL5266C (male)	-
Plug size (female)	-	-
Airflow, CFM	129	157
Water lift, in (mm)	100 (2,540)	93 (2,362)
Max vacuum, kPa	24	23
Suction inlet diameter, in (mm)	1.5 (38)	1 (25.4)
Number of HEPA filters*	1	1
Weight, lbs (kgs)	66 (30)	35 (16)
Dimensions (L x W x H) in, (mm)	26 x 16 x 43 (680 x 400 x 1,100)	17 x 15 x 20.8 (440 x 380 x 530)

\*NOTE: Every single HEPA filter is individually tested and certified at filtration rate 99.99% at 0.3 microns.

Includes 15' x 13.5' hose, wand, floor tool and longopac bag.

Includes 15' x 13.5' hose, wand and floor tool along with a 6 mil, 4 gallon disposable poly bag.

**RECOMMENDED EQUIPMENT**

**SEE PAGES 226 & 227**

# Husqvarna W-Line Vacuums

## Applications

- Toughest jobs a slurry vacuum can handle.
- Manage liquids such as concrete slurry, oils and machining coolants.

## Benefits

- Integral stainless steel strainer screens gravel from the slurry to protect the pump impeller (W 70 P only).
- Patented filter/float system provides maximum airflow and reliable wet shut-off in case of overflow.
- Pumping out can take place at the same time as suction, recycling the water through (W 250 P only).
- Powerful evacuation pump is capable of pumping the slurry 33 ft vertically or 656 ft horizontally (W 70 P only).



Dust & Slurry Model	W 70 P	W 70	W 250 P
Part No. (additional items, see below chart for details)	967994701	967702003	967702104

## Technical Specifications

Power, hp (kW)	1.6 (1.2)	1.6 (1.2)	2.1 (1.55)
Voltage, V	120	120	120
Max rated current, A	16.7 (10A vac & 6.7A pump)	7	13 (10A vac & 3A pump)
Power supply	1-phase	1-phase	1-phase
Gallon capacity, gal (L)	15 (56)	15 (56)	7.5 (28)
Airflow, CFM	118	118	160
Water lift, in (mm)	90	90	100
Pump waterlift, in (mm)	30	NA	20
Pump discharge, gal/min (L/min)	63 (238)	NA	39
Weight, lbs (kgs)	99 (45)	99 (34)	59 (27)
Dimensions (L x W x H) in, (mm)	24 x 22 x 49 (600 x 570 x 1,250)	24 x 22 x 49 (600 x 570 x 1,250)	21 x 20.5 x 35.8 (530 x 520 x 910)

\*NOTE: Every single HEPA filter is individually tested and certified at filtration rate 99.99% at 0.3 microns.

Includes 15" x 10' hose, 3-piece wand & floor tool.

Includes 10' hose, 15" wand & 15" floor tool.

Includes 10' hose, 15" wand, 15" floor tool & 1 disposable wet bag.

**RECOMMENDED EQUIPMENT**

**SEE PAGES 226 & 227**

# Husqvarna C-Line Pre-Separators

## Applications

- Use when a large amount of dust will be produced.

## Benefits

- Additional separation stage to capture as much dust as possible before it reaches the dust extractor.
- Increases efficiency in the separation of dust from the air stream, improves filter performance and significant reduction in the frequency of filter maintenance.
- Contributes to higher airflow, faster pick-up and extended motor life.



Dust & Slurry Model	C 5500	C 3000
Part No. (additional items, see below chart for details)	967664601	967664501

## Technical Specifications

Volume, gal (L)	26 (98)	10 (38)
Weight, lbs (kgs)	101 (46)	49 (22)
Dimensions (L x W x H) in, (mm)	33 x 24.5 x 60 (840 x 620 x 1,500)	26 x 21.5 x 50.2 (756 x 546 x 1,275)
	<small>Includes: 3" x 33' hose assembly.</small>	<small>Includes: 3" x 8' hose assembly.</small>

DUST & SLURRY

**RECOMMENDED EQUIPMENT**

**SEE PAGES 226 & 227**



# Husqvarna A-Line Air Filter

## Applications

- Ideal complement to dust and slurry management equipment as well as in other applications where the air quality is essential.
- Can be used as a negative air machine.

## Benefits

- Powerful, super-quiet two-speed motor is capable of delivering thousands of cubic meters of clean air every hour, all workday long.
- A pre-filter made of pleated polyester catches the larger dust particles before the air enters the individually tested HEPA filter ensuring 99.97% efficiency at 0.3 microns.



Dust & Slurry Model	A 2000	A 600
Part No.	967672204	967664401

## Technical Specifications

Power, hp (kW)	0.80 (0.60)	0.50 (0.37)
Voltage, V	120	120
Max rated current, A	4.9	3.2
Power supply	1-phase	1-phase
Airflow, CFM	600/1200	300/600
Sound level, 2sp/db (a)	60/68	58/65
Weight, lbs (kgs)	150 (68)	60 (27)
Dimensions (L x W x H) in, (mm)	28.5 x 16.7 x 32 (724 x 424 x 810)	18.3 x 15 x 18.3 (465 x 384 x 465)

**RECOMMENDED EQUIPMENT**

**SEE PAGES 226 & 227**

# Husqvarna Dust Collection Cross Reference Chart

DRY APPLICATIONS	T LINE					DC LINE	C LINE		S LINE			A LINE			
	Equipment	T 18000	T 10000	T 8600/P	T 7500		T 4000 P	DC 6000	C 5500	C 3000	S 36	S 26	S 13/S 11	A 2000	A 600
<b>FLOOR GRINDING, SCARIFYING AND POLISHING</b>															
PG 830	✓	✓	✓	✓	✓ (230v)		✓	✓					+	+	
PG 830 RC	✓	✓	✓				✓	✓					+	+	
PG 830 S	✓	✓	✓				✓	✓					+	+	
PG 690	✓	✓	✓	✓	✓ (230v)		✓	✓					+	+	
PG 690 RC	✓	✓	✓				✓	✓					+	+	
PG 690 Propane	✓	✓	✓				✓	✓					+	+	
PG 540	✓	✓	✓				✓	✓	✓	✓			+	+	
PG 510										✓			+	+	
PG 450									✓	✓	✓		+	+	
PG 400									✓	✓			+	+	
PG 400 Petrol						✓							+	+	
PG 280									✓	✓	✓		+	+	
<b>DRY CORE DRILLING</b>															
DM 400/430											DB ✓		+	+	
DM 280											DB ✓		+	+	
DM 230											DEA/DB ✓		+	+	
DM 220											DB ✓		+	+	
<b>DRY POWER CUTTING</b>															
K 4000											VA ✓		+	+	
<b>+DRY MASONRY SAWING</b>															
MS 360											VK ✓		+	+	
MS 360 G											VK ✓		+	+	
<b>SOFF-CUT DUST SHIELD WITH 3" OUTLET</b>															
Soff-Cut® 5000	✓	✓	✓	✓	✓		✓	✓	✓	✓			+	+	
Soff-Cut® 4200	✓	✓	✓	✓	✓		✓	✓	✓	✓			+	+	
Soff-Cut® 4000	✓	✓	✓	✓	✓		✓	✓	✓	✓			+	+	
Soff-Cut® 2000	✓	✓	✓	✓	✓		✓	✓	✓	✓			+	+	
Soff-Cut® 2500	✓	✓	✓	✓	✓		✓	✓	✓	✓			+	+	
<b>SOFF-CUT DUST SHIELD WITH 2" OUTLET</b>															
Soff-Cut® 150								✓	✓	✓					
Soff-Cut® 150 E								✓	✓	✓					
<b>OTHER APPLICATIONS</b>															
Angle Grinder (up to 5")												DH ✓	+	+	
Angle Grinder (up to 9")												DH ✓	+	+	
Drills												DBB ✓	DBB ✓	+	+
Hammers									DBB ✓	DBB ✓				+	+

✓ Attached to machine + Part of solution **DB**-Dust Bug **DH** - Dust Hood **DBB** - Dust Boot **DEA** - Dust Extraction Attachment **VA**-Vac Attachment **VK** - Vac Kit

# Husqvarna Slurry Collection Cross Reference Chart

WET APPLICATIONS	W LINE			WATER SOURCE
Equipment	W 70 P	W 70	W 250 P	WATER SUPPLY
<b>WALL SAWING</b>				
WS 482 HF	Slurry Collector ✓	Slurry Collector ✓	Slurry Collector ✓	
WS 440 HF	Slurry Collector ✓	Slurry Collector ✓	Slurry Collector ✓	
WS 220	Slurry Collector ✓	Slurry Collector ✓	Slurry Collector ✓	
<b>WIRE SAWING</b>				
CS 2512	+	+	+	
CS 10	+	+	+	
<b>FLOOR SAWING</b>				
FS 7000 D/DL	+	+	+	Water pump kit ✓
FS 5000 D	+	+	+	Water pump kit ✓
FS 3500 E/G	+	+	+	Water pump kit ✓
FS 500 Series	+	+	+	Water pump kit ✓
FS 400 Series	+	+	+	Water pump kit ✓
FS 309	+	+	+	Water pump kit ✓
<b>WET CORE DRILLING</b>				
DM 700	Slurry Collector ✓ / Slurry Collector+	Slurry Collector ✓ / Slurry Collector+	Slurry Collector ✓ / Slurry Collector+	
DM 400/430	Slurry Collector ✓ / Slurry Collector+	Slurry Collector ✓ / Slurry Collector+	Slurry Collector ✓ / Slurry Collector+	WT 15 / PWT 15
DM 280	Slurry Collector ✓ / Slurry Collector+	Slurry Collector ✓ / Slurry Collector+	Slurry Collector ✓ / Slurry Collector+	WT 15 / PWT 15
DM 230	Slurry Collector ✓ / Slurry Collector+	Slurry Collector ✓ / Slurry Collector+	Slurry Collector ✓ / Slurry Collector+	WT 15 / PWT 15
DM 220	Slurry Collector ✓ / Slurry Collector+	Slurry Collector ✓ / Slurry Collector+	Slurry Collector ✓ / Slurry Collector+	WT 15 / PWT 15
<b>WET POWER CUTTING</b>				
K 770	+	+	+	WT 15 / PWT 15 / KV K 760 ✓
K 970	+	+	+	WT 15 / PWT 15 / KV K 970 / KV 1270 ✓
K 1270	+	+	+	WT 15 / PWT 15 / KV K 970 / KV 1270 ✓
K 4000	+	+	+	WT 15 / PWT 15
K 7000	+	+	+	WT 15 / PWT 15
<b>WET MASONRY SAWING</b>				
MS 360	+	+	+	Water pump ✓
MS 360 G	+	+	+	Water pump ✓
MS 610	+	+	+	Water pump ✓

✓ Attached to machine + Part of solution **DB**-Dust Bug **DH** - Dust Hood **DBB** - Dust Boot **DEA** - Dust Extraction Attachment **VA**-Vac Attachment **VK** - Vac Kit

Learn more about OSHA Silica Dust Regulation Compliance with Husqvarna at: [www.husqvarnacp.com/us/silica](http://www.husqvarnacp.com/us/silica)

# Pullman Holt HEPA Drum Vacuum

## Applications

- 102 Big Red vacuum has plenty of capacity for big jobs.

## Benefits

- The 102 Big Red handles 7.2 bushels of dry capacity and 55 gal in wet recovery.
- "Never clog" filter bag.



Dust & Slurry Model	102 BIG RED
Part No.	967792401*
Part No. (motor head)	591218901
Part No. (55 gal drum)	591397501
Part No. (drum HEPA adapter with tools)	591221101
Part No. (55 gal drum dolly)	591385601

## Technical Specifications

Power, hp (kW)	2 (1.5)
Voltage, V	110
Max rated current, A	11
Power supply	1-phase
Gallon capacity, gal (L)	55 (208)
Airflow, CFM	110
Water lift, in (mm)	105 (2,667)
Weight, lbs (kgs)	150 (68)
Dimensions (L x W x H) in, (mm)	28 x 28 x 44 (711 x 711 x 1,118)

\*Includes 15" x 10" spacer, float, wet pan, squeegee tool, wand hose, floor tool brush, and crevice tool.

RECOMMENDED EQUIPMENT

GRINDERS | CORE DRILLS | POWER CUTTERS

# Pullman Holt HEPA Dry Vacuums

## Applications

- 102 Dry is the workhorse for the abatement, remediation and restoration industries.
- 86 Dry is rugged enough to handle tough jobs in tight, congested areas.
- Dry vacuum models can be used as a wet vacuum with a wet upgrade kit (sold separately).

## Benefits

- Filter in the 102 and 86 is made from a single piece of high-grade HEPA media to eliminate the possibility of leaks.
- "Never clog" filter bag.



Dust & Slurry Model	102 DRY	45 DRY	86 DRY
Part No.	967792201*	967850801*	967792301*
<b>UPGRADE DRY VACUUM TO A WET VACUUM</b>			
Part No. (wet upgrade kit)	590945701**	591222101 (Limited stock)***	590945801**

## Technical Specifications

Power, hp (kW)	2 (1.49)	2 (1.49)	1 (.75)
Voltage, V	110	110	110
Max rated current, A	11	11	7.2
Power supply	1-phase	1-phase	1-phase
Gallon capacity, gal (L)	12 (45)	10 (38)	5 (19)
Airflow, CFM	110	110	96
Water lift, in (mm)	105 (2,667)	105 (2,667)	85 (2,159)
Weight, lbs (kgs)	68 (31)	38 (17)	42 (19)
Dimensions (L x W x H) in, (mm)	22 x 23 x 36 (559 x 584 x 914)	16 x 16 x 28 (406 x 406 x 711)	18 x 18 x 28 (457 x 457 x 711)

\*Dry model comes with wand, hose, floor tool brush, dusting brush, crevice tool & paper filter bag.

\*\*Wet upgrade kit includes spacer, float, wet pan and squeegee floor tool.

\*\*\*45HEPA W/D conversion kit (limited stock).

RECOMMENDED EQUIPMENT

GRINDERS | CORE DRILLS | POWER CUTTERS



# Pullman Holt Wet Vacuums

## Applications

- Available in dry only models, but it can be upgraded to a wet/dry vacuum front with squeegee. (sold separately)

## Benefits

- 2 hp motor exceeds airflow and pick-up.
- Compact, low center of gravity ensures no tipping, easy handling, transporting and storage.
- Low noise allows for use in sound sensitive public areas such as schools and hospitals.



Dust & Slurry Model	45-20P WET	45-20POV
Part No.	967943301*	967850803**
<b>UPGRADE DRY VACUUM TO A WET VACUUM</b>		
Part No. (wet upgrade kit)	593034701	593034701

## Technical Specifications

Power, hp (kW)	2 (1.49)	2 (1.49)
Voltage, V	110	110
Max rated current, A	11	11
Power supply	1-phase	1-phase
Gallon capacity, gal (L)	20 (76)	20 (76)
Airflow, CFM	110	110
Water lift, in (mm)	105 (2,667)	105 (2,667)
Weight, lbs (kgs)	67 (30)	42 (19)
Dimensions (L x W x H) in, (mm)	41 x 22 x 24 (1,041 x 559 x 610)	41 x 22 x 24 (1,041 x 559 x 610)

\*Includes wand, hose, floor tool brush, dusting brush, crevice tool and paper filter bag.  
\*\*Includes hose and discharge hose.

RECOMMENDED EQUIPMENT

GRINDERS | CORE DRILLS | POWER CUTTERS

# Pullman Holt Canister Dry Vacuums

## Applications

- Professional dry cleaning applications.

## Benefits

- Low profile makes it extremely maneuverable and easy to use.
- Individually tested and certified HEPA filter.



Dust & Slurry Model	390
Part No.	967850701
POWER HEAD	
Part No. (390 electric power head)	591212301
Part No. (390 air powered head)	591208101

## Technical Specifications

Power, hp (kW)	1.5 (1.1)
Voltage, V	110
Power supply	1-phase
Airflow, CFM	100
Water lift, in (mm)	97
Weight, lbs (kgs)	18 (8)
Dimensions (L x W x H) in, (mm)	21 x 17 x 18 (533 x 432 x 457)

Accessories & Spare Parts		390
Crevice tool 1.25" x 9"	591277701	X
Dusting brush, 1.25" 2000GH46	591210901	X
Filter, motor inlet	591210801	X
Filter, paper bag (5 pk)	591214201	X
Floor tool, ergo slide 1.25"	591211301	X
HEPA filter	591210501	X
Hose assembly, 1.25" x 6'	591211001	X
Tool kit	591220901	X
Uphostery tool, 1.25"	591211401	X
Wand, telescopic 37" x 1.25"	591208301	X

RECOMMENDED EQUIPMENT

GRINDERS | CORE DRILLS | POWER CUTTERS

# Husqvarna Dust Hoods & Bugs

## Dust Hoods for Angle Grinder

### MASONRY & CONCRETE CUTTING

Most commonly used in masonry and concrete industries for tuck pointing to crack chasing. The aerodynamic, ergonomic shape allows full visibility when cutting. Unique and patented design for a maximum particle capture up to 98%.



Dust Hoods			
Sizes - Inches (mm)	Applicable Equipment	Recommended Vac	Part Number
Dust Hood	4-5" Grinders	S 13 or larger	590651801
Dust Hood	7-9" Grinders	S 26 or larger	590651802

Dust Hood Spare Parts			
Sizes - Inches (mm)	5" Dust Hood	7" Dust Hood	Part Number
Brush, hood	X	X	592092501
Cuff, 1.5" hose to hood	X	X	592092601
Cuff, 2" hose to hood	X	X	592248201
Collar, Dewalt D28402	X		591249801
Collar, 5" Dewalt	X		592091401
Collar, 5" Bosch	X		592091501
Collar, 5" Bosch 850	X		592091601
Collar, 5" Makita	X		592091701
Collar, 5" Makita	X		592091801
Collar, 5" Metabo	X		592091901
Collar, 5" Hitachi	X		592092001
Collar, 7" Dewalt		X	592092101
Collar, 7" Bosch		X	592092201
Collar, 7" Makita		X	592092301
Collar, 7" Makita		X	592092401
Collar, 7" Flex		X	591250601
Collar, 7" Hitachi		X	591255001

## Dust Bugs for Core Drills

### CONCRETE CUTTING

Plastic shield can be used with wet applications, replacing the brushes on the hoods.



Dust Bugs			
Sizes - Inches (mm)	Applicable Equipment	Recommended Vac	Part Number
Dust Bug 90	Drilling up to 3 1/4"	S 13 or larger	590652001
Dust Bug 180	Drilling up to 6 3/4"	W 70 P - Wet	590652002

Dust Hood Spare Parts			
Sizes - Inches (mm)	Dust Bug 90	Dust Bug 180	Part Number
Brush	X		591258901
Brush		X	591259101
Brush holder		X	591259301
Clear Ring		X	591259401
Seal Kit		X	591259201
Seal Kit	X		591259001
Cuff, 1.5" hose to hood	X	X	592092601
Cuff, 2" hose to hood	X	X	591248201

# Husqvarna Dust Shrouds & Boots

## Dust Shroud for Hand Grinders

### MASONRY & CONCRETE CUTTING

Deluxe shrouds feature a flip-up section for tight spaces and wall work, a vent hole for airflow adjustment, replaceable wear pads on bottom to extend life and keep suction as well as a swivel vacuum port so hose doesn't kink.



#### Dust Shrouds

Sizes - Inches (mm)	Applicable Equipment	Recommended Vac	Part Number
Deluxe 5" Dust Shroud	5" Grinders	S 13 or larger	593010402
Deluxe 7" Dust Shroud	7" Grinders	S 26 or larger	593010403

#### Dust Shroud Spare Parts

Sizes - Inches (mm)	5" Dust Shroud	7" Dust Shroud	Part Number
Deluxe nylon strips, 5"	X		591257501
Deluxe rubber diaphragm, 5"	X		591259501
Deluxe nylon strips, 7"		X	592687901
Deluxe rubber diaphragm, 7"		X	591259601
Deluxe 7" collar, Bosch		X	593034201
Deluxe 7" collar, Hitachi		X	591252401
Deluxe 7" collar, Makita		X	591252301
Deluxe 7" collar, Metabo		X	591252501
Deluxe 7" collar, Dewalt		X	591252201
Deluxe hose connection, 1.5"	X	X	591265901

## Dust Shroud for Angle Grinders

### PRECAST CONCRETE CUTTING

Dust free chamber/edge grinding on pre-cast concrete panels.



#### Precast Shrouds

Sizes - Inches (mm)	Applicable Equipment	Recommended Vac	Part Number
5" Precast Shroud	5" angle grinder	S 13 or larger	594937221
7" Precast Shroud	7" angle grinder	S 26 or larger	594937322

## Dust Boot for Drills & Hammers

### DRILLING & HAMMERS

Collects dust from drilling and hammers. Flexible tip and swivel hose end enable operators to be close to the work area.



#### Dust Boots

Sizes - Inches (mm)	Applicable Equipment	Recommended Vac	Part Number
Dust Boot	Drills & Hammers	S 13 or larger	590651901

# Dust and Slurry Management Accessories & Spare Parts

Accessories & Spare Parts		T 18000	T 10000	T 8600	T 8600 P	T 7500	T 4000 Petrol	DC 6000
Adapter, 2.5" to 3" hose cuff	590429401						X	
Aluminium camlock (3"), female	590428701	X	X	X	X	X	X	
Bags, dust collection (box of 200)	502570101							X
Bags, Longopac 66 ft (25 m, 6mil)	584650201							X
Blade set, 18" rubber	590428502		X	X	X	X	X	
C5500 Pre-Separator connection kit	590433302			X	X	X		
C5500 Pre-Separator connection kit	590433301		X					
Camlock adaptor (3"-2"), female	590436501	X	X	X	X	X	X	X
Filter, HEPA	590429701	X	X	X	X	X		
Filter, HEPA	590429801						X	
Filter, HEPA 13	579758801							X
Filter sock assembly	590438801			X	X	X		
Filter sock assembly	590438601		X					
Filter sock assembly	590438701	X						
Filter, teflon coated	591947401						X	
Floor tool 2" x 18"	590428302		X	X	X	X	X	
Hose Assembly, 3" Conductive (33')	590437001	X	X	X	X	X		
Hose assembly, 2" x 25'	590428101		X	X	X	X		
Hose assembly 2" x 25'	590437301						X	
Hose assembly 2.5" x 33'	590437401						X	
Hose-to-wand connection (2")	590438101		X	X	X	X	X	
Hosing, vacuum 2" with end fittings (10 m)	585871001							X
Hosing, vacuum 3" with end fittings (10 m)	525584601							X
Longopac, 4pk (72 ft, 6 mil)	590429201	X	X	X	X	X	X	
Pre-filter, conical	590430202						X	
Plug, Male 100A 230V 3Ph	590436401					X		
Plug, Female 100A 230V 3Ph	590436201					X		
Plug, Male 50A 480V 3Ph	590436402		X	X				
Plug, Female 50A 480V 3Ph	590436202		X	X				
Plug, Female 60A 480V 3Ph	590436203	X						
Plug, Male 60A 480V 3Ph	590436403	X						
Silencer, drum	590429601	X						
Soff-Cut® kit, SC3000 tank kit	596236102						X	
Soff-Cut® kit, wide wheel kit	596236801				X		X	
Strap (Husqvarna branded)	584618701							X
Vacuum wand with floor tool	502570301							X
Wand, 2-piece (2")	590829401		X	X	X	X	X	
Y-pipe (4" - 3" - 3")	590429101	X						

Accessories & Spare Parts		S 36	S 36 P	S 26	S 13	S 11	W 70 P	W 70	W 250 P
Accessory kit	598474301					X			
Adapter, 2.5" to 3" hose cuff	592981501			X					
Adapter, inlet valve	594000901	X	X	X					
Blade set, 14" rubber	590428501				X		X	X	X
Blade set, 18" rubber	590428502	X	X	X					
C 3000 Pre-Separator Connection	590433303	X	X						
C 3000 Pre-Separator Connection	590433304			X					
Crevice tool	590428201						X	X	X
Filter bag	592001401					X			
HEPA filter (2)	591924001					X			
Filter, HEPA	590429801	X	X	X	X				
Filter, HPEA	592061401						X	X	X
Filter, polyester	590438901						X	X	X
Filter, teflon coated	591947401	X	X						
Floor tool 1.5" x 14.5"	590428401				X		X	X	X
Floor tool 2" x 18"	590428302	X	X	X					
Floor tool	591992701					X			
Hose assembly 1.5" x 13.5'	590437201				X				
Hose assembly 2" x 25'	590437301	X	X	X					
Hose assembly 2.5" x 33'	590437401	X	X						
Hose kit	590427901						X	X	X



Accessories & Spare Parts		S 36	S 36 P	S 26	S 13	S 11	W 70 P	W 70	W 250 P
Hose-to-wand connection (1.5")	590437501				X		X	X	X
Hose-to-vac connection (1.5")	590428801				X				
Hose-to-wand connection (2")	590438101	X	X	X					
Longopac, upgrade kit	590398501				X				
Longopac, 4pk (72 ft, 6 mil)	590429201	X	X	X	X				
Multi adapter	594956901					X			
Plastic bags (4 gal), 25/pkg	590396102				X				
Pre-filter, conical	590430201			X					
Pre-filter, conical	590430202	X	X						
Pre-filter, conical	590430003				X				
Pump	590469701						X		
S 36 P Soff-Cut® kit, SC3000 tank kit*	596236102		X						
S 36 P Soff-Cut® kit, wide wheel kit*	596236801		X						
Squeegee Kit	591212002			X			X	X	X
Wand, 2-piece (2")	590829401	X	X	X					
Wand, 3-piece (1.5")	590428601				X		X	X	X

Accessories & Spare Parts		C 5500	C 3000	A 2000	A 600
Filter, HEPA	590460801				X
Filter, HEPA	590427701			X	
Hose adaptor, 12"/14"/16"	590437801			X	
Hose adaptor, 8"/10"	590437901				X
Hose assembly, 3" Conductive (33' Long)	590437001	X			
Hose kit, conductive	591970901		X		
Longopac, 4pk (72 ft, 6 mil)	590429201	X	X		
Pre-filter, carbon charcoal	591994101				X
Pre-filter, carbon charcoal	591994001			X	
Pre-filter, 20 pack (12x12x1)	590430001				X
Pre-filter, 20 pack (24x24x1)	590430002			X	
Pre-filter, transportation cover/protection	590480802				X
Pre-filter, transportation cover/protection	590480702			X	

Accessories & Spare Parts		102 Big Red	102	86	45-20P	45-20POV	45
Brush dust, aluminum 3"	592640001	X	X	X	X	X	X
Brush floor, aluminum 1.5" x 14"	592639701	X	X	X	X	X	X
Brush floor tool 1.5" x 14"	591158501	X	X	X	X	X	X
Crevice tool, aluminum	592639601	X	X	X	X	X	X
Crevice tool 1.5" x 17"	591158401		X	X			
Connector, Y-plastic 2 x 1.5 x 1.5	591289301				X	X	X
Dusting brush, 1.5" x 3" round	591158601	X	X	X			
Filter, outer HEPA 14"	591069101			X			
Filter bags, disposable paper (5 pk)	592924001			X			X
Filter bags, disposable paper (5 pk)	592924101		X				
Filter bag, never clog Dacron 1/ea	590954401		X	X			X
HEPA filter, 16"	591218601	X	X				
HEPA filter complete assembly, 14"	591223501			X			
HEPA filter assembly with gasket, 13"	591216101						X
Hose assembly 1.5" x 10'	597935901				X	X	X
Hose, 10' x 1.5" Asy pullman	590947301	X	X	X			
Hose, ends 10' x 1.5"	591216201				X	X	
Metal wand, 5" two-piece	591162901	X	X	X	X	X	
Non-woven bag, 1/ea optional	592948001			X			X
Poly bag, disposable 6 ml 30 x 37-Asbest	591213301		X	X			
Pre-filter	590950501		X				
Pre-filter, HEPA 7.5" x 7.5"	591069001			X			
Pre-filter, polyester 1/ea	590950301		X				
Squeegee floor tool 14"	591160801		X	X	X	X	
Squeegee floor tool, aluminum 1.5" x 14"	592639901	X	X	X	X	X	
Tool kit 45HEPA wet/dry	591219101				X	X	
Tool kit, wet/dry	591219901	X	X	X			
Tool kit, dry	591220201		X	X			
Tool kit, dry	592715401						X
Wet pickup adapter	590946701			X			
Wet pick-up adapter, 16"	591315601	X	X				

# INNOVATIVE SOLUTIONS TO YOUR MOST COMMON CHALLENGES - MASONRY & TILE

Husqvarna masonry saws are developed for efficient and precise cutting of all kinds of bricks and building blocks. Their sturdy, rigid design makes them stable enough to cut large, heavy blocks. The MS 360 G and MS 360, offer new technology not commonly found on masonry saws. Husqvarna masonry saws give you 360 degrees of performance. Introducing the new MS 610 masonry saw that can fit blades up to 24".



## Husqvarna MS 360 Masonry Saw

The MS 360 saw offers precision like no other and has an exceptional cutting depth up to 5" deep for a standard 14" blade. The sturdy and rigid design makes it suitable for large jobs cutting block, brick or pavers. The MS 360 rotates for 22.5 degree and 45 degree bevel cuts and switches easily between plunge and miter cutting which makes it fast and versatile on the job site. The patented water containment system facilitates clean work area.

## Range Overview

The range of Husqvarna masonry saws consists of 4 models with 15 unique variations optimized for cutting bricks and building blocks.



**MS 610 24"**  
Gas & Electric

**MS 610 20"**  
Gas & Electric

**MS 610 14"**  
Electric

**MS 360**  
Electric

**MS 360 Gas**  
Gas

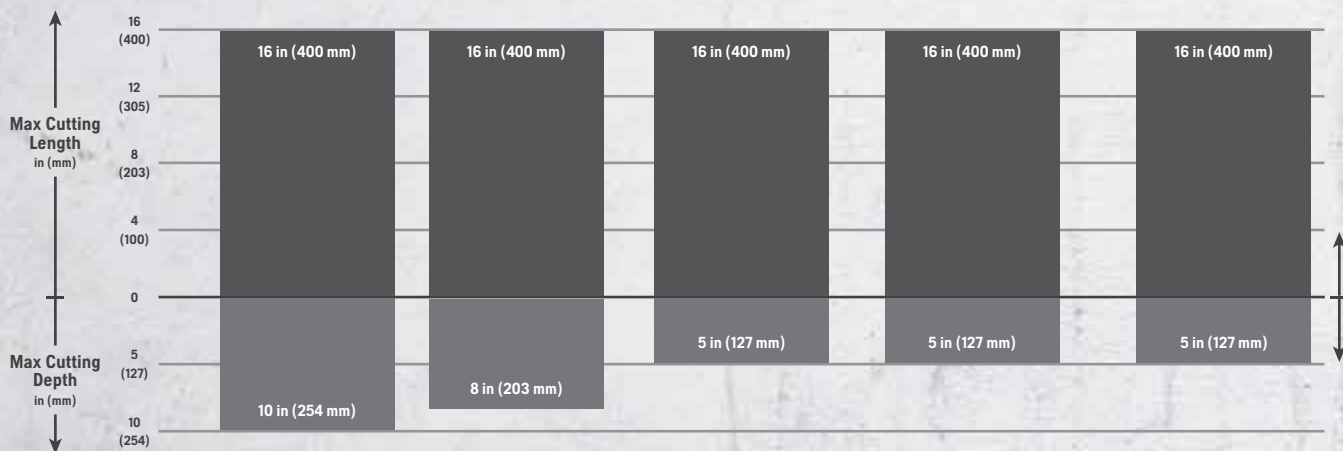





**Easy to Transport** - The optional adjustable stand offers quick and easy set-up and disassemble.

**Clean Work Area** - The patented water containment system enables to adjust and optimize the use of water while cutting. The double water spray splash guard reduces the need for cleaning

**Ergonomic & Low Vibrations** - Integrated telescope carry handles and light weigh facilitates easy movement. Plunge handle ensures low vibrations for the operator.

**High Performance** - Rotates 22.5 degree and 45 degree bevel cuts and can easily switch between plunge and mitre cutting which makes is fast and versitile on the job site.

**MS 360 vac attachment** - The new MS 360 Vac Attachment helps operators adapt to dry cutting and help meet OSHA silica regulations. The dust port on the shroud connects directly to the saw cart of the MS 360 (either electric or gas versions) and can be adjusted for different material sizes.

**On the move** - the optional adjustable vertical/horizontal stand makes it easy to transport the MS 360 and MS 360 G. The saw locks onto the stand making it easy for one person to move around the jobsite. The stand can be easily positions to various heights or easily raised/lower by one person.

# Husqvarna MS 610 Gas

## Applications

- Perfect for large jobs cutting block, brick or pavers.
- Capable of cutting 8" x 8" x 16" block with a 20" blade in one pass or a 10" block with a 24" blade in one pass.

## Benefits

- Available with an 13 hp Kohler gas engine, which provides more power for larger jobs.
- Height can be controlled with a convenient crank control or foot pedal.
- The Sta-level® blade guard keeps the blade guard parallel to the cutting table for accurate cuts.
- Clutch available on 13 hp Kohler model to ensure the blade does not spin while idling.



Masonry Saw Models	MS 610	MS 610	MS 610	MS 610
Masonry Saw Breakdown	Gas 20"	Gas 24"	Gas 20" Clutch	Gas 24" Clutch
Part No. (blade not included)	967673601	967673602	967673603	967673604

## Technical Specifications

Blade diameter, in (mm)	20 (508)	24 (609)	20 (508)	24 (609)
Depth of cut, in (mm)	8 (203)	10 (254)	8 (203)	10 (254)
Bladeshaft, rpm	2,270	2,270	2,270	2,270
Power source	Gasoline	Gasoline	Gasoline	Gasoline
Power, hp (kW)*	13 (9.7)	13 (9.7)	13 (9.7)	13 (9.7)
Engine manufacturer	Kohler	Kohler	Kohler	Kohler
Arbor size, in (mm)	1 (25.4)	1 (25.4)	1 (25.4)	1 (25.4)
Weight uncrated, lbs (kg)	473 (214.5)	473 (214.5)	483 (219)	483 (219)
Weight crated, lbs (kg)	611 (277)	611 (277)	621 (282)	621 (282)
Dimensions uncrated, in (mm) L x W x H	54.5 x 28 x 76 (18 x 9.5 x 25)			

# Husqvarna MS 610 Electric

## Applications

- Perfect for large jobs cutting block, brick or pavers.
- Capable of cutting 8" x 8" x 16" block with a 20" blade in one pass or a 10" block with a 24" blade in one pass.

## Benefits

- High torque, continuous duty dual capacitor motors make efficient use of horsepower and reduce cutting time.
- Height can be controlled with a convenient crank control or foot pedal.
- The Sta-level® blade guard keeps the blade guard parallel to the cutting table for accurate cuts.



Masonry Saw Models	MS 610	MS 610	MS 610	MS 610	MS 610	MS 610
Masonry Saw Breakdown	Electric 14"	Electric 20"	Electric 20"	Electric 20"	Electric 24"	Electric 24"
Part No. (blade not included)	967673503	967673504	967673509	967673512	967673510	967673513

## Technical Specifications

Blade diameter, in (mm)	14 (350)	20 (508)	20 (508)	20 (508)	24 (609)	24 (609)	
Depth of cut, in (mm)	5 (127)	8 (203)	8 (203)	8 (203)	10 (254)	10 (254)	
Bladeshaft, rpm	3,090	3,090	2,317	2,317	2,317	2,317	
Power source	Electric	Electric	Electric	Electric	Electric	Electric	
Power, hp (kW)*	5 (3.7)	5 (3.7)	7.5 (5.6)	7.5 (5.6)	7.5 (5.6)	7.5 (5.6)	
Engine manufacturer	Baldor	Baldor	Baldor	Baldor	Baldor	Baldor	
Arbor size, in (mm)	1 (25.4)	1 (25.4)	1 (25.4)	1 (25.4)	1 (25.4)	1 (25.4)	
Voltage, V	230	230	230	230	230	480	
Cycle/Current	60/AC	60/AC	60/AC	60/AC	60/AC	60/AC	
Phase	1	1	3	3	3	3	
Full load amps	14.5/13	21.5/20	14.5/13	21.5/20	19.4/9.7	19.4/9.7	
Starting amps	188/95	149/139	188/95	149/139	166/83	166/83	
Weight uncrated, lbs (kg)	332 (149)	333 (150)	332 (149)	333 (150)	368 (165)	368 (165)	
Weight crated, lbs (kg)	360 (161)	361 (162)	360 (161)	361 (162)	395 (177)	395 (177)	
Dimensions uncrated, in (mm) L x W x H						47.75 x 22 x 57.5 (1,213 x 559 x 1,461)	



# Husqvarna MS 360

## Applications

- Perfect for large jobs cutting block, brick or pavers.
- Cuts up to 5" deep.

## Benefits

- Equipped with a patented water management system that keeps the work piece dry and the workplace clean.
- The double splash guard decreases water spray behind the saw and makes cleaning easier.
- Head rotates to easily cut 22.5 degree and 45 degree bevel cuts.
- It is easy for two people to move the saw thanks to integrated telescopic handles.
- Sta-level® blade guard keeps the blade guard parallel to the cutting table for accurate cuts.



Masonry Saw Models	MS 360	MS 360	MS 360	MS 360
Masonry Saw Breakdown	115V 1.5HP	115V/230V 1.5HP	115V/230V 2HP	230V 3HP
Part No. (adjustable stand sold separately)	967285201	967285202	967285203	967285204

## Technical Specifications

Blade diameter, in (mm)	14 (350)	14 (350)	14 (350)	14 (350)
Depth of cut, in (mm)	5 (127)	5 (127)	5 (127)	5 (127)
Bladeshft, rpm	2,330	2,330	2,330	2,330
Power source	Electric	Electric	Electric	Electric
Power, hp (kW)*	1.5 (1.1)	1.5 (1.1)	2 (1.5)	3 (2.2)
Arbor size, in (mm)	1 (25.4)	1 (25.4)	1 (25.4)	1 (25.4)
Voltage, V	115	115/208-230	115/208-230	208-230
Plug Type	L5-15	L5-15	L6-20	L6-20
Cycle/Current	60/AC	60/AC	60/AC	60/AC
Phase	1	1	1	1
Full load amps	14	14/7	18/9	12.5
Weight uncrated, lbs (kg)	131 (59.5)	131 (59.5)	139 (63)	147 (67)
Weight crated, lbs (kg)	171 (77)	171 (77)	182 (82)	191 (86)
Dimensions uncrated, in (mm) L x W x H				39.8 x 26.4 x 25.6 (1010 x 670 x 650)

# Husqvarna MS 360 G

## Applications

- Perfect for large jobs cutting block, brick or pavers.
- Cuts up to 15" deep.

## Benefits

- Spring-assisted head enables easy plunge cutting.
- Sta-level® blade guard keeps the blade guard parallel to the cutting table for accurate cuts.
- Low vibration design facilitates a smoother cut and increases the machine's longevity.
- It is easy for two people to move the saw thanks to integrated telescopic handles.



<b>Masonry Saw Models</b>	<b>MS 360</b>
<b>Masonry Saw Breakdown</b>	<b>Gas</b>
Part No. (adjustable stand sold separately)	967318201

## Technical Specifications

Blade diameter, in (mm)	14 (350)
Depth of cut, in (mm)	5 (127)
Bladeshaft, rpm	3,100
Power source	Gasoline
Power, hp (kW)*	4.8 (3.6)
Engine manufacturer	Honda
Arbor size, in (mm)	1 (25.4)
Weight uncrated, lbs (kg)	169.75 (77)
Weight crated, lbs (kg)	234 (106)
Dimensions uncrated, in (mm) L x W x H	44 x 16 x 37 (1,120 x 639 x 938)

# Masonry Stands & Attachments

## Applications

- Adjustable stand can be positioned, with one hand, at various heights for operator comfort or collapsed.
- Fixed height stand allows for easy set up and transportation due to integrated transport wheels.



Masonry Stand Models	Adjustable Stand	Fixed Height Stand
Part No.	590296801	579596401



## MS 360 Vac Attachment

The new MS 360 Vac Attachment helps operators adapt to dry cutting and help meet OSHA silica regulations. The dust port on the shroud connects directly to the saw cart of the MS 360 (either electric or gas versions) and can be adjusted for different material sizes.



Masonry Attachments	Vac Attachment
Part No.	589909901

Wet Cutting Masonry	W-Line	Water Supply	Dry Masonry Sawing	S 26
MS 360	+	Water pump ✓	MS 360	VK ✓
MS 360 G	+	Water pump ✓	MS 360 G	VK ✓

✓ Attached to machine + Part of solution **VK** - Vac Kit

TO LEARN MORE ABOUT HOW OUR PRODUCTS CAN HELP MEET OR EXCEED OSHA SILICA REGULATIONS, PLEASE VISIT [WWW.HUSQVARNACP.COM/US/SILICA](http://WWW.HUSQVARNACP.COM/US/SILICA)

## Masonry Saw Accessories & Spare Parts

Accessories		MS 610 E	MS 610 G	MS 360	MS 360 G
Adapter cord, 20A twist to 15A straight	542173120			X	
Rip Guide	542030351	X	X		
Stand, adjustable rolling	585581601			X	X
Stand, fixed leg	579596401			X	X
Wheel-Around Kit	501539201	X	X		
Wheel kit, conveyor cart replacement	542189041	X	X		
Spare Parts		MS 610 E	MS 610 G	MS 360	MS 360 G
Belt	581299901				X
Blade guard seal	585246301			X	
Conveyer cart complete	581342501			X	
Conveyor cart	584875701	X	X		
Drive belt	581559101			X	
Filter, pump	585520901				X
Water pan drain plug kit	583951701			X	
Water pump, electric	542032088	X	X		
Water pump/Water Pump, 110V TS70/TS90	586668301			X	
Wrench, blade shaft	510225437			X	

# Diamond Blades for Masonry Sawing



MATERIAL	ELITE-CUT REFRACTORY	ELITE-CUT TURBO	ELITE-CUT TURBO (S)	ELITE-CUT BRICK	ELITE-CUT BRICK (S)
REFRACTORY	● ● ●	-	-	-	-
NATURAL STONE	-	● ●	● ●	● ●	● ●
HARD BRICK	-	● ● ●	● ● ●	● ● ●	● ● ●
GENERAL PURPOSE (BRICK, BLOCK, PAVERS)	-	●	●	● ●	● ●
LOW DENSITY BRICK AND BLOCK	-	-	-	-	-

MATERIAL	ELITE-CUT GP	ELITE-CUT GP (S)	ELITE-CUT BLOCK	ELITE-CUT Block (S)
REFRACTORY	-	-	-	-
NATURAL STONE	●	●	-	-
HARD BRICK	●	●	-	-
GENERAL PURPOSE (BRICK, BLOCK, PAVERS)	● ● ●	● ● ●	● ●	● ●
LOW DENSITY BRICK AND BLOCK	● ●	● ●	● ● ●	● ● ●

MATERIAL	VARI-CUT TURBO	VARI-CUT	VARI-CUT MASONRY	TACTI-CUT VH3	TACTI-CUT VH5
REFRACTORY	-	-	-	-	-
NATURAL STONE	● ●	-	-	●	-
HARD BRICK	● ● ●	● ●	-	●	● ●
GENERAL PURPOSE (BRICK, BLOCK, PAVERS)	●	● ● ●	● ●	● ● ●	● ● ●
LOW DENSITY BRICK AND BLOCK	-	●	● ● ●	●	● ●

●●●= Optimal ●●= Good ●= Acceptable - = Not recommended

GOLD	SILVER	BRONZE
------	--------	--------



# Small Diameter Diamond Blades



MATERIAL	CONTINUOUS RIM			
	ELITE-CUT PORCELAIN+	ELITE-CUT GLASS+	VARI-CUT™ TILE	TACTI-CUT C DRI DISC®
GLASS	-	● ● ●	-	-
PORCELAIN TILE	● ● ●	●	● ●	● ●
DENSE FLOOR TILE	● ● ●	●	● ●	● ● ●
SOFT CERAMIC TILE	● ● ●	●	● ● ●	● ● ●
MARBLE	● ● ●	● ●	● ●	● ●
GRANITE	● ● ●	● ●	● ●	● ●
BLUE STONE	● ● ●	● ●	● ●	● ●
SLATE	● ● ●	-	● ● ●	● ● ●

MATERIAL	SEGMENTED			TURBO	
	VARI-CUT™	TACTI-CUT S DRI DISC®	FR3 DISC	VARI-CUT™ TURBO	TACTI-CUT T DRI DISC®
GLASS	-	-	-	-	-
PORCELAIN TILE	-	-	-	●	●
DENSE FLOOR TILE	-	-	-	●	●
SOFT CERAMIC TILE	-	-	-	●	●
MARBLE	●	●	-	● ● ●	● ● ●
GRANITE	● ●	● ●	-	● ● ●	● ● ●
BLUE STONE	● ●	● ●	-	● ● ●	● ● ●
SLATE	● ●	● ●	-	● ● ●	● ● ●
PAVERS	● ● ●	● ● ●	-	● ●	● ●
ROOFING TILE	● ● ●	● ● ●	●	● ● ●	● ● ●
BRICK	● ● ●	● ● ●	●	● ● ●	● ● ●
ABRASIVE MATERIALS	●	● ●	●	● ●	●
PVC	-	-	●	-	-
REBAR/DUCTILE IRON	-	-	● ● ●	-	-

●●●= Optimal ●●= Good ●= Acceptable - = Not recommended

GOLD	SILVER	BRONZE
------	--------	--------

# Diamond Blades for Masonry Sawing

## Elite-Cut/Elite-Cut (S) Masonry Series NONSILENT CORE & SILENT CORE MASONRY

- Elite-Cut Turbo/Turbo(S): thick granite, marble/similar stone and high density masonry brick.  
Free cutting on extremely hard, dense and non-abrasive materials.
- Elite-Cut Brick/Brick(S): brick pavers, dense concrete pavers and general purpose brick.
- Elite-Cut GP/GP(S): general purpose masonry applications including brick, pavers/patio block and other low density masonry brick.
- Elite-Cut Block/Block(S): Abrasive, lightweight block. Longer life in block and low density brick.



### Elite-Cut Series | Dry or Wet Cutting | Laser Welded

Sizes - Inches (mm)	Turbo Series Part No.	Brick Series Part No.	GP Series Part No.	Block Series Part No.
14 (350) x .125x 1 DP	589518001	589518201	589518401	589518601
20 (508) x .140 x 1 DP	589518101	589518301	589518501	589518701
24 (609) x .140 x 1 DP	-	-	-	590907701

Total segment height is .500" (.400" diamond depth, .100" segment base).

### Elite-Cut Series (Silent Core) | Dry or Wet Cutting | Laser Welded

Sizes - Inches (mm)	Turbo Series Part No.	Brick Series Part No.	GP Series Part No.	Block Series Part No.
14 (350) x .125x 1 DP	589517201	589517401	589517601	589517801
20 (508) x .140 x 1 DP	589517301	589517501	589517701	589517901
24 (609) x .140 x 1 DP	-	-	-	591144601

Total segment height is .500" (.400" diamond depth, .100" segment base).

## Elite-Cut Refractory REFRACTORY MASONRY

- Elite Cut Refractory: Fast cutting in hard, 80-90% high alumina, super-duty blast furnace materials including dense castable refractories of alumina, calcia, silica, zirconia, magnesia and a wide range of difficult-to-cut refractories.



### Refractory | Dry or Wet Cutting | Laser Welded

Sizes - Inches (mm)	Part Number
14 (350) x .110 x 1 DP	590043501
18 (450) x .125 x 1 DP	590043601
20 (508) x .125 x 1 DP	590043901

Total segment height is .335" (.260" diamond depth, .75" segment base).

# Diamond Blades for Masonry Sawing

## Vari-Cut™ Series

GENERAL PURPOSE, ABRASIVE MATERIAL

- Vari-Cut™: general purpose, cured concrete, brick.
- Vari-Cut™ Turbo: fast cutting, hard concrete, stone and masonry materials.
- Vari-Cut Masonry: masonry blade design for fast cutting and long life in construction blocks

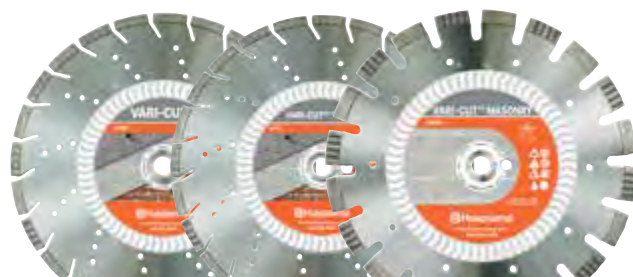

**Vari-Cut Series | Dry or Wet Cutting | Laser Welded**

Sizes - Inches (mm)	Vari-Cut Part Number	Vari-Cut Turbo Part Number	Vari-Cut Masonry Part Number
14 (350) x .110 x 1 DP	542751359	586107801	587620001
20 (508) x .125 x 1 DP	-	-	587620002

Total segment height Vari-Cut & Vari-Cut Turbo: .400" (.300" diamond depth). Total segment height for Vari-Cut Masonry: .335" (.260" diamond depth, .075" segment base).

## Tacti-Cut™ VH Series

GENERAL PURPOSE MATERIAL

- Tacti-Cut VH3: continuous rim for fast, clean cuts in concrete, brick and natural stone.
- Tacti-Cut VH5: general purpose, brick and masonry.



**Tacti-Cut Series | Dry or Wet Cutting | Laser Welded**

Sizes - Inches (mm)	Tacti-Cut VH3 Part Number	Tacti-Cut VH5 Part Number
14 (350) x .118 x 1 DP	-	542774463
14 (350) x .125 x 1 DP	589487901	-

Total segment height is .450" (.350" diamond depth).

MASONRY SAWS

# Small Diameter Diamond Blades

## Elite-Cut Series HIGH PRODUCTION BLADES

- Elite-Cut Porcelain+: fast, smooth, chip-free cuts on porcelain tile, granite, other stone materials.
- Elite-Cut Glass+: fast, chip-free cutting glass tile.

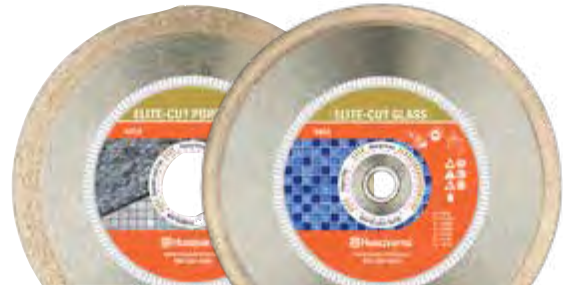

### Elite-Cut Series | Wet Cutting | Continuous Rim

Sizes - Inches (mm)	Elite-Cut Porcelain Part No.	Elite-Cut Glass Part No.
6 (152) x .060 x 5/8	542761271	542776615
7 (178) x .060 x 5/8	542761272	542776616
8 (203) x .060 x 5/8	542761273	542776617
8 (203) x .060 x 1	542761275	-
10 (254) x .060 x 5/8	542761276	542776618
10 (254) x .070 x 5/8	542761277	-
10 (254) x .060 x 1	542761278	-
10 (254) x .060 x 5/8 (10 pk)	-	587967901

Total segment height for Porcelain .375". Total segment height for Glass .275".

## Vari-Cut™ GENERAL PURPOSE BLADES

- Vari-Cut: fast cutting in general purpose brick, concrete & masonry applications. Perfect combination, small diameter blade.



### Vari-Cut | Dry or Wet Cutting | Segmented

Sizes - Inches (mm)	Part Number
4 (100) x .085 x 7/8	501510401
4.5 (114) x .085 x 7/8	501510402
5 (127) x .085 x 7/8	501510403
6 (152) x .085 x DM	501510405
7 (178) x .090 x DM - 7/8 - 5/8 B	501510404
10 (254) x .095 x 7/8	588563104

Total segment height for Vari-Cut .275".

SMALL DIAMETER  
BLADES

## Small Diameter Diamond Blades

### Vari-Cut™ Turbo

#### GENERAL PURPOSE BLADES

- Vari-Cut Turbo: smooth cutting in brick, concrete & various stone material.
- Vari-Cut Turbo: Flush cut pattern 4", 4.5", 5", 6" and 7".



#### Vari-Cut Turbo | Dry or Wet Cutting | Segmented

Sizes - Inches (mm)	Part Number
4 (100) x .085 x DM - 7/8 - 5/8 B	579827701
4.5 (114) x .085 x DM - 7/8 - 5/8 B	579827801
5 (127) x .085 x DM - 7/8 - 5/8 B	579827901
6 (152) x .085 x DM - 7/8 - 5/8 B	579828001
7 (178) x .085 x DM - 7/8 - 5/8 B	579828101
8 (203) x .095 x DM - 7/8 - 5/8 B	579828201
9 (230) x .100 x 7/8 - 5/8 B	579828301
10 (254) x .100 x 7/8 - 5/8 B	579828401

Total segment height for Vari-Cut .400".

### Vari-Cut™ Tile

#### GENERAL PURPOSE BLADES

- Vari-Cut Tile: chip-free cutting porcelain tile, granite and dense floor tile with a thin rim.



#### Vari-Cut Tile | Wet Cutting | Continuous Rim

Sizes - Inches (mm)	Part Number
4 (100) x .060	542761281
4.5 (114) x .060	542761458
7 (178) x .060	542761282
8 (203) x .060	542761283
10 (254) x .070	542761284
10 (254) x .070 (10 pk)	587967601

Total segment height for Vari-Cut .275".



# Small Diameter Diamond Blades

## Tacti-Cut Series Dri Disc® HARD MATERIAL BLADES



- Tacti-Cut S: affordable, fast cutting concrete, masonry, brick & stone.

### Tacti-Cut S | Dry or Wet Cutting | Diffusion Bonded

Sizes - Inches (mm)	Part Number
4 (100) x .065 x 7/8 - 20mm - 5/8 B	542761408
4.5 (114) x .065 x 7/8 - 20mm - 5/8 B	542761409
5 (127) x .065 x 7/8 - 20mm - 5/8 B	542761410
6 (152) x .080 x DM 7/8 - 5/8 B	542761411
7 (178) x .095 x DM - 7/8 - 5/8 B	542761412
8 (203) x .095 x DM - 7/8 - 5/8 B	542761413
9 (230) x .100 x 7/8 - 5/8 B	542761414
10 (254) x .100 x 7/8 - 5/8 B	542761415

Total segment height for Tacti-Cut S .275".

## Tacti-Cut C Dri Disc® TILE & STONE BLADES



- Tacti-Cut C: economical blade, dry cutting most ceramic tile, quarry tile, porcelain, tile, granite, marble, similar materials.
- Recommended for grout cleaning between lines.

### Tacti-Cut C | Dry or Wet Cutting | Continuous Rim

Sizes - Inches (mm)	Part Number
4 (100) x .060 x 7/8 - 20mm - 5/8 B	542761257
4.5 (114) x .060 x 7/8 - 20mm - 5/8 B	542761258
5 (127) x .060 x 7/8 - 20mm - 5/8 B	542761259
7 (178) x .060 x 5/8	542761261
8 (203) x .060 x 5/8	542761262
10 (254) x .060 x 5/8	542761264

Total segment height for Vari-Cut .200".

## Small Diameter Diamond Blades

### Tacti-Cut T Dri Disc®

#### GENERAL PURPOSE BLADES

- Vari-Cut T: fast cutting in general purpose brick, concrete & masonry applications. Perfect combination, small diameter blade.



#### Tacti-Cut T | Dry or Wet Cutting | Continuous Rim

Sizes - Inches (mm)	Part Number
4 (100) x .080 x 7/8 - 20 mm - 5/8 B	542761416
4.5 (114) x .080 x 7/8 - 20 mm - 5/8 B	542761417
5 (127) x .080 x 7/8 - 20 mm - 5/8 B	542761418
6 (152) x .080 x DM - 7/8 - 20 mm - 5/8 B	542761419
7 (178) x .095 x DM - 7/8 - 5/8 B	542761420
8 (203) x .095 x DM - 7/8 - 5/8 B	542761421
9 (230) x .100 x 7/8	542761422
10 (254) x .110 x DM - 7/8 - 5/8 B	542761423

Total segment height for Vari-Cut .275".

### FR3 Dri Disc®

#### METAL CUTTING BLADES

- FR3: free cutting hard materials. PVC, tile backer boards, steel and roofing tiles.



#### FR3 | Dry or Wet Cutting | Brazed Diamonds

Sizes - Inches (mm)	Part Number
4 (100) x .080 x 7/8 - 5/8 B	542773402
4.5 (114) x .080 x 7/8 - 5/8 B	542773403
6 (152) x .090 x DM 7/8 - 5/8 B	542766306
6 (152) x .090 x 1DP - 20mm B	542766346
7 (178) x .095 x DM - 7/8 - 5/8 B	542773404
10 (254) x .095 x DM - 7/8 - 5/8 B	542767276

Total segment height for Vari-Cut .275".

# Small Diameter Diamond Blades

## FLX Trio

### GENERAL PURPOSE BLADES

- FLX Trio: DIY projects, cuts tile, bricks, blocks and stone.
- Includes three blades.



#### FLX Trio | Dry or Wet Cutting | Diffusion Bonded

##### Sizes - Inches (mm)

4.5 (114) x .080 x 7/8 - 20mm - 5/8 B

Total segment height for FLX Trio .200".

##### Part Number

**585740301**

## Gold Crack Chasing Blade

### GENERAL PURPOSE BLADES

- Gold Crack Chasing: cleans, routs, repairs cracks in concrete and other materials.
- V-shape turbo rim with 5/8" - 11 threads.



#### Gold Crack Chasing Blade | Dry or Wet Cutting | Diffusion Bonded

##### Sizes - Inches (mm)

4 (100) x .375 x 5/8 - 11

4.5 (114) x .375 x 5/8 - 11

Total segment height: .320" (.250" diamond depth, .070" segment base).

##### Part Number

**542776133**

**542751357**

## Profile Wheels

### MARBLE & GRANITE

- Profile Wheels: commercial/residential applications, natural stones, most synthetic materials.
- Decorative edging jobs in four popular shapes: 3/8" radius, 45° bevel, and ogee.



#### Profile Wheels | Wet Cutting

##### Sizes - Inches (mm)

##### Spec.

##### Part Number

6 (152) x 5/8 arbor

3/8" radius

**542761302**

6 (152) x 5/8 arbor

1/2" radius

**542761303**

6 (152) x 5/8 arbor

45° bevel

**542761304**

6 (152) x 5/8 arbor

Ogee

**542761305**

8 (201) x 5/8 arbor\*

3/8" radius

**542751613**

8 (201) x 5/8 arbor\*

1/2" radius

**542751614**

\*TS 60 saw requires an 8 inch profile wheel.

## Small Diameter Diamond Blades

### Tuckpoint Series Blades

#### GENERAL PURPOSE BLADES

- DT5+: soft bond, quickly remove mortar between brick and block.
- DT8+: hard bond, longer life removing mortar between brick and block.
- DTR5: double row of tuckpointing for aggressive mortar removal.

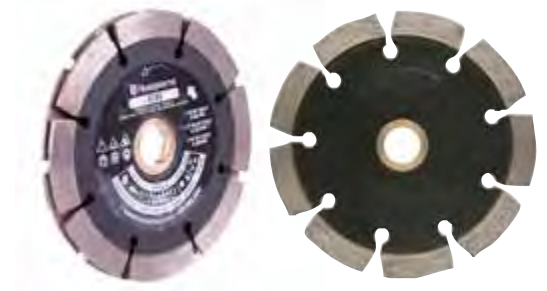

#### Tuckpointing Series Blades | Dry or Wet Cutting | Laser Welded

Sizes - Inches (mm)	DT5+ Part Number	DT8+ Part Number
4 (100) x .250 x 7/8 - 5/8 B	542774592	542774622
4.5 (114) x .250 x 7/8 - 5/8 B	542774593	542774623
5 (127) x .250 x 7/8 - 5/8 B	542774594	542774624
7 (178) x .250 x DM - 7/8 - 5/8	542774595	542774625

Total segment height: .400".

#### Tuckpointing Series Blades | Dry or Wet Cutting | Diffusion Bond

Sizes - Inches (mm)	DTR5 Part Number
4 (100) x .250 x 7/8 - 5/8 B	542774613
4.5 (114) x .250 x 7/8 - 5/8 B	542774614
5 (127) x .250 x 7/8 - 5/8 B	542774615
7 (178) x .250 x DM - 7/8 - 5/8	542774616

Total segment height: .400".

### Bevel Tuckpoint

#### GENERAL PURPOSE BLADES

- 45° Bevel Tuckpoint: crack chasing and mortar removal between brick and block.
- Multi-purpose blade for the restoration market. V-shaped segments leave a clean groove for easy filling and repair.



#### Bevel Tuckpoint | Dry or Wet Cutting | Laser Welded

Sizes - Inches (mm)	Part Number
4 (100) x .375 x 7/8 x 5/8 B	542751353
4 (100) x .375 x 5/8 - 11	587901801
7 (178) x .375 x 7/8 - 5/8 B	542751354

Total segment height: .525" (.325" diamond height, .200" segment base)

# Small Diameter Diamond Blades

## Vari-Cut™ Cup Wheels

CONCRETE, MASONRY, STONE

- Vari-Cut™ Cup Wheels: combination tool, fast removal, concrete, masonry and stone materials.
- Total segment height is .200" diamond segment.
- 30 grit size only.



### Vari-Cut Cup Wheels | Dry or Wet Cutting | Brazed

Sizes - Inches (mm)	Part Number
4 (100) x 5/8 - 11 THD (Turbo)	542751660
4.5 (114) x 5/8 - 11 THD (Turbo)	542751661
5 (127) x 5/8 - 11 THD (Turbo)	542751662
7 (178) x 5/8 - 11 THD (Turbo)	542751663

## Cup Wheels

CONCRETE, MASONRY, STONE

- Single Rim: fast removal on concrete, masonry, stone & similar materials.
- Double Rim: long life and smooth finish on concrete, masonry, stone & similar materials.
- Turbo Rim: faster and smoother finish on concrete, masonry, stone & similar materials.



### Cup Wheels | Dry or Wet Cutting | Brazed

Sizes - Inches (mm)	Segments	Single Rim Part No.	Segments	Double Rim Part No.	Segments	Turbo Rim Part No.
4 (100) x 5/8 - 11 THD	8	542751303	16	585327108	13	585327111
4 (100) x 7/8 - 5/8 B	8	542751306	16	542751307	13	542751308
5 (127) x 5/8 - 11 THD	11	585327106	20	585327109	14	585327112
5 (127) x 7/8 - 5/8 B	11	542751312	20	542751313	-	-
7 (178) x 5/8 - 11 THD	12	585327107	27	585327110	24	585327113
7 (178) x 7/8 - 5/8 B	12	542751317	27	542751318	24	542751319

### Cup Wheels | Dry or Wet Cutting | Brazed

Sizes - Inches (mm)	Segments	Single Rim Part No.	Segments	Double Rim Part No.	Segments	Turbo Rim Part No.
4 (100) x 5/8 - 11 THD	8	585327117	16	585327119	10	585327121
4 (100) x 7/8 - 5/8 B	8	542773076	16	542773077	10	542773078
7 (178) x 5/8 - 11 THD	12	585327118	24	585327120	18	585327122
7 (178) x 7/8 - 5/8 B	12	542773079	24	542773080	18	542773081

SMALL DIAMETER  
BLADES



## Small Diameter Diamond Blade Accessories

### Accessories



#### Flush Mount Adapter

Sizes - Inches (mm)

5/8" - 11

Part Number

542420404

#### Threaded Adapter

Sizes - Inches (mm)

7/8" x 5/8" - 11

Part Number

542751356

#### Bushing

Sizes - Inches (mm)

2.4 (60) x 1" x .087"

2 (50) x 1" x .087"

Part Number

542380205

542380209

# HIGH PERFORMANCE ROBOTS FOR SAFE & EFFICIENT DEMOLITION

Our remote-controlled demolition robots are the very latest in demolition machines, featuring high power, low weight and functional design. They are the obvious choice for users who want maneuverable yet highly powerful, stable machines with a long reach. Our DXR machines have a modern and easy-to-use remote control, with unrivaled user-friendliness and design. All this, combined with our experience, know-how and global presence, means you are also assured of highly accessible and competent service and support.



## The Husqvarna DXR User Guide

The comprehensive Husqvarna DXR user guide is a digital complement to the operator's manual. Here you'll find 35 short videos explaining everything from transportation and planning to maintenance and machine care. Safety and ergonomics have always been key areas in our product development, since it automatically leads to more efficient work. This digital guide is a useful source of information for both full-time users and those who use demolition robots less frequently. [Click here to view the DXR User Guide.](#)

## Range Overview

The range of Husqvarna demolition robots consists of four base models, from the 20 hp DXR 140 with 360°+ rotating arm to the 30 hp DXR 310 with telescopic arm. Weights range from 2,132 to 4,453 lbs.. With the feature packages, the DXR range is available in 17 different variants. For maximum productivity, choose the optimal configuration for your kind of operation.

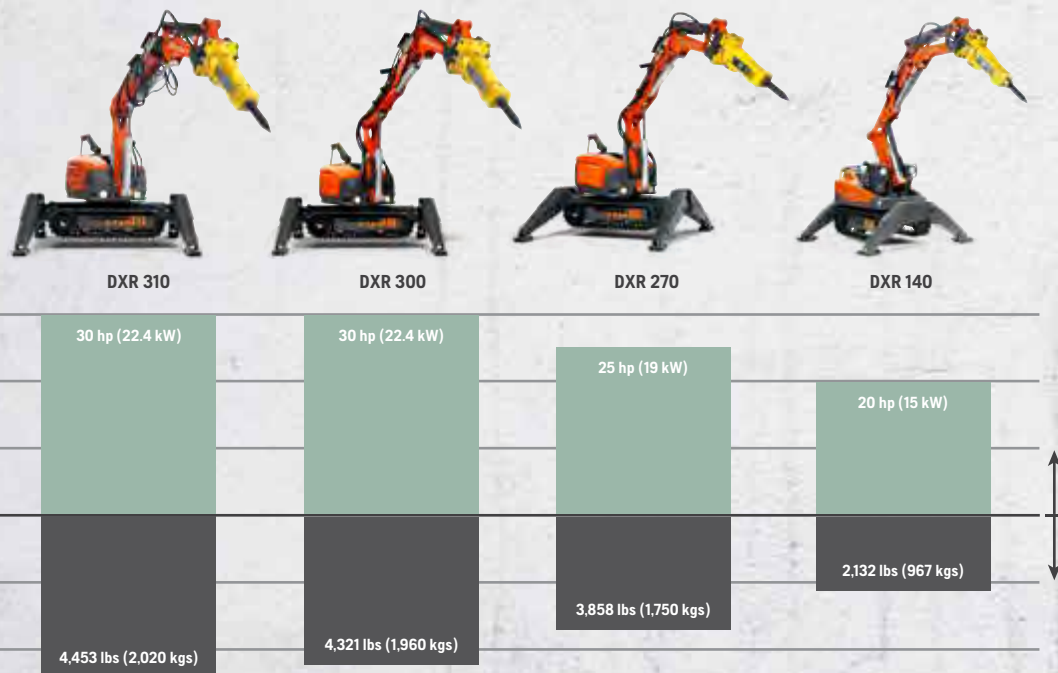





**Agile** - Husqvarna DXR 140 demolition robot has one particularly smart feature: its arm can rotate 360 degrees. This has an excellent reach, so you can work more efficiently without moving the robot once it's securely positioned on its outriggers.

**Compact** - The narrow width allows the machines to pass through standard door openings. The low height enables you to see over the machine when you work, making operation more efficient and safer as well as lowering the machine's center of gravity. The outriggers have an extra wide span for superior stability and high workload.

**Productive** - The machines are developed entirely by Husqvarna and have a high power-to-weight ratio. They are easy-to-operate due to smart functional design, innovative engineering and their technology. They move quickly into position and are ready to start work without time-consuming preparation.

**Wireless remote control** - The market's most modern and easy-to-use, featuring redesigned joysticks to increase responsiveness and ultimately precision. It controls everything the machine does, simply and conveniently. The 3.5-inch color display is easy to read and uses industrial Bluetooth technology.



# FACTORY-INSTALLED FEATURE OPTIONS FOR ADDED PRODUCTIVITY

You can order your Husqvarna DXR to be delivered with additional features for increased precision, performance and protection. Installing these options in our clean factory environment saves time and money and maximizes the quality of the installation.



## ENHANCED COOLING

Allows the DXR to work continuously with full power in higher ambient temperatures, enabling higher productivity in various applications such as cement kilns and steel mills. Available for all DXR models except DXR 140.



## HYDRAULIC OPTION

Allows the operator to precisely control one extra hydraulic function, such as axial rotation of grapples and shearer. Protection shields for the outer hydraulic cylinders are also included. Standard on all DXR models starting in 2017.

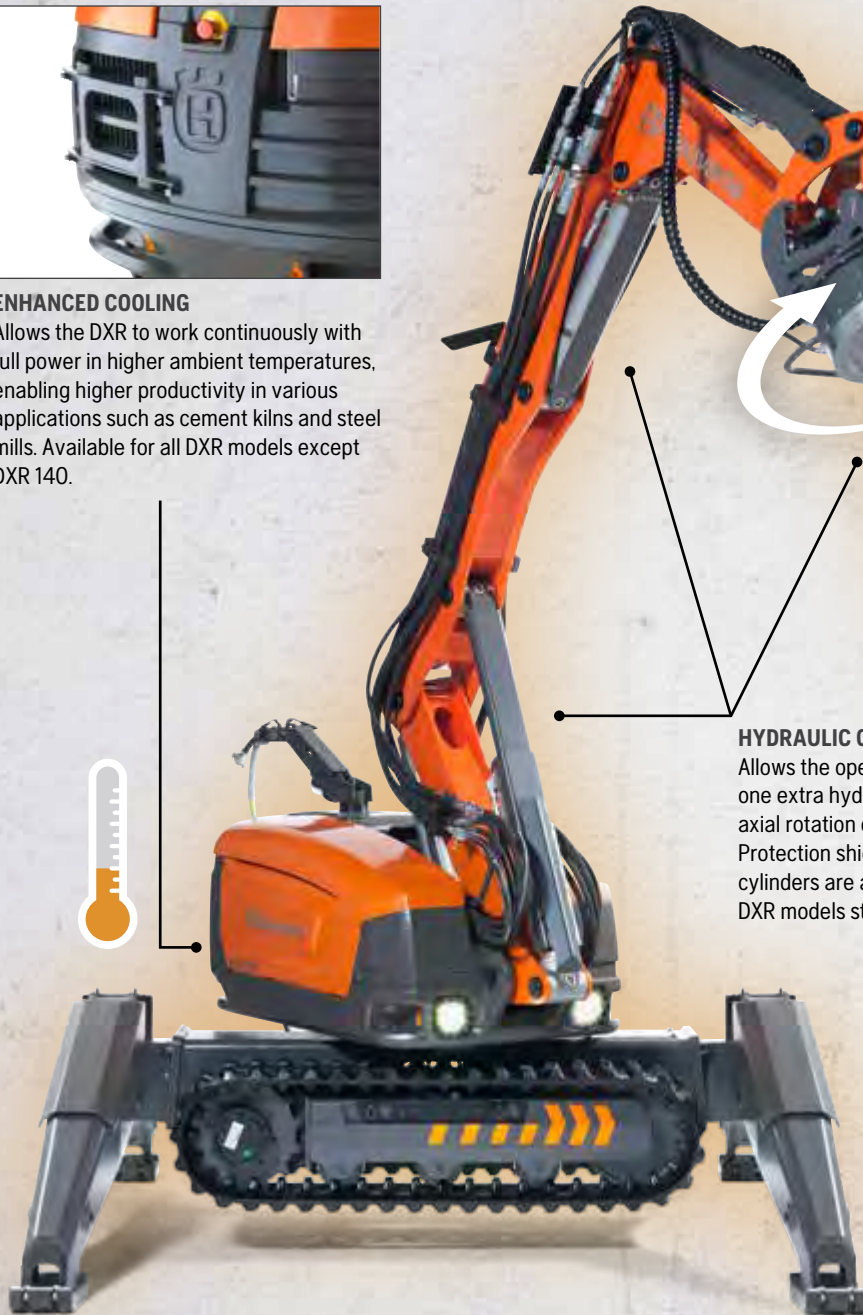

DXR BENEFITS	Extra Function Hydraulic Kit	Cylinder Protection (C2+C3)	Cooling Package	Hose Protection	Fire Resistant Hydraulic Oil	Steel Tracks	Steel Feet	Cooling Extension Kit for Hammer	Heat Protection Kit for SB202/302
<b>HYDRAULIC OPTIONS</b> (standard on all models since 2017)	✓	✓							
<b>ENHANCED COOLING OPTION</b>			✓						
<b>HEAT PROTECTION OPTIONS</b>				✓		✓	✓	✓	✓
<b>HEAT PROTECTION PACKAGE</b>	✓	✓	✓	✓	✓	✓	✓	✓	

**HEAT PROTECTION**

Allows the DXR to be used for de-slugging in hot melting plants and similar applications. Protects vital parts from damage caused by radiant heat as well as conduction heat. Available for DXR 270, DXR 300 and DXR 310.





# READY FOR ANY CHALLENGE.

## SENSITIVE AREAS

The electric motor doesn't produce exhaust, the low weight and compact size mean the DXR is ideal for dismantling work indoors and in areas such as hospitals, hotels or laboratories.

## PRECISE DEMOLITION

A DXR is the ideal machine for demolition of partial structures, such as pipes, staircases and ceilings, where high precision is needed to avoid damaging the remaining structures.

REMOTE  
DEMOLITION



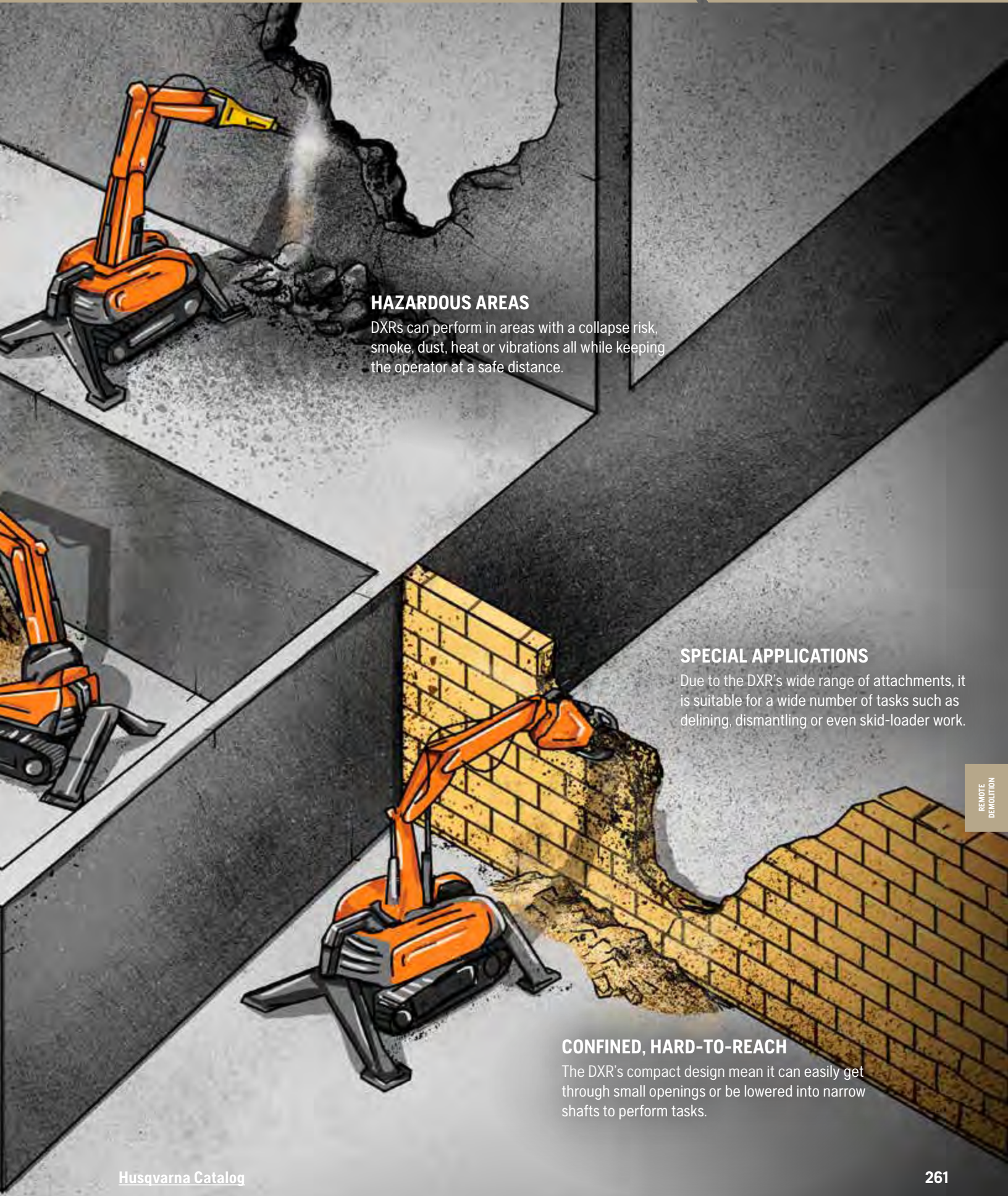

**HAZARDOUS AREAS**

DXRs can perform in areas with a collapse risk, smoke, dust, heat or vibrations all while keeping the operator at a safe distance.

**SPECIAL APPLICATIONS**

Due to the DXR's wide range of attachments, it is suitable for a wide number of tasks such as delimiting, dismantling or even skid-loader work.

**CONFINED, HARD-TO-REACH**

The DXR's compact design mean it can easily get through small openings or be lowered into narrow shafts to perform tasks.

REMOTE  
DEMOLITION

# Husqvarna DXR 310

## Applications

- Efficient in tough, dusty environments such as steel processing plants.
- Ideal for demolition of concrete and brick constructions, staircases, roofs and balconies.

## Benefits

- Long telescopic arm (18 ft) of high-quality steel and stepless slow-motion operation deliver maximum precision.
- Low height allows the user to see over the machine during operation and a low center of gravity increases stability.
- Operator can adjust the flow and pressure of the tool attachment to run other hydraulic equipment.
- Zero exhaust emissions. 100% electric over hydraulic operation.
- Includes two hydraulic outlets at the tool hitch for attachments.



DXR Model	DXR 310
Part No. (breaker not included)	965995313
Part No. (breaker not included, includes extreme heat package)	965995308 (special order)

## Technical Specifications

Power, hp (kW)	30 (22)
Voltage, V	480
Rated current, amps	38.5
Power supply	3-phase
Weight, lbs (kg)	4,453 (2,020)
Reach*, ft (m)	18 (5.5)
Flow 60 Hz, g/min (l/min)	17 (65)
System pressure, nominal maximum, psi (bar)	2,901 (200)
System pressure, increased maximum, psi (bar)	3,626 (250)
Variable flow to tools and system, g/min (L/min)	0-17 (0-65)
Pump type	Variable load-sensing axial piston pump
Width, machine body, in (mm)	31 (780)
Length, machine body, including outriggers, in (mm)	81 (2,056)
Height, machine body, in (mm)	41 (1,035)
Control system	Modular, digital CAN-based PLC
Terminal	Portable remote control
Communication	Radio or cable
Radio	Industrial Bluetooth, class 1
Range, radio, ft (m)	Up to 328 (100)
Battery for remote control	High-capacity Li-ion 1600 mAh
Minimum recommended generator, kW/kVA	50/62
Automatic breaker lubrication	Included on standard version

\*Reach measured on machine with breaker SB 202, from center of rotation to tip of breaker, with machine's arm at maximum extension, in horizontal position.

## RECOMMENDED ATTACHMENTS

DCR 300 | MG 200 | SB 302



# Husqvarna DXR 300

## Applications

- Perfect for demolition and smaller excavation work, both indoors and out.
- Efficient in tough, dusty environments.
- Ideal for demolition of concrete and brick constructions, staircases, roofs, balconies, as well as locations like courtyards.

## Benefits

- Long fixed arm with a stable, durable design needs a minimum of service.
- Great flexibility in performing a variety of demolition projects.
- Low height allows the user to see over the machine during operation and a low center of gravity increases stability.
- Zero exhaust emissions. 100% electric over hydraulic operation.
- Includes two hydraulic outlets at the tool hitch for attachments.



DXR Model	DXR 300
Part No. (breaker not included)	967195610
Part No. (breaker not included, includes extreme heat package)	967195604 (special order)

## Technical Specifications

Power, hp (kW)	30 (22)
Voltage, V	480
Rated current, amps	40.5
Power supply	3-phase
Weight, lbs (kg)	4,321 (1960)
Reach*, ft (m)	17 (5.2)
Flow 60 Hz, g/min (l/min)	17 (65)
System pressure, nominal maximum, psi (bar)	2,901 (200)
System pressure, increased maximum, psi (bar)	3,626 (250)
Variable flow to tools and system, g/min (L/min)	0-17 (0-65)
Pump type	Variable load-sensing axial piston pump
Width, machine body, in (mm)	31 (780)
Length, machine body, including outriggers, in (mm)	81 (2,056)
Height, machine body, in (mm)	41 (1,035)
Control system	Modular, digital CAN-based PLC
Terminal	Portable remote control
Communication	Radio or cable
Radio	Industrial Bluetooth, class 1
Range, radio, ft (m)	Up to 328 (100)
Battery for remote control	High-capacity Li-ion 1600 mAh
Minimum recommended generator, kW/kVA	50/62
Automatic breaker lubrication	Included on standard version

\*Reach measured on machine with breaker SB 202, from center of rotation to tip of breaker, with machine's arm at maximum extension, in horizontal position.

**RECOMMENDED ATTACHMENTS**

**DCR 300 | MG 200 | SB 302**

# Husqvarna DXR 270

## Applications

- Perfect for demolition and smaller excavation work, both indoors and out, as well as pile-driving and work in confined spaces such as basements.
- Efficient in tough environments, like the steel processing industry.
- Handles building demolition in most types of materials.

## Benefits

- Fixed arm with stable, durable design needs a minimum of service. The fixed arm delivers precise positioning of the tool.
- Outriggers with extra wide span for superior stability and high workload.
- Low weight and short chassis make the machine easy to transport and maneuver in tight spaces.
- Zero exhaust emissions. 100% electric over hydraulic operation.
- Includes two hydraulic outlets at the tool hitch for attachments.



DXR Model	DXR 270
Part No. (breaker not included)	967195505
Part No. (breaker not included, includes extreme heat package)	967195504 (special order)

## Technical Specifications

Power, hp (kW)	25 (19)
Voltage, V	480
Rated current, amps	33.5
Power supply	3-phase
Weight, lbs (kg)	3,858 (1750)
Reach*, ft (m)	16 (4.8)
Flow 60 Hz, g/min (l/min)	17 (65)
System pressure, nominal maximum, psi (bar)	2,901 (200)
System pressure, increased maximum, psi (bar)	3,626 (250)
Variable flow to tools and system, g/min (L/min)	0-17 (0-65)
Pump type	Variable load-sensing axial piston pump
Width, machine body, in (mm)	31 (780)
Length, machine body, including outriggers, in (mm)	81 (2,056)
Height, machine body, in (mm)	41 (1,035)
Control system	Modular, digital CAN-based PLC
Terminal	Portable remote control
Communication	Radio or cable
Radio	Industrial Bluetooth, class 1
Range, radio, ft (m)	Up to 328 (100)
Battery for remote control	High-capacity Li-ion 1600 mAh
Minimum recommended generator, kW/kVA	45/56
Automatic breaker lubrication	Included on standard version

\*Reach measured on machine with breaker SB 202, from center of rotation to tip of breaker, with machine's arm at maximum extension, in horizontal position.

## RECOMMENDED ATTACHMENTS

**DCR 300 | MG 200 | SB 202**



# Husqvarna DXR 140

## Applications

- Perfect for demolition and smaller excavation work in concrete and brick structures, both indoors and out. Also suitable for pile-driving, staircases and roof applications.
- Efficient in tough, dirty environments such as steel and cement processing plants.
- Small design enables work in confined spaces, such as basements.

## Benefits

- Easy-to-remove side covers facilitate service and inspection.
- 360° of rotation, based on a hydraulic/electrical swivel technique, allows a more flexible work area.
- Individually controlled outriggers enable it to work on uneven surfaces or close to walls.
- Zero exhaust emissions. 100% electric over hydraulic operation.
- Includes two hydraulic outlets at the tool hitch for attachments.



DXR Model	DXR 140
Part No. (breaker not included)	966529307

## Technical Specifications

Power, hp (kW)	20 (15)
Voltage, V	480
Rated current, amps	24.3
Power supply	3-phase
Weight, lbs (kg)	2,132 (967)
Reach*, ft (m)	12 (3.7)
Flow 60 Hz, g/min (l/min)	13.6 (52)
System pressure, nominal maximum, psi (bar)	2,901 (200)
System pressure, increased maximum, psi (bar)	3,626 (250)
Variable flow to tools and system, g/min (L/min)	0-13.6 (0-52)
Pump type	Variable load-sensing axial piston pump
Width, machine body, in (mm)	30.35 (771)
Length, machine body, including outriggers, in (mm)	63.5 (1,614)
Height, machine body, in (mm)	33.6 (854)
Control system	Modular, digital CAN-based PLC
Terminal	Portable remote control
Communication	Radio or cable
Radio	Industrial Bluetooth, class 1
Range, radio, ft (m)	Up to 328 (100)
Battery for remote control	High-capacity Li-ion 2500 mAh
Minimum recommended generator, kW/kVA	40/50
Automatic breaker lubrication	Included on standard version

\*Reach measured on machine with breaker SB 152, from center of rotation to tip of breaker, with machine's arm at maximum extension, in horizontal position.

## RECOMMENDED ATTACHMENTS

DCR 100 | MG 100 | SB 152

# Remote Demolition Spare Parts

Spare Parts		DXR 310	DXR 300	DXR 270	DXR 140
Adapter plate, SB 302	588608401		X		
Adapter plate, SB 202	588607001	X	X	X	
Adapter plate, SB 152	588611401				X
Battery for remote control	587311602	X	X	X	X
Cable, remote control	589860401	X	X	X	X
Emergency maneuvering unit	587738201	X	X	X	X
Filter, oil	510144501	X	X	X	
Foot pad, rubber	590379901	X	X	X	X
Foot pad, steel	587186301	X	X	X	
Grease, breaker	521917701	X	X	X	X
Grease, quick coupling female	510267801	X	X	X	X
Grease, quick coupling female	510267901	X	X	X	X
Harness, wireless remote control	501793001	X	X	X	X
Harness waist belt, remote control	501793101	X	X	X	X
Quick coupling, female	510268101	X	X	X	X
Quick coupling, male	510268001	X	X	X	X
Remote control	591440101	X	X	X	X
Track, single rubber	505268701	X	X	X	
Track, single rubber	579328401				X
Track, single steel	579217301	X	X	x	
5-pin socket, 32 amp female	531117131				X
5-pin socket, 32 amp male	510277702				X
5-pin socket, 63 amp female	531117132	X	X	X	
5-pin socket, 63 amp male	510277701	X	X	X	



Steel track



Steel foot pad



Rubber track



Emergency maneuver kit



Adapter plate for SM 202



Harness



Remote control



Waist belt

# Additional Feature Kits

Enhanced Cooling: allows DXR to work continuously with full power in higher ambient temperatures.

Hydraulic Option: allows the operator to precisely control one extra hydraulic function.

Heat Protection: protects vital parts from damage caused by radiant heat as well as combustion heat.

Dust Reduction: supplies water to DXR breakers, which is then sprayed next to the breaker to bind airborne dust.

Kits		DXR 310	DXR 300	DXR 270	DXR 140
Enhanced cooling package	586702501	X	X		
Enhanced cooling package	586702701			X	
Kit, cylinder protection C2	576443001	X	X	X	
Kit, cylinder protection C2 or C3	574714601				X
Kit, cylinder protection kit C3	576443101	X			
Kit, cylinder protection kit C3	576443201		X	X	
Kit, dust reduction	583807104	X			
Kit, dust reduction	583807103		X		
Kit, dust reduction	583807102			X	
Kit, dust reduction	583807101				X
Kit, extra hydraulic function	582715001	X			
Kit, extra hydraulic function	582715201			X	
Kit, extra hydraulic function	582715101		X		
Kit, extra hydraulic function	582715301				X
Kit, SB202/302 dust reduction	583807202	X	X	X	
Kit, SB152 dust reduction	583807201				X
Kit, heat package P3	582715401	X			
Kit, heat package P3	582715501		X		
Kit, heat package P3	582715701			X	
Kit, oil tool drain (DC 200)	583807304	X			
Kit, oil tool drain (DC 200)	583807303		X		
Kit, oil tool drain (DC 200)	583807302			X	
Kit, oil tool drain (DC 200)	583807301				X



DXR dust reduction kit



Heat protection package



Enhanced cooling package



Extra hydraulic function kit



Cylinder protection kit - C2+C3

# Crusher Attachments

## Applications

- DCR 300 and DCR 100 are perfect for crushing concrete and brick in buildings, staircases, and roofs where low noise and minimal vibrations are required.

## Benefits

- DCR 300's high power-to-weight ratio makes it one of the strongest crushers of its size on the market.
- DCR 100 is the only product on the market to offer an easy tool/machine with the ability to demolish a 15.7" wall (DXR 140 only).



RECOMMENDED FOR	DXR 310/300/270	DXR 140
<b>Crusher Model</b>	<b>DCR 300</b>	<b>DCR 100</b>
Part No.	966786401	966786301

## Technical Specifications

Jaw opening width, in. (mm)	17 (430)	16-3/4 (425)
Weight including hoses and adapter plate, lbs (kg)	604 (274)	423 (192)
Crushing force, t (kN)	45 (440)	34/32 (335/317)
Depth, in (mm)	7-7/8 (200)	7-7/8 (200)
Maximum cutting No. 9 rebar size, in (mm)	1-1/8 (30)	1 (28)



Crusher pad for DCR 100



Crusher pad for DCR 300



DCR 300 with crusher pads added

Accessories & Spare Parts		DCR 300	DCR 100
Crusher pad	579026501	X	
Crusher pad	579026601		X
Crusher tip	579018501	X	
Rebar cutting edge	579009301	X	
Rebar cutting edge	579024201		X

# Steel Shear Attachment

## Applications

- DSS 200 steel shear is ideal for use in the industrial process industry, as well as demolition of structures, piping, vessels and tanks.

## Benefits







- DSS 200 has a slim design for better access in narrow openings..



<b>RECOMMENDED FOR</b>	<b>DXR 310/300/270/140</b>
<b>Steel Shear</b>	<b>DSS 200</b>
Part No. (includes hose & adapter palte)	967278001

## Technical Specifications

Jaw opening width, in. (mm)	7-3/4 (200)
Weight including hoses and adapter plate, lbs (kg)	396 (180)
Depth, in (mm)	5-1/4 (135)

DSS 200 Capacity	Steel Section	Max Dimensions, in (mm)
	Beam IPE 120	4-3/4 x 2-1/2 (120 x 64)
	Square bar	1-1/8 x 1-1/8 (30 x 30)
	Tube	3 x 1/4 (75 x 5)
	Rebar (max quality steel: 500 MPa/75 ksi)	1 (25)
	Square tube	2-3/8 x 2-3/8 x 1/4 (60 x 60 x 5)
	Channel tube UPE 1	2-1/8 x 4 (55 x 100)

Accessories & Spare Parts		DSS 200
Cutting blade, curved	587019501	X
Cutting blade, straight	587019401	X

REMOTE DEMOLITION



# Drum Cutter Attachment

## Applications

- Made to pulverize rock or concrete when surface profiling, trenching, excavating frozen soil, soft rock excavation in quarries, demolition and dredging.

## Benefits

- High torque gear motor provides high productivity.
- Optimized pick pattern enables tool to deliver maximum force.



RECOMMENDED FOR	DXR 310/300/270/140
<b>Drum Cutter</b>	<b>DC 200</b>
Part No. (includes hoses and adapter plate)	583807001
<b>Must order DC 200 with one of the following kits</b>	
Part No. (Oil tool drain kit - DXR 310)	583807304
Part No. (Oil tool drain kit - DXR 300)	583807303
Part No. (Oil tool drain kit - DXR 270)	583807302
Part No. (Oil tool drain kit - DXR 140)	583807301

## Technical Specifications

Service weight, lbs (kg)	441 (200)
Total width cutting head, in (mm)	20 (500)
Diameter of cutter drum, in (mm)	9 (240)
Number of picks, pcs	56
Maximum cutting force @ 5,075 psi, lbs.	2,835 (1,286)
Maximum torque @ 5,075 psi, lbs.	1,900 (862)
Maximum rock hardness, psi	2,900



# Multi-Grapppler Attachments

## Applications

- Suitable for demolishing masonry or wooden structures. Can pick up materials to sort and load.

## Benefits

- The low weight and high gripping volume help increase performance.
- 360° hydraulic rotary drive.
- The grapple and wear parts are made of carbon steel, making them extremely durable and lightweight.



RECOMMENDED FOR	DXR 310/300/270	DXR 140
<b>Multi Grapppler</b>	<b>MG 200</b>	<b>MG 100</b>
Part No. (includes hoses and adapter plate)	586743001	586742901

## Technical Specifications

Jaw opening width, in. (mm)	29-½ (750)	23-½ (600)
Weight, lbs (kg)	386 (175)	198 (90)
Force, t (kN)	15/15	5.9/0.6
Width, in (mm)	18 (450)	12 (300)



# Bucket Attachments

## Applications/Benefits

- Ideal for excavation and debris removal.
- Attaches easily to DXR in either a standard or reverse setup.
- Mounting bucket in the reverse setup enables DXR to be used as a loader, great for tight areas and clean up.



RECOMMENDED FOR		DXR 310/300/270		
Buckets	Wide	Standard	Narrow	
Part No.	587975701	587310701	587310801	

## Technical Specifications

Weight, lbs (kg)	198 (90)	154 (70)	110 (50)
Width, in (mm)	30 (770)	20 (520)	12 (300)
Volume, gal. (l)	30 (105)	22 (85)	10 (40)



RECOMMENDED FOR		DXR 140		
Buckets	Wide	Standard	Narrow	
Part No.	587310901	587311001	587310802	

## Technical Specifications

Weight, lbs (kg)	132 (60)	128 (58)	110 (50)
Width, in (mm)	30 (770)	20 (520)	12 (300)
Volume, gal. (l)	16 (60)	15 (55)	10 (40)



# Breaker Attachments

## Applications

- Ideal for excavation and debris removal.



RECOMMENDED FOR	DXR 300	DXR 310/300/270	DXR 140
<b>Breakers</b>	<b>SB 302</b>	<b>SB 202</b>	<b>SB 152</b>
Part No. (includes hoses and adapter plate)	586501301	522482401	576189101
Part No. (includes hoses, adapter plate & heat resistant kit)	586702801	586702601	-

## Technical Specifications

Weight, lbs (kg)	661 (300)	441 (200)	309 (140)
------------------	-----------	-----------	-----------

# Breaker Chisel Matrix

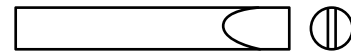
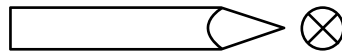

	Breaker	Moil Point (Sizes above 20" are special order*)			Cross Cut Flat Point (Sizes above 20" are special order*)		
		Standard	Overall length 48" (122 cm)	Overall length 72" (183 cm)	Standard	Overall length 48" (122 cm)	Overall length 72" (183 cm)
<b>DXR 140</b>	<b>SB 152</b>	20" (51 cm)			20" (51 cm)		
		587671519	587671504		587671518	587671503	587671505
<b>DXR 270, 310, 300</b>	<b>SB 202</b>	23.5" (60 cm)					
		587671522	587671510	587671512	587671521	587671509	
<b>DXR 300</b>	<b>SB 302</b>	31.5" (80 cm)			31.5" (80 cm)		
		587671524	587671517		587671525	587671516	



	Breaker	Wide chisel	Deck buster
<b>DXR 140</b>	<b>SB 152</b>	20" (51 cm)	20" (51 cm)
		587671520	587671501
<b>DXR 270, 310, 300</b>	<b>SB 202</b>	23.5" (60 cm)	23.5" (60 cm)
		587671523	587671502
<b>DXR 300</b>	<b>SB 302</b>	31.5" (80 cm)	31.5" (80 cm)
		587671526	587671527

\*Chisels over 20" in length are special order items and are not carried in stock. Please allow 10-15 business days for delivery. Cannot be warranted.



# REACH, DXR 310

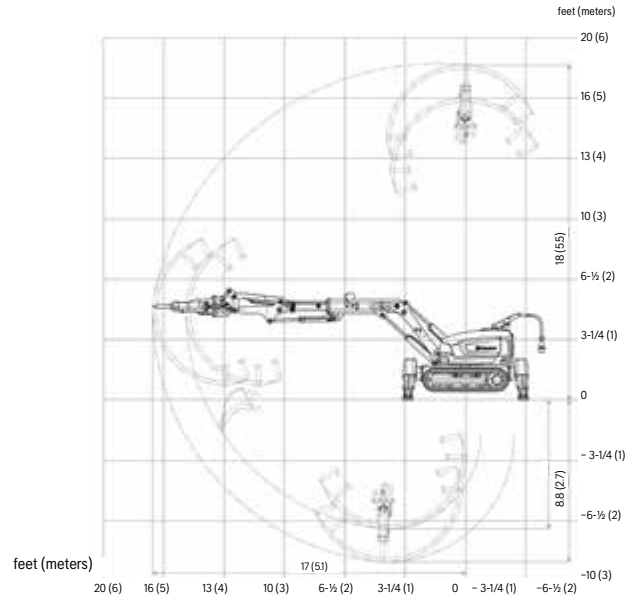

# DIMENSIONS, DXR 310, inches (MM)

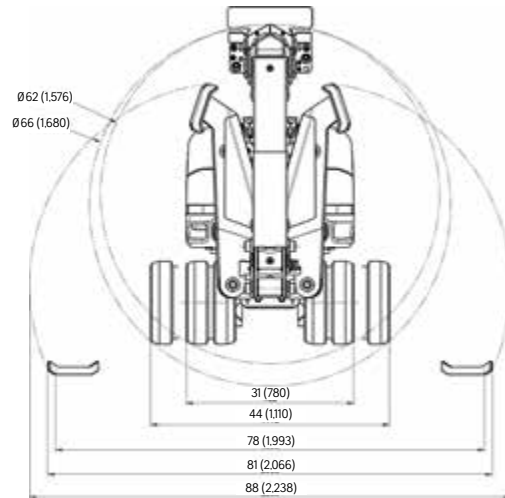
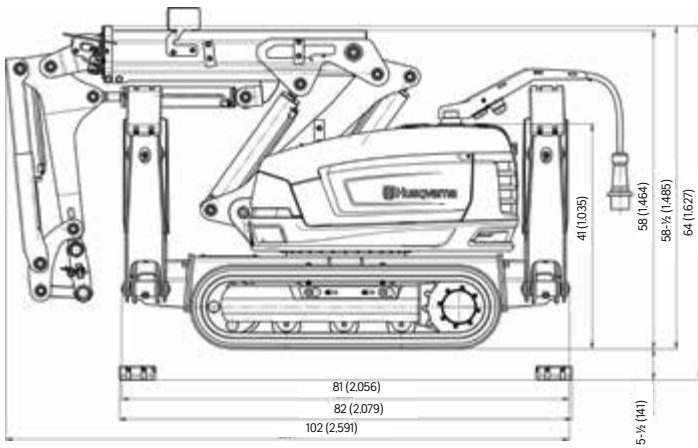

REMOTE  
DEMOLITION



# REACH, DXR 300

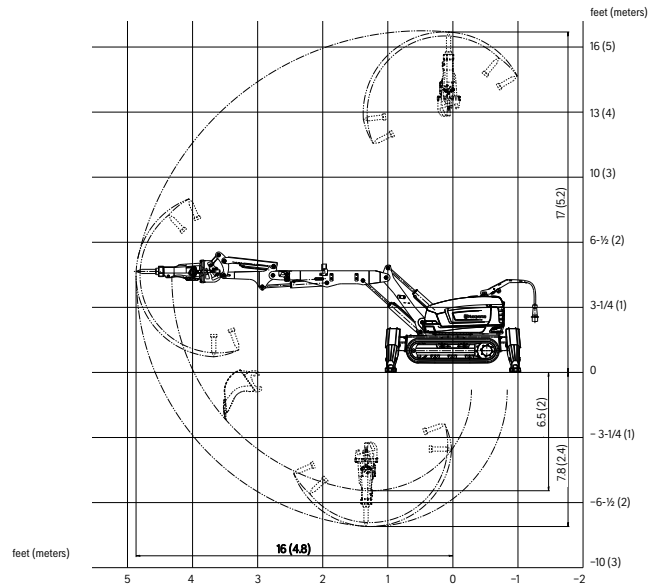

# DIMENSIONS, DXR 300, INCHES (MM)

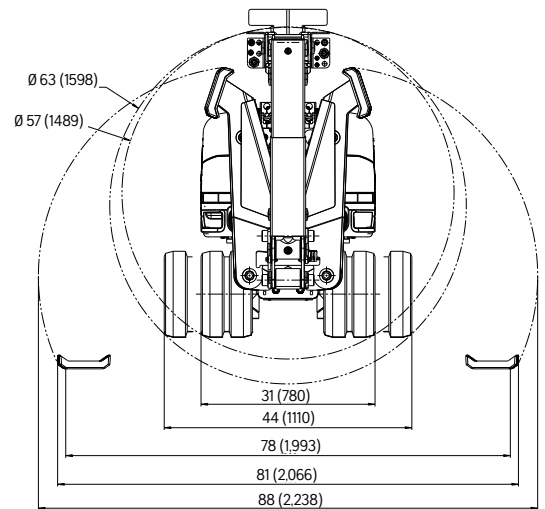
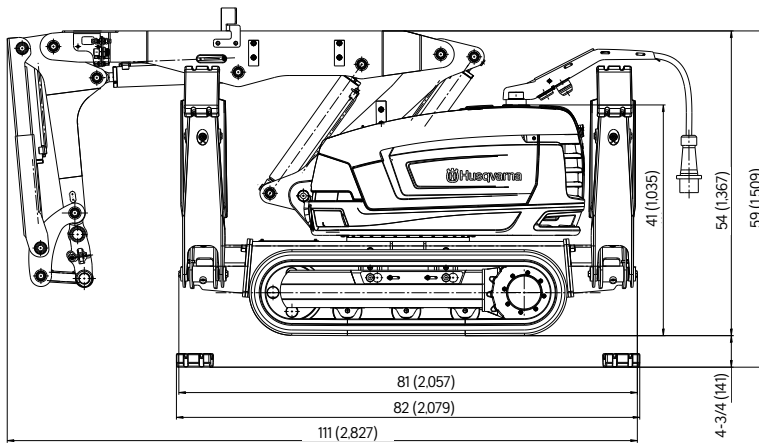

# REACH, DXR 270

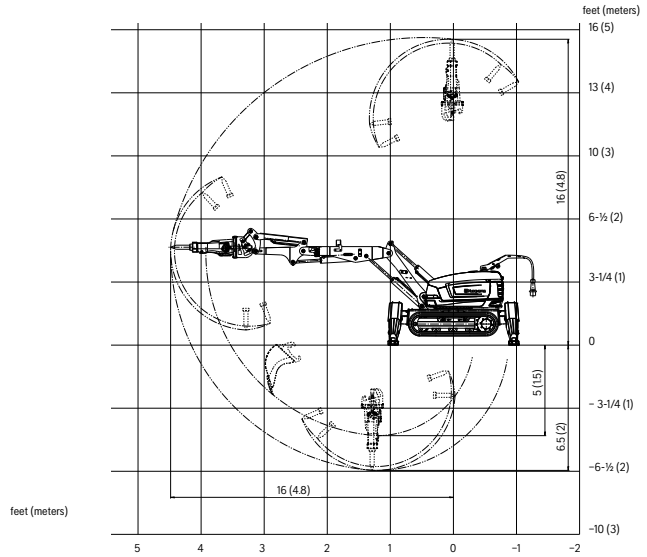

## DIMENSIONS, DXR 270, INCHES (MM)

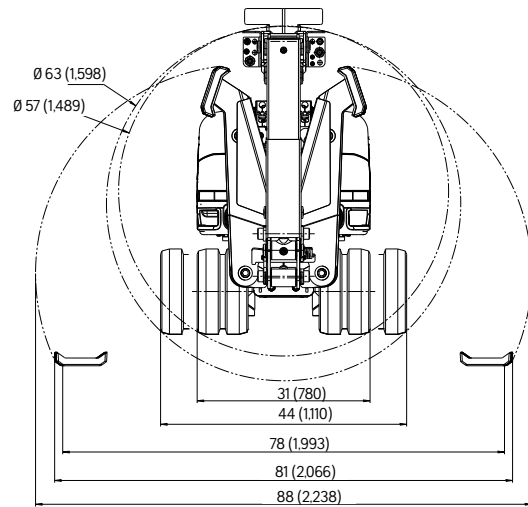
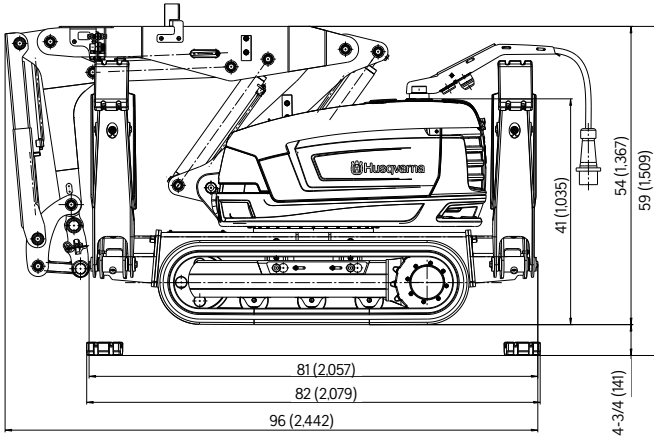

REMOTE  
DEMOLITION

# REACH, DXR 140

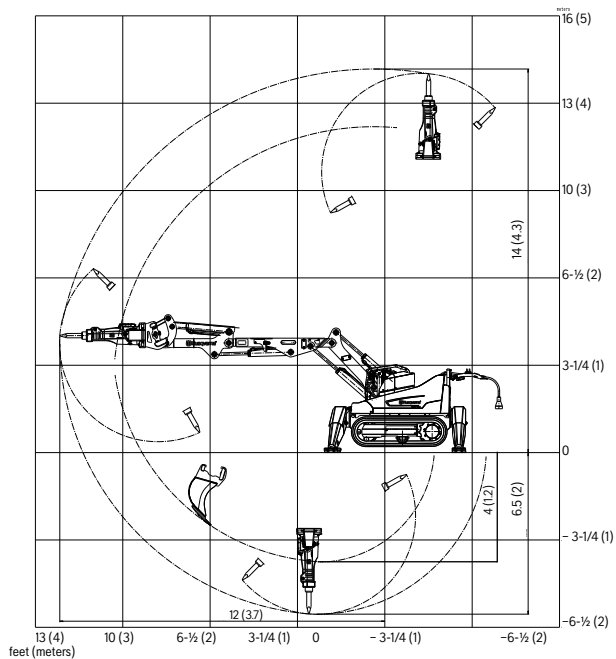

# DIMENSIONS, DXR 140, inches (MM)

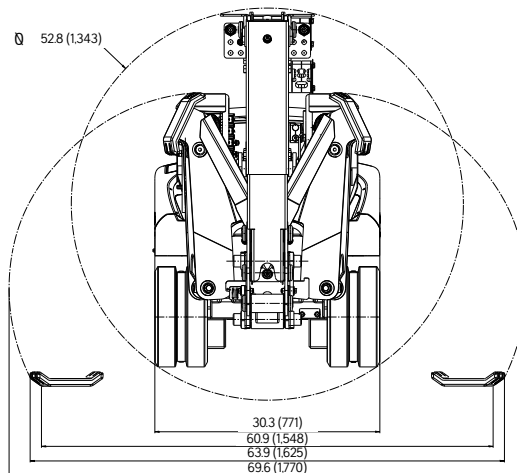
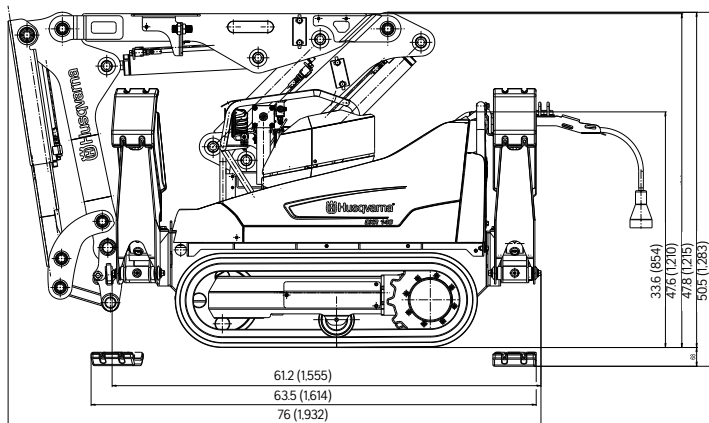

REMOTE  
DEMOLITION

# Protective Equipment

## Technical Gloves

- Excellent strength & great quality
- Spandex fabric back
- Goatskin palm
- High visibility colors
- Reflective crown H
- Reflective piping HD elastic cuff with velcro for secure adjustable fit



## Functional Winter Gloves

- Great for cold weather
- Thinsulate™ 40 grams
- Spandex fabric
- High visibility
- Reflective crown H
- Excellent strength
- Water resistant material
- HD elastic cuff with velcro for secure adjustable fit



### Technical Gloves

Description	Part Number
Technical gloves - medium	589752201
Technical gloves - large	589752202
Technical gloves - Xlarge	589752203

### Functional Winter Gloves

Description	Part Number
Functional winter gloves - medium	-
Functional winter gloves - large	579380810
Functional winter gloves - Xlarge	579380312

## Master Grip Gloves

- Breathable & comfortable
- Grey poly-cotton glove
- Dipped in blue latex
- Provides grip in wet or dry conditions
- Perfect for hot climate



## Xtreme Duty Work Gloves

- Heavy duty pig skin
- Double reinforced split grain leather palm, thumb, and index finger
- Sewn with Kevlar®



### Master Grip Gloves

Description	Part Number
Master grip gloves - medium	531300270
Master grip gloves - large	590635802
Master grip gloves - Xlarge	590635803

### Xtreme Duty Work Gloves

Description	Part Number
Functional winter glove - medium	531300273
Functional winter glove - large	531300274
Functional winter glove - Xlarge	531300275

## Functional XP Pro Gloves

- Synthetic leather palm
- Spandex fabric back
- Reinforced rubberized grip pads on palm & fingertips
- Ventilated finger walls
- High visibility colors
- Reflective crown H
- Reflective piping
- HD elastic cuff with velcro



### Master Grip Gloves

Description	Part Number
Functional XP pro glove - small	584955101
Functional XP pro glove - medium	589752101
Functional XP pro glove - large	589752102
Functional XP pro glove - Xlarge	589752103

# Protective Equipment

## Protective Glasses

- Eva foam-lined frame protects against dust & debris
- Frame color - crystal black
- Lens color - smoke



Protective Glasses	
Description	Part Number
Fortress	501234501

## Protective Glasses

- Sleek modern full frame design for added protection
- Dual mold rubber temple grips for better stability
- Frame color - black
- Lens color - HD blue mirror



Protective Glasses	
Description	Part Number
Black Diamond	501234503

## Protective Glasses

- Sleek modern full frame design for added protection
- Dual mold rubber temple grips for better stability
- Frame color - camo
- Lens color - smoke



Protective Glasses	
Description	Part Number
Woodland	501234504

## Protective Glasses

- Adjustable rubber nosepiece for added comfort
- Dual mold rubber temple grips for better stability
- Frame color - grey & orange
- Lens color - silver mirror



Protective Glasses	
Description	Part Number
Eclipse	501234507

## Protective Glasses

- Sleek modern full frame design for added protection
- Dual mold rubber temple grips for better stability
- Frame color - orange & grey
- Lens color - silver mirror



Protective Glasses	
Description	Part Number
Legacy	501234502

## Protective Glasses

- Half frame style for unobstructed visibility
- Soft, rubber temples & nosepiece
- Frame color - camo
- Lens color - bronze



Protective Glasses	
Description	Part Number
Savannah	501234510

## Protective Glasses

- Dielectric design with extended curved lens protection
- Dual mold rubber temples & adjustable rubber nose piece
- Frame color - black
- Lens color - clear



Protective Glasses	
Description	Part Number
Classic	501234513

## Glasses Accessories

- Lanyard (blue or black): used to hold glasses around neck when not in use
- Microfiber bag: storage & lens cleaning



Protective Glasses	
Description	Part Number
Lanyard (blue)	501250601
Microfiber bag	501250602



# Protective Equipment

## Gear Bag

- Rugged construction with plenty of room for all of your personal protective equipment and miscellaneous items.
- Convenient detachable shoulder strap.



Gear Bag	
Description	Part Number
Bag, trolley Xplorer 90L	531300270

## Backpack

- High quality backpack for all weather.
- Large compartments perfect to hold all your items.



Backpack	
Description	Part Number
Backpack, Xplorer 30L	593258202

## HI-VIZ Hard Hat

- UV protected orange hard hat with 6Pt adjustable suspension
- Hi-Viz orange color for improved visibility
- Meets ANSi Z89.1-1997 class g-e standards



Hi-Viz Hard Hat	
Description	Part Number
Hi-Viz hard hat	593043801
Replacement suspension - 6 point	575557602

## Hearing Protectors\*

- Lightweight, flexible padded headband
- 25dB(A) NRR hearing protectors
- Clamshell packaged
- Must order in master pack quantities of 3
- \*For use without hard hat



Hearing Protectors	
Description	Part Number
Headband hearing protectors	593258202
Hygiene set replacement cup inserts	505665326



# What is a Diamond Blade?

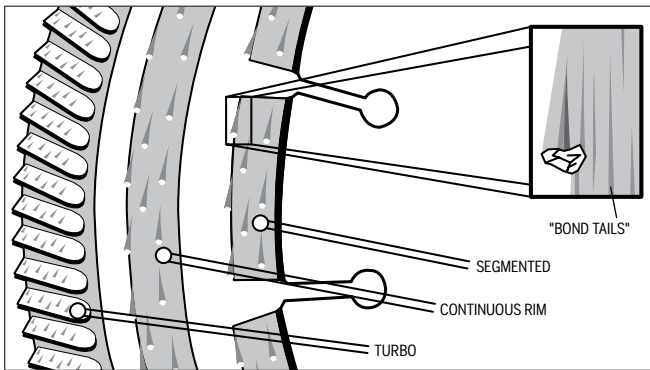

A diamond blade is a circular steel disc with a diamond bearing edge. The edge can have one of three configurations: segmented, continuous rim or turbo.

The blade core is a precision-made, steel disc which may have slots. The slots (also called "gullets") provide faster cooling by allowing water or air to flow between the segments. The slots also allow the blade to flex under cutting pressure.

Most blade cores are tensioned at the factory so the blade will run straight at proper cutting speeds. Proper tension also allows the blade to remain flexible enough to bend slightly under cutting pressure and "snap" back into position. Diamond segments or rims are made up of a mixture of diamonds and metal powders. Diamonds used in blades are almost exclusively manufactured diamonds, in various grit sizes and quality grades.

In the manufacturing process, the metal powder and diamond grit mixture is hot pressed at high temperatures to form a solid metal alloy (called the bond or matrix) in which the diamond grit is retained.

The segment or rim is slightly wider than the blade core. This side clearance allows the cutting edge to penetrate through the material without steel drag.

To attach the diamond rim or segments securely to the steel core, several different processes, brazing, laser welding or a diffusion bond are used.

## 1. BRAZING

Silver solder is placed between the segment or rim and the core. At high temperatures, the solder melts and bonds the two parts together.

## 2. LASER WELDING

The diamond segment and steel blade core are welded (fused) together by a laser beam.

## 3. DIFFUSION BOND

Mechanical bond process guaranteed for normal useful life of the blade.

## HOW DO DIAMOND BLADES WORK?

Diamond blades do not really "cut" like a knife...they grind. During the manufacturing process, individual diamond crystals are exposed on the outside edge and sides of the diamond segments or rim. These exposed surface diamonds do the grinding work. The metal "matrix" locks each diamond in place. Trailing behind each exposed diamond is a "bond tail" which helps support the diamond.

While the blade rotates on the arbor shaft of the saw, the operator pushes the blade into the material. The blade begins to cut through the material, while the material begins wearing away the blade.

Exposed surface diamonds score the material, grinding it into a fine powder. Embedded diamonds remain beneath the surface.

Exposed diamonds crack or fracture as they cut, breaking down into even smaller pieces. Hard, dense materials cause the diamonds to fracture even faster.

The material also begins to wear away the metal matrix through abrasion. Highly abrasive materials will cause the matrix to wear faster, allowing new layers of diamond exposure to continue cutting.

This continuous grinding and wearing process continues until the blade is "worn out." Sometimes a small, unusable part of the segments or rim may remain. It is important to understand that the diamond blade and the material must work together (or interact) for the blade to cut effectively.

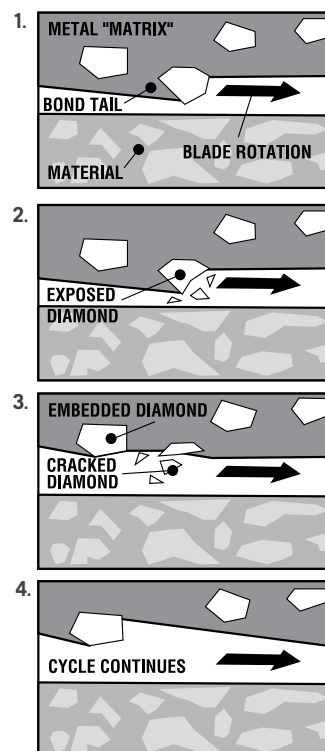

In order for a diamond blade to work properly, the diamond type, quality and grit size must be suited for the saw and the material. The metal matrix must also be matched to the material to be cut.

Blades for cutting hard, dense (less abrasive) materials (such as tile, hard brick, stone or hard-cured concrete) require a softer metal matrix.

The softer metal matrix wears faster, replacing worn-out diamonds fast enough for the blade to keep cutting

Blades for cutting soft, abrasive materials (such as block, green concrete or asphalt) must have a hard metal matrix to resist abrasion and hold the diamonds longer.

# How to Select the Right Diamond Blade?

## BEFORE YOU GET STARTED

Decide which is most important: the initial price of the blade or the cost per cut. For smaller jobs or occasional use, a low priced blade may be preferable. For larger jobs or regular use, a higher priced blade will actually be less expensive to use because it will deliver the lowest cost per cut. For really big jobs, the lowest possible sawing cost (cost per foot) is usually much more important than the initial price. Husqvarna has a grading system to help you identify the different performance levels of blades.

## KNOW THE TYPE AND HORSEPOWER OF THE SAW BEING USED

A list of different types of equipment to use diamond blades on is provided on page 6. There is a corresponding symbol for each, and these symbols are used throughout the catalog to help locate the right blade. Blades that are to be used on power cutters have to be rated at higher rpms. Please refer to the chart on page 264. All Husqvarna high-speed cut-off blades are rated at the appropriate, higher rpms.

## CORRECTLY IDENTIFY WHAT YOU ARE CUTTING

Correctly identifying the material to be cut is the most important factor in choosing a blade. It directly affects the cutting speed and the life of the blade. Diamond blade recommendation charts are found throughout the catalog to help locate the proper blade. Most Husqvarna blades cut a range of materials. For maximum performance (cutting speed and life), the material should be matched to the blade as closely as possible. As a general rule, determine the material which will be cut most often, or the material for which top blade performance is most important.

## CHOOSE WET OR DRY CUTTING

Choosing wet or dry may be a matter of user preference or job requirement. When using a power hand tool such as a power hand saw, it is not safe to use water because of the electrical power source. However for concrete saws, wet cutting is usually preferred because you can cut deeper when using water as a coolant. For tile and masonry saws, either wet or dry cutting blades can be used. For power cutters, dry blades are more popular, but they are often used wet to control dust. Wet blades **MUST** be used with water. Dry blades may be used **EITHER** dry **OR** wet, as the job or equipment allows.

## THE SIGNIFICANCE OF SEGMENT HEIGHT

Total segment heights may be misleading because of non-diamond bearing segment bases necessary for the laser welding or brazing process. That is why Husqvarna shows you exactly how much of each segment has diamonds and can actually be used to cut. Diamond blade segment height by itself is not a true measure of a blade's value. Many other factors affect a blade's performance and consequent value. Consider the diamond size, concentration and quality, the hardness of the bond, the cutting power (torque) of the saw, and how well the blade specification is matched to the material being cut.

## FACTORS INVOLVING CONCRETE

When cutting concrete, several factors influence which diamond blades to choose. These include:

- Compressive strength
- Hardness of the aggregate
- Size of the aggregate
- Abrasivity of the aggregate
- Type of sand
- Steel reinforcing (rebar)
- Green or cured concrete

The guidelines in this section are for general reference only. The best source for information on the characteristics of the concrete to cut is from the original contractor. Contact your local Department of Transportation or City Hall for help in finding this information.

## COMPRESSIVE STRENGTH

Concrete slabs may vary greatly in compressive strength, measured in pounds per square inch (PSI). Most concrete roads are 4,000-6,000 PSI, while typical patios or sidewalks are about 3,000 PSI.

Concrete Hardness	PSI
Critically hard	8,000 or more
Hard	5,000 - 8,000
Medium	4,000 - 6,000
Soft	3,000 or less



# Diamond Blade Performance

## SIZE OF THE AGGREGATE

The size of aggregate affects diamond blade performance. Large aggregates tend to make a blade cut slower. Smaller aggregates tend to make a blade cut faster. The most common sizes of aggregate are:

- Pea Gravel.....Variable in size, usually 3/8" or less in diameter
- 3/4" .....Sieved size
- 1-1/2" .....Sieved size

## HARDNESS OF THE AGGREGATE

There are many different types of rock used as aggregate. Hardness often varies even within the same classification of rock. For example, granite varies in hardness and friability.

The Mohs Scale is frequently used to measure hardness. Values of hardness are assigned from one to ten. A substance with a higher Mohs number scratches a substance with a lower number - higher Mohs Scale numbers indicate harder materials.

The scale below shows the Mohs scale range. Aggregate hardness is one important factor when cutting concrete. Because hard aggregate dulls diamond grit more quickly, segment bonds generally need to be softer when cutting hard aggregate. This allows the segment to wear normally and bring new, sharp diamond grit to the surface. Softer aggregate will not dull diamond grit as quickly, so harder segment bonds are needed to hold the diamonds in place long enough to use their full potential. Most aggregates fall into the 2 to 9 range on the Mohs scale.

## HARDNESS OF THE AGGREGATE CONTINUED

Scores of commonly used aggregates.

Mohs Scale	
1 - Talc	6 - Feldspar
2 - Gypsum	7 - Quartz (Si O <sub>2</sub> )
3 - Calcite	8 - Topaz
4 - Fluorite	9 - Corundum (Al <sub>2</sub> O <sub>3</sub> )
5 - Apatite	10 - Diamond

Mohs Range	Description	Aggregates
8-9	Critically hard	Flint, chert, trap rock, basalt
6-7	Hard	Some river rock, some granites, basalt, quartz, trap rock
4-5	Medium hard	Some granites, some river rock
3-4	Medium	Dense limestone, sandstone, dolomite, marble
2-3	Medium soft	Soft limestone

## TYPE OF SAND

Sand is part of the aggregate mix and determines the abrasiveness of concrete. "Small aggregate" is usually sand. Sand can either be sharp (abrasive) or round (non-abrasive). To determine the sharpness of sand, you need to know where the sand is from. Crushed sand and bank sand are usually sharp; river sand is usually round.

Green concrete is more abrasive than cured concrete because when concrete is not fully cured, sand can easily be scraped off the surface being cut. More loose sand means more abrasiveness.

## STEEL REBAR REINFORCING

Heavy steel reinforcing tends to make a blade cut slower. Less reinforcing tends to make a blade cut faster. Light to heavy rebar is a very subjective term.

### Light Examples:

Wire mesh, single mat

### Medium Examples:

#4 rebar, every 12" on center each way (OCEW), single mat, wire mesh, multi-mat

### Heavy Examles:

#5 rebar, 12" OCEW, single mat | #4 rebar, 12" OCEW, double mat

Heavy rebar can also result from different grades of steel. Typical rebar is grade 40 steel. Grade 60 steel would make the example of #4 medium rebar, above, into a heavy rebar. Rebar gauges are in eighths of an inch - #4 rebar is 1/2" diameter, #5 is 5/8". Where rebar specifications do not exist on a road, pull a core sample before buying a blade.

## GREEN OR CURED CONCRETE

The drying or curing time of concrete greatly affects how the material will interact with a diamond blade. Green concrete is freshly poured concrete that has set up but is not yet fully cured. It is softer and more abrasive than cured concrete. You need a harder bonded blade with undercut protection to cut green concrete. You need a softer bonded blade to cut the same concrete in a cured state. The definition of green concrete can vary widely. Weather, temperature, moisture in the aggregate, time of year and the amount of water in the mix all influence curing time. Concrete now has additives which can either shorten or extend curing time. Consult your mix design to find the relative curing time for your job. As soon as wet concrete sets up and does not spall or ravel, green cutting can begin.



# Aggregate Map

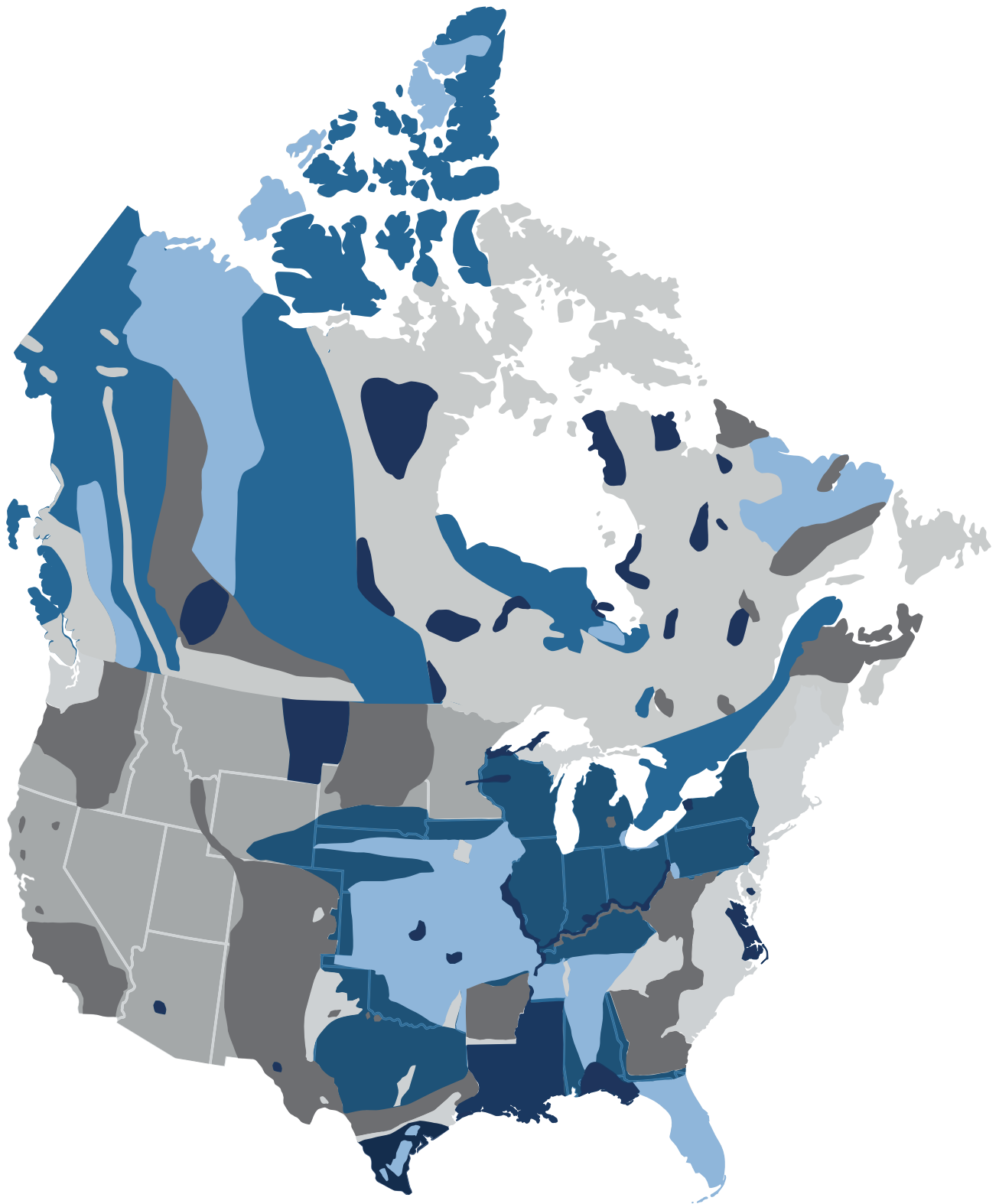

SOFT

MEDIUM SOFT

MEDIUM

MEDIUM HARD

HARD

# Diamond Blade Trouble Shooting

Few Husqvarna diamond blade problems are caused by warranty failures - less than 1/10% (.001). Most problems result from:

- Using the wrong blade for the job
- Using the blade improperly
- Equipment problems

This trouble shooting guide will help identify, diagnose and correct diamond blade problems. The following are samples of some of the problems you may encounter in the field, with a cause and remedy guide to diagnose and correct these problems.

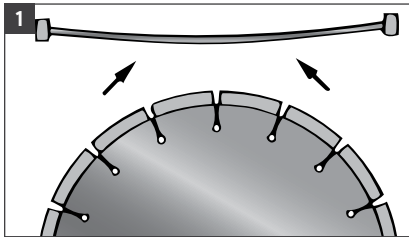

Loss of tension

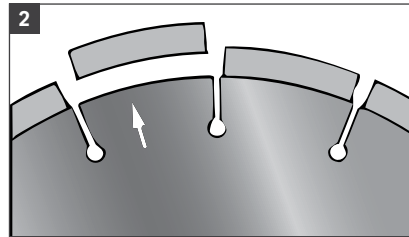

Segment loss

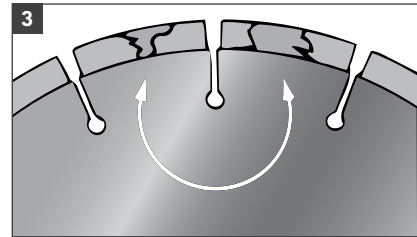

Cracked segment

## BLADE ISSUE 1) LOSS OF TENSION

blade does not stay straight while running, but wobbles

COULD BE CAUSED BY...	POTENTIAL REMEDY
Blade being used on misaligned saw.	Check for proper saw alignment.
Blade is excessively hard for the material being cut, creating stress on the steel center.	Double-check blade was made to cut the material. If not, select a new blade.
Utilizing blade flanges that are under size or not the same diameter, creating uneven pressure on the center.	Check that proper size and identical diameter flanges are being used. The blade collar diameter should be a minimum of 1/6" of the maximum diameter of blade.
Wrong RPMs.	Use the tachometer to ensure the bladeshaft is turning at the proper RPMs for the blade.
Blade improperly mounted on arbor shoulder and has become bent when flanges are tightened.	Hold the blade securely on the arbor shoulder until the outside flange and nut are firmly tightened.

## BLADE ISSUE 2) SEGMENT LOSS

one of more segments fall off from the blade core

COULD BE CAUSED BY...	POTENTIAL REMEDY
Blade is too hard for the material it is cutting, which creates excessive dullness making the segment pound off or fatigue.	Switch to a softer bond blade.
Worn blade flanges fail to provide proper support and cause the blade to deflect.	Replace both blade flanges.
The material slips during cutting, which twists or jams the segment loose.	Make sure the material is secured and stable while cutting.
Out-of-round blade rotation results in pounding, caused by worn arbor or bad bearings in the shaft.	Replace worn arbor and/or bearings.
Overheating can usually be detected by blue color on steel center and generally confined to the area where the segment was lost.	Check the water system for adequate volume and for obstructions in the water system. For dry cutting, it may be necessary to make shallower cuts and allow the blade to run freely every few minutes in order to let the air cool it.

**REPAIR NOTE:** It is possible to replace two or three missing diamond segments, providing the steel center is not cracked or undercut badly. If many segments are missing, or if there is less than 50% of blade life remaining, repairing the diamond blade may not be economical.

**Be certain to eliminate mechanical or operational problems before installing replacement blades.**

## BLADE ISSUE 3) CRACKED SEGMENTS

cracks form in one or more segments

COULD BE CAUSED BY...	POTENTIAL REMEDY
Blade is too hard for the material it is cutting.	Switch to a softer bond blade.

# Diamond Blade Trouble Shooting

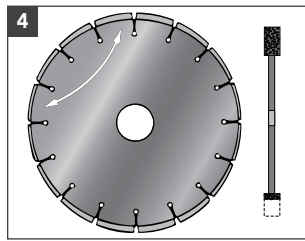

Eccentricity

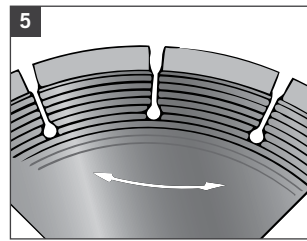

Overheated Blade

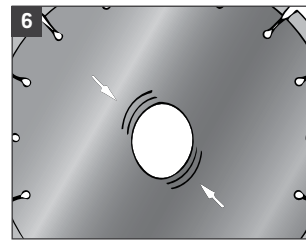

Arbor hole out-of-round



Blade won't cut

## BLADE ISSUE 4) ECCENTRICITY

blade is out-of round resulting in uneven wear rate of segments

COULD BE CAUSED BY...	POTENTIAL REMEDY
The bond is too hard for the material being cut. The hard bond retains the diamonds and they begin to round off, causing the blade to becoming dull.	Change to a softer bond, which will wear away more readily. This allows the dull diamonds to be released and the sharp, new cutting edges to become exposed.
The saw bladeshaft may have a groove scored in it, caused by a blade spinning between the flanges. A new blade, installed on the arbor shaft, will seat into the groove and immediately run eccentrically when the saw starts.	Replace the worn shaft.
If the bladeshaft bearings are worn, the shaft and mandrel will run eccentrically causing the blade to wear out-of-round. This happens most often with concrete saws when proper lubrication of the bearings is neglected.	Install new bladeshaft bearings. In some cases it might also be necessary to replace the bladeshaft if it is worn out of alignment.

## BLADE ISSUE 5) OVERHEATED BLADE

blade comes hot

COULD BE CAUSED BY...	POTENTIAL REMEDY
Adequate coolant was not provided.	Check water supply for adequate volume and for obstructions in the water system. Use dry blades ONLY for shallow cutting (1-2" deep) or step cutting.

## BLADE ISSUE 6) ARBOR HOLE OUT-OF-ROUND

arbor hole stretches so that it isn't a circle

COULD BE CAUSED BY...	POTENTIAL REMEDY
Saw arbor badly worn due to improperly seated blades	Before tightening flange, make sure blade is seated correctly (on arbor shoulder).
Blade flange not properly tightened permitting blade to rotate on the shaft.	Always wrench tighten the arbor nut. Never hand tighten. Always use hex nuts, never use wing nuts.
Blade flanges or arbor shaft worn and not providing proper blade support.	Check blade flanges or arbor shaft for damage or excessive wear. Both flanges should be no less than that recommended by the manufacturer. Replace worn parts.

## BLADE ISSUE 7) BLADE WON'T CUT

blade spins in the cut without cutting the material

COULD BE CAUSED BY...	POTENTIAL REMEDY
Blade is too hard for materials being cut (for example - block or general purpose blade being used for extended period on hard brick. Asphalt blade being used to cut hard concrete).	Consult dealer or manufacturer for proper blade to cut the materials.
Insufficient power to permit blade to cut properly.	Make sure belts are not loose, and saw is producing enough horsepower.
Blade has become dull because of continuous use on fairly hard or vitrified material.	Consult the diamond tool supplier or manufacturer.
Blade segments appear to still have plenty of life, but blade won't cut.	Some harder-bonded blades designed for abrasive materials require a non-diamond bearing section at the base of the diamond segment for better adherence to the steel core. A blade used to this stage has worn out in the normal manner and should be replaced.

# Diamond Blade Trouble Shooting

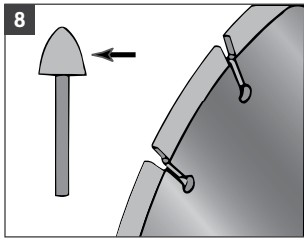

Excessive Wear

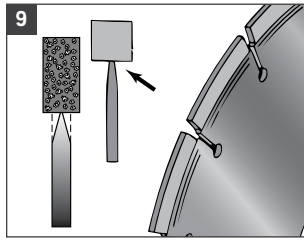

Undercutting

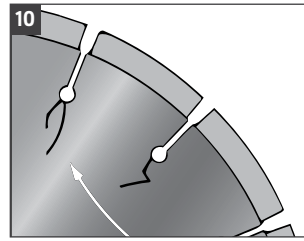

Cracked Core

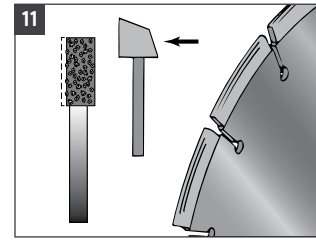

Uneven Segment War

## BLADE ISSUE 8) EXCESSIVE WEAR

segments are worn too quickly

COULD BE CAUSED BY...	POTENTIAL REMEDY
If diamonds are highly exposed, you could be using the wrong blade on highly abrasive material.	Consult dealer or manufacturer for the proper blade specification for abrasive material.
If diamonds are highly exposed, there could be a lack of sufficient coolant to the blade.	If saw is equipped with a water pump, make sure it is functioning properly. Check water supply at blade.
Wearing out-of-round accelerates wear. Usually this can be caused by bad bearings, worn shaft or using a blade too hard for the materials being cut.	Check bearings and arbor. If worn, replace with new parts before installing another blade.
Insufficient power caused by loose V-belts, or improper RPMs	Tighten belts taut or replace any worn belts.

## BLADE ISSUE 9) UNDERCUTTING

steel core wears faster than the diamond segment, usually where the core and segment are joined resulting in segment loss.

COULD BE CAUSED BY...	POTENTIAL REMEDY
Highly abrasive material grinding against the core during operation. Most highly abrasive materials contain larger volumes of sand.	The flow of swarf (abrasive cuttings) must be distributed over a wider area, away from the critical segment area with undercut retardant segments or other types of undercut protectors specially positioned around the steel center to change the pattern of constant abrasion. Although successful in most cases, undercut protectors do not provide 100% protection.

## BLADE ISSUE 10) CRACKED CORE

small, sometimes hairline, cracks form on the core

COULD BE CAUSED BY...	POTENTIAL REMEDY
Blade is too hard for material being cut.	Use correct blade with softer bond.
If diamonds are highly exposed, there could be a lack of sufficient coolant to the blade.	If saw is equipped with a water pump, make sure it is functioning properly. Check water supply at blade.
Excessive cutting pressure, jamming or twisting the blade in the cut can cause the blade core to bend or flex. When subjected to extreme stress and metal fatigue, the blade's steel core will eventually crack.	The saw operator should use steady, even feed pressure, and be careful not to twist or jam the blade in the cut.
Overheating through inadequate water supply or improper use of dry cutting blades.	Use adequate water to cool wet-cutting diamond blades. Allow adequate airflow around dry-cutting diamond blades to prevent overheating. NEVER USE A BLADE WITH A CRACKED CORE!

## BLADE ISSUE 11) UNEVEN SEGMENT WARE

segments are worn on one side, reducing side clearance

COULD BE CAUSED BY...	POTENTIAL REMEDY
It is usually caused by misalignment of the saw or a lack of sufficient water on both sides of the blade.	Check saw alignment. Clean water system, make certain that water is properly applied to the leading edge of the blade flanges. If machine is equipped with a water pump, check to see if it is supplying enough water.
Blade is worn out-of-round due to bad bearings, worn arbor or excessive dulling condition. See excessive wear.	Replace bearings or worn arbor as required.

# Cutting Depths & Operating Speeds

Diameter (Inches)	Cutting Depth
<b>Concrete Saw Blades</b>	
7"	1-1/2"
8"	2"
12"	3-5/8"
14"	4-5/8"
16"	5-5/8"
18"	6-5/8"
20"	7-5/8"
24"	9-5/8"
26"	10-5/8"
30"	11-3/4"
36"	14-3/4"
42"	17-1/2"
48"	19-3/4"
<b>Wall &amp; Hand Saw Blades</b>	
14"	4-5/8"
18"	6-1/2"
24"	9-1/2"
30"	11-1/2"
36"	14-1/2"
42"	17-1/2"
48"	20-3/4"

Diameter (Inches)	Cutting Depth
<b>Masonry Saw Blades</b>	
14"	5"
18"	7"
20"	8"
<b>Tile Saw Blades</b>	
4"	3/4"
4-1/2"	1"
5"	1-1/4"
6"	1-3/4"
7"	2-1/4"
8"	2-3/4"
9"	3-1/4"
10"	3-3/4"
<b>Power Hand Saw Blades</b>	
3-3/8"	1/2"
4"	1"
4-1/2"	1-1/4"
5"	1-1/2"
7"	2-1/2"
8"	3"
<b>High-Speed Saw Blades</b>	
12"	4"
14"	5"
16"	6"

Dia.	Recommended Operating Speed (RPM)*	Maximum Safe Speed (RPM)**
4"	9,072	15,000
4-1/2"	8,063	13,300
5"	7,257	12,000
6"	6,048	10,185
7"	5,184	8,730
8"	4,536	7,640
9"	4,032	6,790
10"	3,629	6,115
12"	3,024	5,095
12"HS†		6,300
14"	2,592	4,365
14"HS†		5,460
16"	2,268	3,820
16"HS†		4,725
18"	2,016	3,395
20"	1,814	3,055
22"	1,649	2,780
24"	1,512	2,550
26"	1,396	2,350
28"	1,296	2,185
30"	1,120	2,040
32"	1,134	1,910
36"	1,008	1,700
42"	864	1,455
48"	756	1,275

Note: Diamond blade cutting depths listed above are approximate. Actual cutting depth will vary with the exact blade diameter or saw type (or brand), or the exact diameter of the blade collars (flanges). Cutting depth will also be reduced if saw components (motor housing, blade guard) extend below the blade collars (flanges).

†HS is for high-speed diamond blades.

\*Based on 9,500 sfpm (surface feet per min) – the general optimum performance range for cutting concrete and masonry products is +10%. For hard, dense materials such as stone and tile, the optimum performance speed is 10-25% less than the speeds shown above. Bladeshaft speeds (rpms at no load) for most tools will be higher than the recommended operating speeds shown above. Under normal sawing conditions, the actual bladeshaft speed of the tool will slow down under load, and should fall within the optimum speed range.

\*\*This speed (rpm) represents the max safe speed [in revolutions per minute (rpm)] at which each blade can be used. Before using any blade, make sure the bladeshaft (arbor) speed or the tool is within the "maximum safe" limit of that blade.



# Expanding Blade Life & Improving Performance

Dry cutting diamond blades may be used dry, eliminating the need for water tanks, water hoses or wet slurry clean-up. These blades depend on airflow around the blade to prevent excessive heat build-up during cutting.

Use dry diamond blades for "intermittent" sawing. After every 10 to 15 seconds of cutting, take pressure off the blade and allow it to run back up to full speed for several seconds. This "cooling" interval allows air to flow around the blade and dissipate the heat. Use dry diamond blades ONLY for shallow cutting (1-2" deep) or step cutting (making several shallow passes to reach the full depth required).

Husqvarna dry cutting diamond blades are also designed to cut equally well wet, if the job or equipment permits. Wet cutting diamond blades MUST be used with water to prevent excessive heat build-up during cutting. Using water on the blade also reduces dust and helps remove cuttings.

A continuous water flow is critical. Using "wet" blades without water, even for a few seconds, causes excessive heat and blade damage, and creates a safety hazard. Check the saw or tool carefully before using a wet cutting diamond blade. Make sure it is safe to use the saw or tool with water.

## Abrasive Blade Information

Husqvarna abrasive products are available in a variety of shapes, sizes and specifications for a wide range of cutting, grinding and finishing applications.

### WHAT IS AN ABRASIVE WHEEL?

A bonded abrasive wheel is a self-sharpening grinding (or cutting) tool composed of hard abrasive grains held together by a bonding material.

### ABRASIVE GRAIN TYPES

Aluminum oxide is a tough, wedge-shaped, man-made ceramic powder used for cutting or grinding metal, carbon steel, alloys, bronze and similar materials. Silicon carbide is a hard, sharp, man-made ceramic powder used for cutting or grinding concrete, masonry, stone and similar materials.

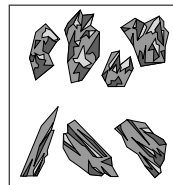

### BONDING MATERIAL

The bond in most Husqvarna abrasives is a synthetic resin which holds the wheel together and supports the exposed surface grains.

### REINFORCING MATERIAL

Woven fiberglass cloth reinforcing provides added strength and flexibility. One or more layers of reinforcing are used, depending on the application.

### WHEEL TYPES

Wheel types are identified with a numeric code in the specifications.

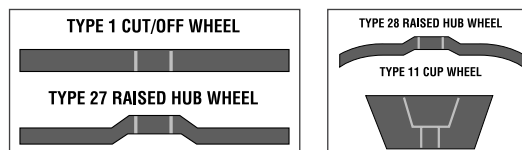

### GRIT SIZES

Abrasive grain grit sizes are included in the specifications for Husqvarna raised hub wheels, cup wheels, grinding stones and fiber sanding discs.

GRIT SIZE (22 - 24 - 30 - 36)



# Cutting Depths & Operating Speeds

## BOND HARDNESS

The hardness of an abrasive wheel represents the bond strength of the wheel and the wheel's ability to hold on to abrasive grains under cutting or grinding loads. Standard abrasive industry classifications use letter codes to indicate the relative hardness of wheels.



## HOW DO ABRASIVES WORK?

- 1) As the wheel contacts the material, exposed surface grains grind away small chips of the material.
- 2) As the wheel grinds, the material causes the surface grains to fracture, exposing new, sharp cutting points. The material also wears away the bond between the grains.
- 3) Eventually the surface grains are used up. The old grains are released as the bond wears away, and new grains are exposed.

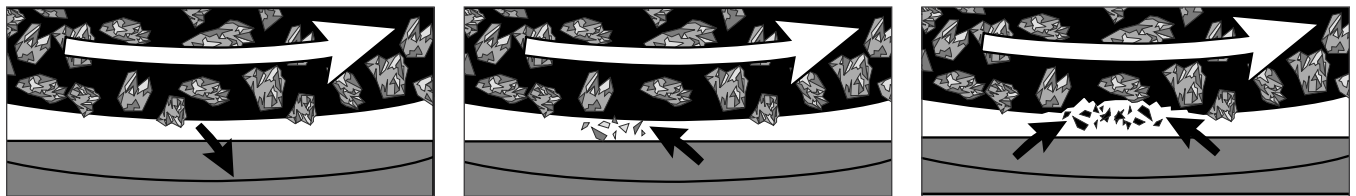

## MAXIMUM OPERATING SPEEDS FOR ABRASIVE WHEELS

Blade Diameter (in)	Type 1 Reinforced Cut-Off Wheels	High Speed Blades	Type 27 & 28 Wheels	Type 11 Cup Wheels
4"	19,000	-	15,000	9,050
4.5"	13,300	-	13,300	-
5"	12,000	-	12,000	7,255
6"	10,000	-	10,000	6,050
7"	8,600	-	8,600	-
8"	7,500	-	-	-
9"	6,800	6,800	6,800	-
10"	6,110	-	-	-
12"	5,095	6,300	-	-
14"	4,365	5,460	-	-
16"	3,820	4,500	-	-
18"	3,395	-	-	-

# Diamond Drill Bit Information/Extension Cords

Always secure the drill rig either with a mechanical anchor, vacuum system or by use of the jack screw. NEVER stand on the base and drill without anchoring. Level the drill rig by use of the base leveling screws, and a small level attached to the column permanently or by a magnetic strip on the level. This procedure will ensure a perpendicular hole. Never let the bit spin in the hole without applied pressure. This will cause the diamonds to round off and the bit segments will heat and glaze over. Turn on water before starting the drill motor. Otherwise, the water jacket seals heat up and become brittle, losing water. When your bit encounters steel (rebar), relax pressure about 1/3 and allow the bit to cut at its own rate. **DO NOT PUSH THE BIT.**

When drilling high PSI concrete or concrete with very hard aggregate (i.e., river rock, flint rock, etc.), the bit will sometimes glaze over. To open or redress the bit, do one of the following:

- Decrease water by 1/2 for a few minutes and as the bit starts to increase speed, gradually increase the water until the flow is back to the original state.
- Pour masonry sand into the slurry then follow the above directions.
- Add a sandblast media such as "Black Beauty" to the slurry and follow the above directions.
- Drill the bit into a cement block, soft vitrified grinding wheel or cinder block. Repeat the procedure until the bit is open again.

When finished drilling, turn the water down very low and back the core bit out of the hole with the motor running.

SYMPTOM	COULD BE CAUSED BY...	POTENTIAL REMEDY
Loss of segment	Bit too hard for the material it is drilling, cause it to pound and fatigue	Use a softer bond if possible. Increase motor RPM if possible.
	Overheating due to insufficient water for cooling and flushing.	Increase water flow to where slurry is milky and flows easily.
	Machine setup is not rigid or loose material is in the cut and the bit segment hangs.	Tighten anchor, check vacuum system for proper vacuum pressure.
	Snagging cable, when drilling prestressed concrete.	Use a bit more segments, such as a Husqvarna B735 PS prestressed core bit.
Segment cracking	Bit is too hard for the material being drilled.	Use a softer bit if possible. Increase motor RPM.
	Machine setup is not rigid.	Tighten anchor, check vacuum system.
Barrel cracking	Too much feed pressure.	Back off on the pressure.
	Segment too hard for material being drilled.	Use bit with softer segment.

## EXTENSION CORD SIZE IN AMERICAN WIRE GAUGE (AWG)

3 Conductor with ground (S0/SJ type cord, length in feet)							2 Conductor with ground (S0 type cord, length in feet)						
3-PHASE, FLA	25	50	75	100	150	200	1-PHASE, FLA	25	50	75	100	150	200
71-10	16	14	12	10	10	8	10-50	18	18	12	10	10	8
101-15	14	12	10	10	8	6	51-10	14	12	12	10	10	10
151-20	12	10	10	8	6	6	101-15	10	10	10	10	10	8
201-25	10	10	8	8	6	6	151-20	10	10	10	10	8	8
251-30	8	8	8	6	6	4	201-25	10	10	10	10	8	6
301-35	8	8	6	6	4	4	251-30	10	10	10	8	6	6
351-40	6	6	6	6	4	2	301-35	8	8	8	8	6	6
401-45	6	6	6	6	4	2	351-40	8	8	8	8	6	6
451-50	4	4	4	4	4	2	401-45	6	6	6	6	6	4

Degrees F	Degrees C	Multiplier
87-95	31-35	104%
96-104	36-40	110%
104-113	41-45	115%

The above tables are based on S0/SJ type cord (Power cord for portable tools and equipment) in an ambient temperature of 86° F (30° C). For higher operating temperatures, use the chart to the right with multipliers for tool amperage. All power cord connectors must be in accordance with NEC standards. Generators must be commercial or industrial type generators and be capable of handling the wattage required for starting the portable tools or equipment. Check and comply with all local codes and regulations when using portable generators.

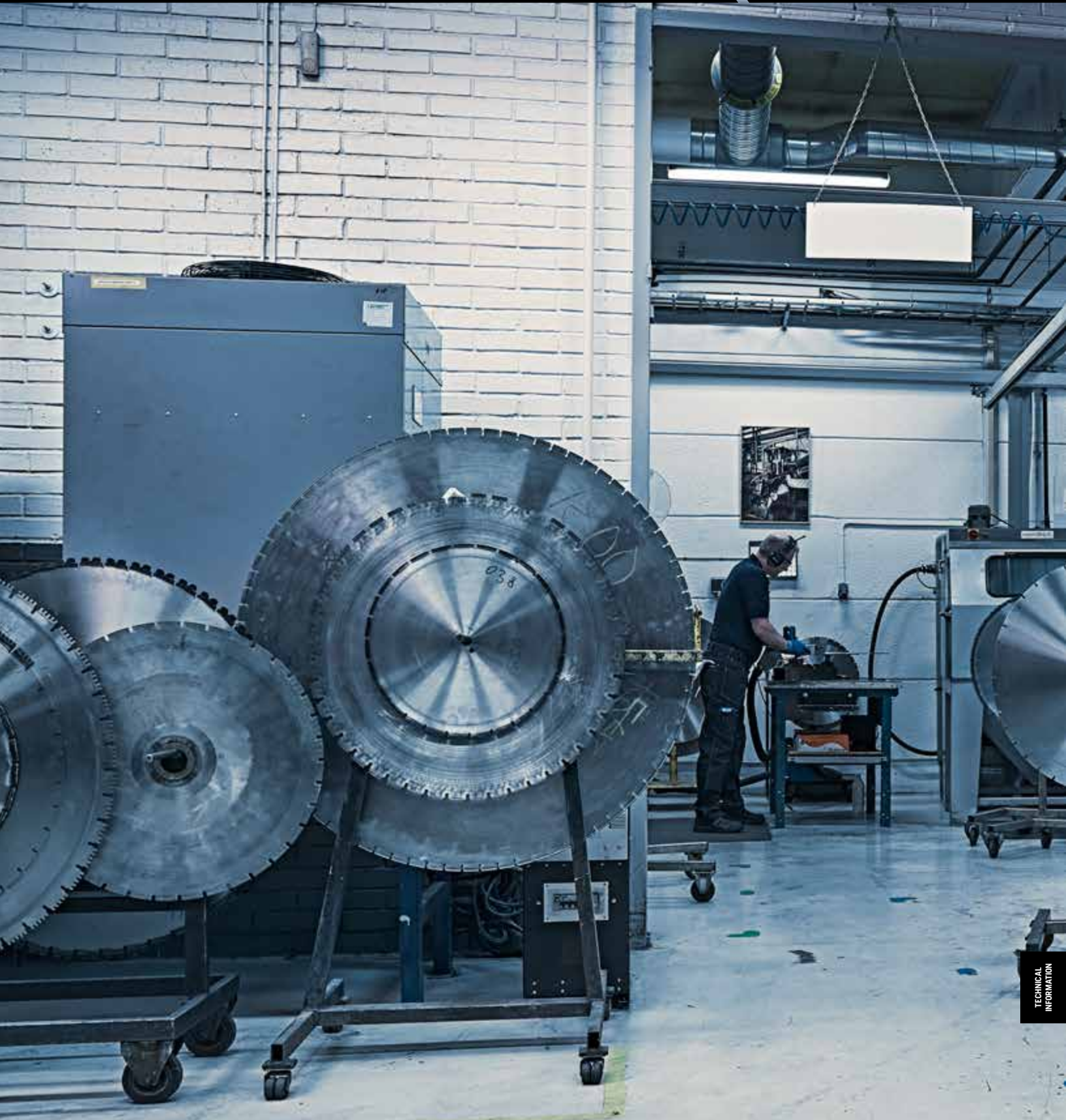

Covered by one or more of the following U.S. Patents  
 4769201, 4889675, 4928662, 4938201, 5056499, 5086750, 5184597, 5303688, 5305729, 5373834, 5441033, 5505189, 5507273, 5570677, 5575271, 5579754,  
 5582899, 5603310, 5660161, 5664553, 5666939, 5689072, 5803071, 6892719, 6990972, 7073495, 7163010, 728115. Other U.S. and foreign patent pending.



