

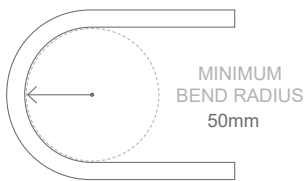

## NEON MICRO ARC | WHITE | SILICONE

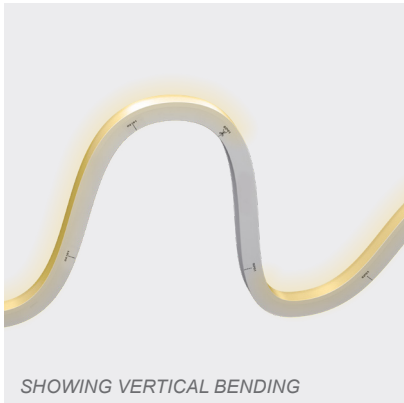

### VERTICAL BENDING

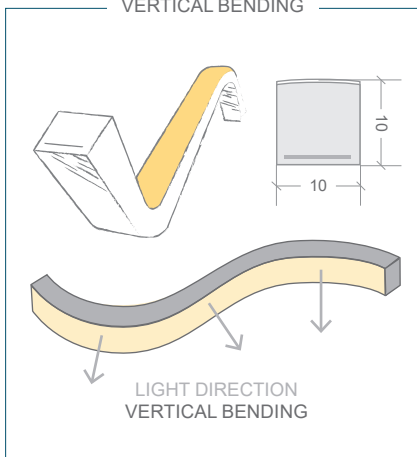

### HORIZONTAL BENDING

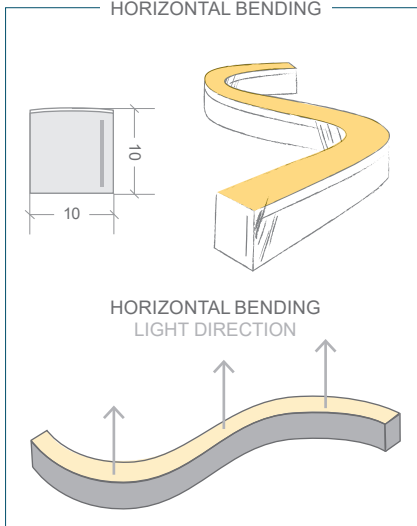

Neon is a broad range of silicone encapsulated LED ribbons with a variety of light emissions and casings that closely reference glass neon tube.

Neon Micro Arc is a square W10 × H10mm model available in either vertical or horizontal bending. Perfect for cove lighting, or architectural features in exterior and interior applications.

Neon is made to order, check with our team for lead times.

### APPLICATIONS

- Theatres, bars, restaurants, & retail
- Cove lighting
- Micro Architectural features
- Exterior or interior installations

### FEATURES

- Neon Micro Arc comes in two versions: vertical bending & horizontal bending
- UV & flame resistant

CODE	COLOUR	LUMENS
BL-LS-4850S-30	WARM WHITE 3000K +/- 150K	≥220lm/m
BL-LS-4850S-30-HB		≥210lm/m
BL-LS-4850S-40	NATURAL WHITE 4000K +/- 175K	≥220lm/m
BL-LS-4850S-40-HB		≥210lm/m
BL-LS-4850S-57	COOL WHITE 5700K +/- 335K	≥220lm/m
BL-LS-4850S-57-HB		≥210lm/m

*ELECTRICAL & OPTICAL DATA VARIANCE +/- 10%. SOLD BY THE METRE. IES FILES AVAILABLE. 2200K, 2700K & 3500K AVAILABLE BY REQUEST. HB = HORIZONTAL BENDING.*

### POWER & TEMP

LED WATTS	4.5W/m
INPUT VOLTS	24V DC Constant voltage
OPERATING TEMP. (ENVIRONMENT)	-40°C ~ +65°C

MAX. RUN PER POWER FEED	<b>IP20 Swivel Connector</b> 10m using one feed 20m using two feeds <b>IP67 Injection Connection</b> 15m using one feed 30m using two feeds
-------------------------	--

### LIGHT & LIFE

CRI	≥80
BEAM ANGLE	160°
LED PER METRE	144
SOURCE LIFE	50,000 hours
WARRANTY	5 years

### PHYSICAL PARAMETERS & CONTROL

MINIMUM BEND RADIUS	50mm
BEND DIRECTION	Vertical bending or Horizontal bending (HB)
DIMENSIONS	W10 × H10mm
INGRESS PROTECTION	IP20 or IP67 Protection established by use of connection type <i>Dimensions of connectors shown on installation guide</i> SEE PAGE 2.
CUTTING LENGTH	83.3mm
HOUSING	UV & flame resistant white silicone with opal diffuser
MOUNTING	Profile / clips available SEE PAGE 3.
CONTROL	Dimmable by PWM signal

## NEON MICRO ARC | WHITE | CONNECTIONS

Neon products are IP rated based on the fitted connections (power feed / end caps).

Bright Light recommend using Slimline injection moulding for the best result, a clean finish and IP67 rating. These are fitted at factory during the production process and can not be altered once produced - **ensure all lengths are double-checked before ordering.**

If on-site cutting is required (due to lengths being unknown in advance or site design alterations), IP20 swivel connector fittings can be used instead. Swivel Connectors can be fitted on-site and offer an IP20 rating (interior only).

Power feed connectors are priced & supplied with 1metre cable as standard. Please specific at time of quoting if alternate lengths are required.

### SLIMLINE INJECTION MOULDING CONNECTIONS | IP67 SILICONE

**RECOMMENDED**



REQUIRES FITTING AT FACTORY.  
EXACT LENGTH REQUIRED BEFORE PRODUCTION

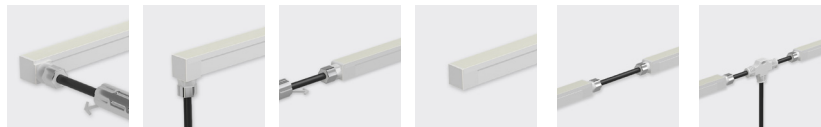

SIDE FEED      BOTTOM FEED      TOP END FEED      END CAP      300MM FLEXIBLE CONNECTOR      T FEED

### SWIVEL CONNECTIONS | IP20 SILICONE

**ON-SITE FITTING**



FITTING ON-SITE - WHERE LENGTHS ARE UNKNOWN IN ADVANCE.

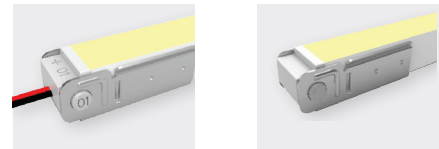

TOP END FEED      END CAP  
01      02

WHITE - HORIZONTAL BENDING	BL-LS-4851	BL-LS-4852	BL-LS-4854
WHITE - VERTICAL BENDING	●	●	●

## NEON MICRO ARC | MOUNTING ACCESSORIES

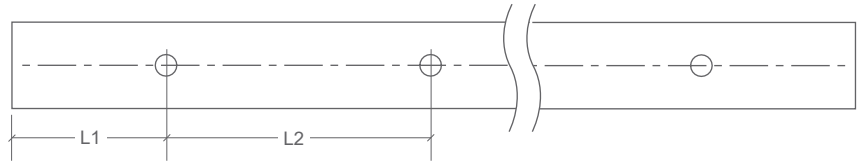

CODE	ACCESSORY	L1	L2	HOLE DIMENSIONS	HOLE NUMBER
BL-LS-4858	PLASTIC AND ALUMINIUM PROFILE 2M	100mm	200mm	Ø3.5mm	10
BL-LS-4855	PLASTIC AND ALUMINIUM MOUNTING CLIP 35MM	17.5mm	–	Ø3.5mm	1
BL-LS-4841	SERRATED ALUMINIUM PROFILE 2 METRE	100mm	200mm	4×10mm	10
BL-LS-4840	SERRATED ALUMINIUM PROFILE 1 METRE	100mm	200mm	4×10mm	5
BL-LS-4842	SERRATED ALUMINIUM CLIP 20MM	10mm	–	4×10mm	1
BL-LS-4869	HORIZONTAL BENDABLE SERRATED ALUMINIUM PROFILE 1 METRE	116.5mm	98.8mm	Ø4.2mm	10

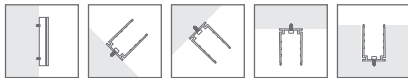
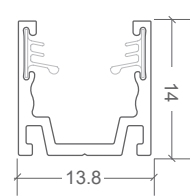
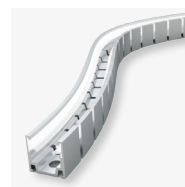
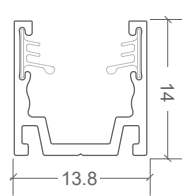
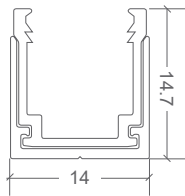
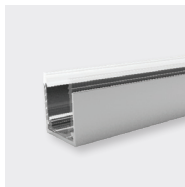

PLASTIC AND ALUMINIUM PROFILE 2M / CLIP

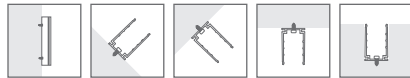

SERRATED ALUMINIUM PROFILE / CLIP



HORIZONTAL BENDABLE SERRATED ALUMINIUM PROFILE 1M